

# User's manual ACS255 drives (0.5...20 hp) (600V Variants)



## List of related manuals

Option manuals and guides	Code (English)
<i>ACS255 user's manual for 115-480V variants</i>	3AXD10000528266

You can find manuals and other product documents in PDF format on the Internet. Go to [www.abb.com/drives](http://www.abb.com/drives) and select Document Library. You can browse the library or enter selection criteria, for example a document code, in the search field. For manuals not available in the Document library, contact your local ABB representative

ACS255 drives  
0.5...20 hp

## **User's manual**

3AXD10000528265 Rev A  
EN  
EFFECTIVE: 2016-09-13



# 1. Table of Contents

---

<i>ACS255 – IP20 (600V Variants) EASY START-UP GUIDE</i>	<u>7</u>
<i>ACS255 – IP66 (600V Variants) EASY START-UP GUIDE</i>	<u>8</u>
<b>2. Safety</b>	<b><u>10</u></b>
What this chapter contains	<u>10</u>
Use of warnings	<u>10</u>
Safety in installation and maintenance	<u>10</u>
Safety in start-up and operation	<u>11</u>
<b>3. General Information and Ratings</b>	<b><u>13</u></b>
3.1. Type designation key	<u>13</u>
3.2. Drive model numbers – IP20	<u>14</u>
3.3. Drive model numbers – IP66	<u>14</u>
<b>4. Mechanical Installation</b>	<b><u>15</u></b>
4.1. General	<u>15</u>
4.2. Before Installation	<u>15</u>
4.3. UL Compliant Installation	<u>15</u>
4.4. Mechanical dimensions and weights	<u>15</u>
4.5. Guidelines for Enclosure mounting (IP20 Units)	<u>17</u>
4.6. Mounting the Drive – IP20 Units	<u>17</u>
4.7. Guidelines for mounting (IP66 Units)	<u>18</u>
4.8. Removing the Terminal Cover	<u>18</u>
4.9. Routine Maintenance	<u>18</u>
<b>5. Electrical Installation</b>	<b><u>19</u></b>
5.1. Grounding the Drive	<u>19</u>
5.2. Wiring Precautions	<u>20</u>
5.3. Incoming Power Connection	<u>20</u>
5.4. Compatibility with IT (ungrounded) and corner-grounded TN systems	<u>21</u>
5.5. Drive and Motor Connection	<u>22</u>
5.6. Motor Terminal Box Connections	<u>22</u>
5.7. Motor Thermal overload Protection.	<u>22</u>
5.8. Control Terminal Wiring	<u>22</u>
5.9. Connection Diagram	<u>23</u>
5.10. Safe Torque Off	<u>24</u>
<b>6. Managing the Keypad</b>	<b><u>28</u></b>
6.1. Keypad Layout and Function	<u>28</u>
6.2. Changing Parameters	<u>28</u>

6.3.	Resetting Parameters to Factory Default Settings	29
6.4.	Advanced Keypad Operation ShortCuts	30
6.5.	Drive Operating Displays	30
<b>7.</b>	<b>Quick Start-up and Control</b>	<b>31</b>
7.1.	Quick Start-up Terminal Control	31
7.2.	Quick Start-up Keypad Control	31
7.3.	Sensorless Vector Speed Control Mode	32
<b>8.</b>	<b>Application Macros</b>	<b>33</b>
8.1.	Overview of macros	33
8.2.	Macro wiring configurations.	34
<b>9.</b>	<b>Parameters</b>	<b>38</b>
9.1.	Parameter Structure	38
9.2.	Parameters in the Short parameter mode	39
9.3.	Read Only Status parameters	41
9.4.	Parameters in the Long parameter mode	43
9.5.	Preventing un-authorized parameter editing.	54
<b>10.</b>	<b>Serial communications</b>	<b>55</b>
10.1.	RJ45 Connector Pin Assignment	55
10.2.	Modbus RTU Communications	55
<b>11.</b>	<b>Technical Data</b>	<b>59</b>
11.1.	Environmental	59
11.2.	Input/Output Current ratings and fuses	59
11.3.	Overload	59
11.4.	Additional Information for UL Approved Installations	60
11.5.	Derating Information	60
<b>12.</b>	<b>Appendix: Permanent magnet synchronous motors (PMSMs)</b>	<b>61</b>
<b>13.</b>	<b>Troubleshooting</b>	<b>62</b>
13.1.	Fault messages	62

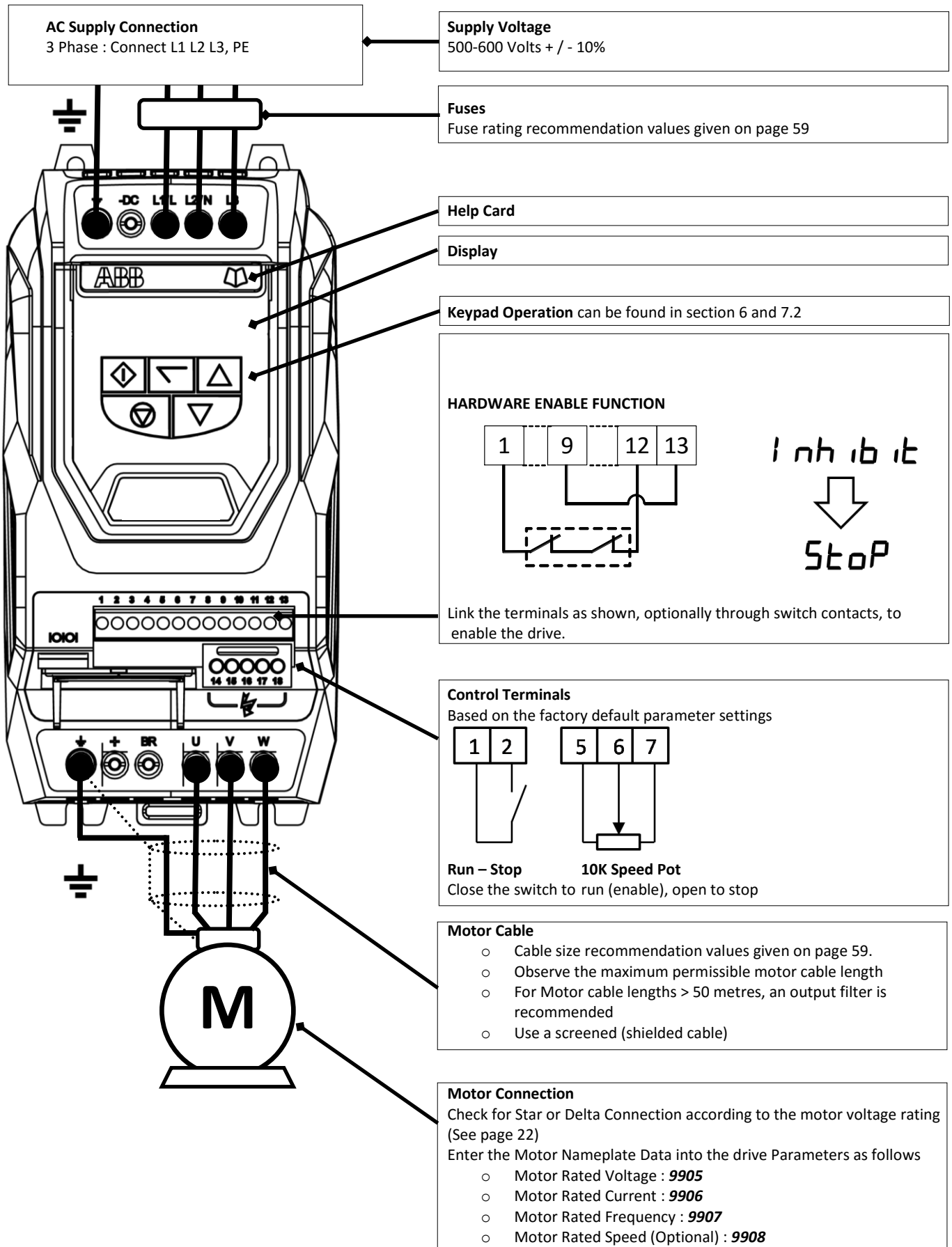

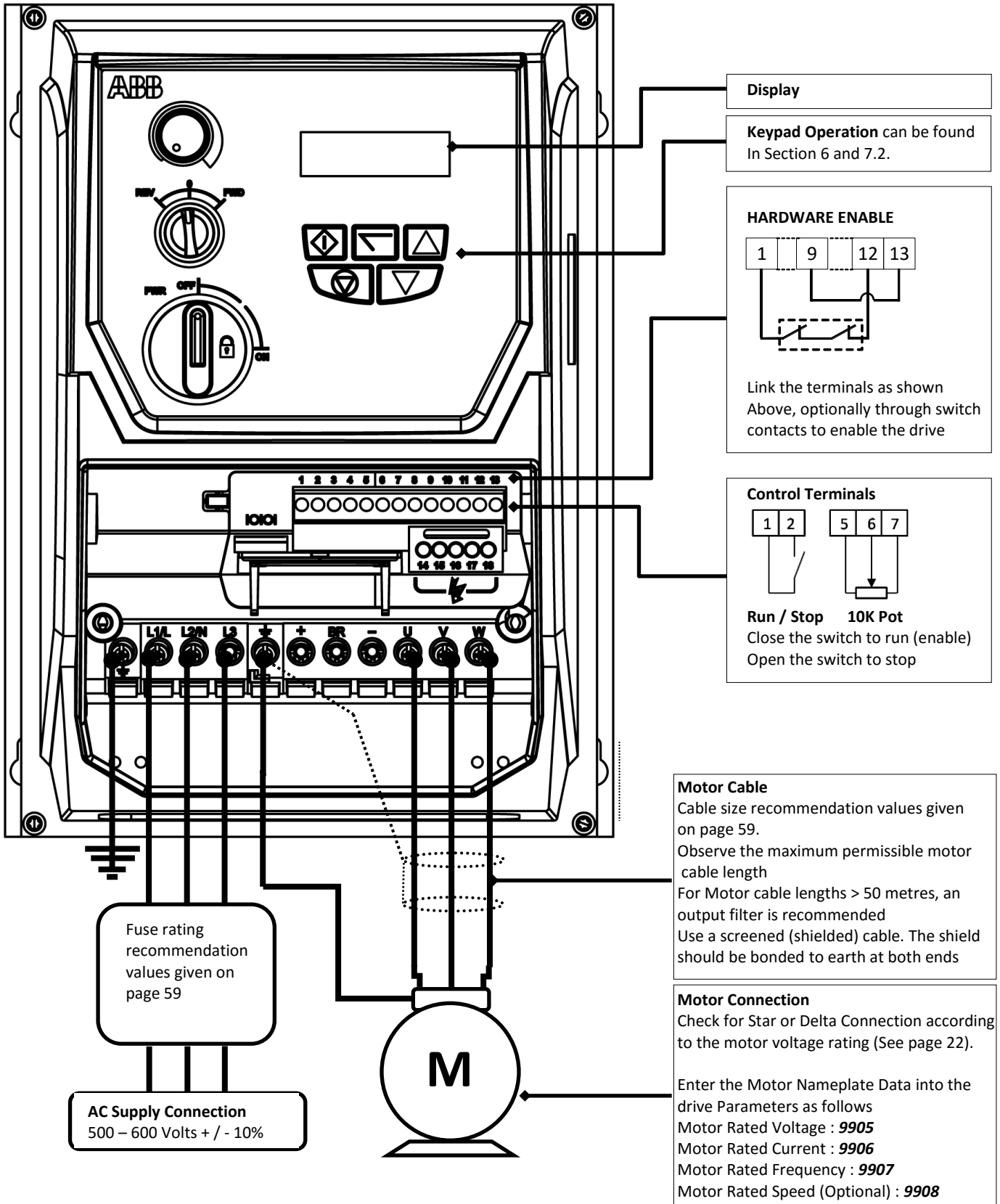

**Display**

**Keypad Operation** can be found In Section 6 and 7.2.

**HARDWARE ENABLE**

1 9 12 13

Link the terminals as shown Above, optionally through switch contacts to enable the drive

**Control Terminals**

1 2 5 6 7

**Run / Stop 10K Pot**  
Close the switch to run (enable)  
Open the switch to stop

**Motor Cable**  
Cable size recommendation values given on page 59.  
Observe the maximum permissible motor cable length  
For Motor cable lengths > 50 metres, an output filter is recommended  
Use a screened (shielded) cable. The shield should be bonded to earth at both ends

**Motor Connection**  
Check for Star or Delta Connection according to the motor voltage rating (See page 22).  
Enter the Motor Nameplate Data into the drive Parameters as follows  
Motor Rated Voltage : **9905**  
Motor Rated Current : **9906**  
Motor Rated Frequency : **9907**  
Motor Rated Speed (Optional) : **9908**

Fuse rating recommendation values given on page 59

**AC Supply Connection**  
500 – 600 Volts +/- 10%

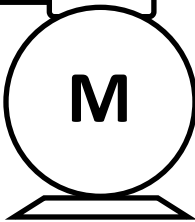



### Declaration of Conformity:

ABB Drives Ltd hereby states that the ACS255 product range conforms to the relevant safety provisions of the following council directives:

2014/30/EU (EMC) and 2014/35/EU (LVD)  
2011/65/EU (RoHS)

EN 61800-5-1: 2007	Adjustable speed electrical power drive systems. Safety requirements. Electrical, thermal and energy.
EN 61800-3 2 <sup>nd</sup> Ed: 2004 / A1:2012	Adjustable speed electrical power drive systems. EMC requirements and specific test methods
EN 55011: 2007	Limits and Methods of measurement of radio disturbance characteristics of industrial, scientific and medical (ISM) radio-frequency equipment (EMC)
EN60529 : 1992	Specifications for degrees of protection provided by enclosures

### STO Function

ACS255 incorporates a hardware STO (Safe Torque Off) Function, designed in accordance with the standards listed below.

Standard	Classification	Independent Approval
EN 61800-5-2:2007	Type 2	*TUV
EN ISO 13849-1:2006	PL "d"	
EN 61508 (Part 1 to 7)	SIL 2	
EN60204-1	Uncontrolled Stop "Category 0"	
EN 62061	SIL CL 2	

**\*Note :** TUV Approval of the "STO" function is relevant for drives which have a TUV logo applied on the drive rating label.

### Electromagnetic Compatibility

It is the responsibility of the installer to ensure that the equipment or system into which the product is incorporated complies with the EMC legislation of the country of use. Within the European Union, equipment into which this product is incorporated must comply with the EMC Directive 2004/108/EC. When using an ACS255 with an internal or optional external filter, compliance with the following EMC Categories, as defined by EN61800-3:2004 can be achieved:

Drive Type / Rating	EMC Category – Conducted Emissions		
	First Environment Category C1	First Environment Category C2	Second Environment Category C3
ACS255..	Use additional External EMC Filter		
<b>Note</b>	Compliance with EMC standards is dependent on a number of factors including the environment in which the drive is installed, motor switching frequency, motor, cable lengths and installation methods adopted.		
	For motor cable lengths greater than 100m, an output dv / dt filter must be used, please refer to the (please refer to the <a href="http://www.abb.com/ProductGuide/">http://www.abb.com/ProductGuide/</a> for further details).		
	Vector Speed and Torque control modes may not operate correctly with long motor cables and output filters. It is recommended to operate in V/F mode only for cable lengths exceeding 50m.		

All rights reserved. No part of this User Guide may be reproduced or transmitted in any form or by any means, electrical or mechanical including photocopying, recording or by any information storage or retrieval system without permission in writing from the publisher.

### Copyright ABB Drives Ltd © 2016

The manufacturer accepts no liability for any damage caused during or resulting from transport, receipt of delivery, installation or commissioning. The manufacturer also accepts no liability for damage or consequences resulting from inappropriate, negligent or incorrect installation, incorrect adjustment of the operating parameters of the drive, incorrect matching of the drive to the motor, incorrect installation, unacceptable dust, moisture, corrosive substances, excessive vibration or ambient temperatures outside of the design specification.

Contents of this User Guide are believed to be correct at the time of printing. In the interest of a commitment to a policy of continuous improvement, the manufacturer reserves the right to change the specification of the product or its performance or the contents of the User Guide without notice.

**This User Guide is for use with version 2.0 Firmware.**

### User Guide Revision A

**This user guide is the "original instructions" document. All non-English versions are translations of the "original instructions".**

The manufacturer adopts a policy of continuous improvement and while every effort has been made to provide accurate and up to date information, the information contained in this User Guide should be used for guidance purposes only and does not form the part of any contract.

## 2. Safety

---

### What this chapter contains

This chapter contains the safety instructions which you must follow when installing, operating and servicing the drive. If ignored, physical injury or death may follow, or damage may occur to the drive, motor or driven equipment. Read the safety instructions before you work on the unit.

### Use of warnings

Warnings caution you about conditions which can result in serious injury or death and/or damage to the equipment and advice on how to avoid the danger. The following warning symbols are used in this manual:



**Electricity warning** warns of hazards from electricity which can cause physical injury and/or damage to the equipment.



**General warning** warns about conditions, other than those caused by electricity, which can result in physical injury and/or damage to the equipment.

### Safety in installation and maintenance

These warnings are intended for all who work on the drive, motor cable or motor.

#### Electricity safety



**WARNING!** Ignoring the instructions can cause physical injury or death, or damage to the equipment.

**Only qualified electricians are allowed to install and maintain the drive!**

- Never work on the drive, motor cable or motor when input power is applied. After disconnecting the input power, always wait for 10 minutes to let the intermediate circuit capacitors discharge before you start working on the drive, motor or motor cable.

Always ensure by measuring with a multimeter (impedance at least 1 Mohm) that:

1. There is no voltage between the drive input phases L1, L2 and L3 and the ground.
2. There is no voltage between terminals + and BR and the ground.

- Do not work on the control cables when power is applied to the drive or to the external control circuits. Externally supplied control circuits may carry dangerous voltage even when the input power of the drive is switched off.
- Do not make any insulation or voltage withstand tests on the drive.
- Be sure the system is properly grounded before applying power. Do not apply AC power before you ensure that all grounding instructions have been followed. Electrical shock can cause serious or fatal injury

**Note:**

Even when the motor is stopped, dangerous voltage is present at the power circuit terminals L1, L2, L3 and U, V, W and + and BR.

---

## General safety

---



**WARNING!** Ignoring the following instructions can cause physical injury or death, or damage to the equipment.

- The drive is not field repairable. Never attempt to repair a malfunctioning drive; contact your local ABB representative or Authorized Service Centre for replacement.
- Make sure that dust from drilling does not enter the drive during the installation. Electrically conductive dust inside the drive may cause damage or lead to malfunction.
- Ensure sufficient cooling.

## Safety in start-up and operation

These warnings are intended for all who plan the operation, start up or operate the drive.

---







**WARNING!** Ignoring the following instructions can cause physical injury or death, or damage to the equipment.

- Before adjusting the drive and putting it into service, make sure that the motor and all driven equipment are suitable for operation throughout the speed range provided by the drive. The drive can be adjusted to operate the motor at speeds above and below the speed provided by connecting the motor directly to the power line.
- Do not activate automatic fault reset functions if dangerous situations can occur. When activated, these functions reset the drive and resume operation after a fault.
- Do not control the motor with an AC contactor or disconnecting device (disconnecting means); use instead the control panel start and stop keys and or external commands (I/O). The maximum allowed number of charging cycles of the DC capacitors (that is, power-ups by applying power) is two per minute.

**Note:**

- When parameter **1103** PRIMARY COMMAND SOURCE MODE is not set to 1 or 2, the stop key on the control panel will not stop the drive. To stop the drive open terminal 2 of the drive control terminals.
-

**Please read the IMPORTANT SAFETY INFORMATION below, and all Warning and Caution information elsewhere.**

	<b>Danger : Indicates a risk of electric shock, which, if not avoided, could result in damage to the equipment and possible injury or death.</b>		<b>Danger : Indicates a potentially hazardous situation other than electrical, which if not avoided, could result in damage to property.</b>
	<p>This ACS255 variable speed drive is intended for professional installation and commissioning into complete equipment or systems as part of a fixed installation. If installed incorrectly it may present a safety hazard. The ACS255 uses high voltages and currents, carries a high level of stored electrical energy, and is used to control mechanical plant that may cause injury. Close attention is required to system design and electrical installation to avoid hazards in either normal operation or in the event of equipment malfunction. Only qualified electricians are allowed to install and maintain this product.</p> <p>System design, installation, commissioning and maintenance must be carried out only by personnel who have the necessary training and experience. They must carefully read this safety information and the instructions in this Guide and follow all information regarding transport, storage, installation and use of the ACS255, including the specified environmental limitations.</p> <p>Do not perform any flash test or voltage withstand test on the ACS255. Any electrical measurements required should be carried out with the ACS255 disconnected.</p> <p>Electric shock hazard! Disconnect and ISOLATE the ACS255 before attempting any work on it. High voltages are present at the terminals and within the drive for up to 10 minutes after disconnection of the electrical supply. Always ensure by using a suitable multimeter that no voltage is present on any drive power terminals prior to commencing any work.</p> <p>Where supply to the drive is through a plug and socket connector, do not disconnect until 10 minutes have elapsed after turning off the supply.</p> <p>Ensure correct grounding connections and cable selection as per defined by local legislation or codes. The drive may have a leakage current of greater than 3.5mA; furthermore the earth cable must be sufficient to carry the maximum supply fault current which normally will be limited by the fuses. Suitably rated fuses should be fitted in the mains supply to the drive, according to any local legislation or codes.</p> <p>Do not carry out any work on the drive control cables when power is applied to the drive or to the external control circuits.</p> <p>The "Safe Torque Off" Function does not prevent high voltages from being present at the drives power terminals.</p>		
	<p>Within the European Union, all machinery in which this product is used must comply with the Machinery Directive 2006/42/EC, Safety of Machinery. In particular, the machine manufacturer is responsible for providing a main switch and ensuring the electrical equipment complies with EN60204-1.</p> <p>The level of integrity offered by the ACS255 control input functions – for example stop/start, forward/reverse and maximum speed, is not sufficient for use in safety-critical applications without independent channels of protection. All applications where malfunction could cause injury or loss of life must be subject to a risk assessment and further protection provided where needed.</p> <p>The driven motor can start at power up if the enable input signal is present.</p> <p>The STOP function does not remove potentially lethal high voltages. ISOLATE the drive and wait 10 minutes before starting any work on it. Never carry out any work on the Drive, Motor or Motor cable when the input power is still applied.</p> <p>The ACS255 can be programmed to operate the driven motor at speeds above or below the speed achieved when connecting the motor directly to the mains supply. Obtain confirmation from the manufacturers of the motor and the driven machine about suitability for operation over the intended speed range prior to machine start up.</p> <p>Do not activate the automatic fault reset function on any systems whereby this may cause a potentially dangerous situation.</p> <p>IP66 drives provide their own pollution degree 2 environments. IP20 drives must be installed in a pollution degree 2 environment, mounted in a cabinet with IP54 or better.</p> <p>ACS255s are intended for indoor use only.</p> <p>When mounting the drive, ensure that sufficient cooling is provided. Do not carry out drilling operations with the drive in place, dust and metal shavings from drilling may lead to damage.</p> <p>The entry of conductive or flammable foreign bodies should be prevented. Flammable material should not be placed close to the drive</p> <p>Relative humidity must be less than 95% (non-condensing).</p> <p>Ensure that the supply voltage, frequency and number of phases correspond to the rating of the ACS255 as delivered.</p> <p>Never connect the mains power supply to the Output terminals U, V, W.</p> <p>Do not install any type of automatic switchgear between the drive and the motor</p> <p>Wherever control cabling is close to power cabling, maintain a minimum separation of 4in. (100 mm) and arrange crossings at 90 degrees</p> <p>Ensure that all terminals are tightened to the appropriate torque setting</p> <p>Do not attempt to carry out any repair of the ACS255. In the case of suspected fault or malfunction, contact your local ABB Drives representative for further assistance.</p>		

### 3. General Information and Ratings

---

This chapter contains information about the ACS255 including how to identify the drive.

#### 3.1. Type designation key

The type designation contains information on the specification and configuration of the drive. You find the type designation label attached to the drive. The first digits from the left express the basic configuration, for example ACS255-03U-02A1-6. The explanations of the type designation label selections are described below.

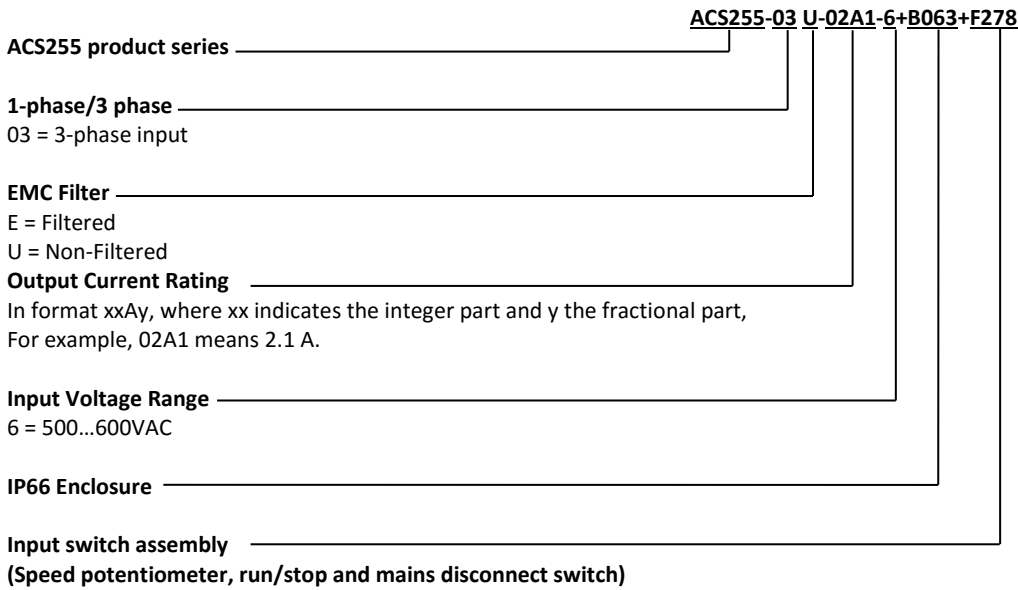

### 3.2. Drive model numbers – IP20

Mechanical Dimensions and Mounting information is shown from page 15.

Electrical Specifications are shown on page 59.

Model Number	Power (HP)	Output Current (A)	Input switch assembly	Internal DB transistor	Frame Size
ACS255-03U-02A1-6	1	2.1	No	Yes	P2
ACS255-03U-03A1-6	2	3.1	No	Yes	P2
ACS255-03U-04A1-6	3	4.1	No	Yes	P2
ACS255-03U-06A5-6	5	6.5	No	Yes	P2
ACS255-03U-09A0-6	7.5	9	No	Yes	P2
ACS255-03U-12A0-6	10	12	No	Yes	P3
ACS255-03U-17A0-6	15	17	No	Yes	P3
ACS255-03U-22A0-6	20	22	No	Yes	P3

### 3.3. Drive model numbers – IP66

Mechanical Dimensions and Mounting information is shown from page 15.

Electrical Specifications are shown on page 59.

Model Number	Power (HP)	Output Current (A)	Input switch assembly	Internal DB transistor	Frame Size
ACS255-03U-02A1-6 +B063	1	2.1	No	Yes	P2
ACS255-03U-03A1-6 +B063	2	3.1	No	Yes	P2
ACS255-03U-04A1-6 +B063	3	4.1	No	Yes	P2
ACS255-03U-06A5-6 +B063	5	6.5	No	Yes	P2
ACS255-03U-09A0-6 +B063	7.5	9	No	Yes	P2
ACS255-03U-12A0-6 +B063	10	12	No	Yes	P3
ACS255-03U-17A0-6 +B063	15	17	No	Yes	P3
ACS255-03U-02A1-6 +B063 +F278	1	2.1	Yes	Yes	P2
ACS255-03U-03A1-6 +B063 +F278	2	3.1	Yes	Yes	P2
ACS255-03U-04A1-6 +B063 +F278	3	4.1	Yes	Yes	P2
ACS255-03U-06A5-6 +B063 +F278	5	6.5	Yes	Yes	P2
ACS255-03U-09A0-6 +B063 +F278	7.5	9	Yes	Yes	P2
ACS255-03U-12A0-6 +B063 +F278	10	12	Yes	Yes	P3
ACS255-03U-17A0-6 +B063 +F278	15	17	Yes	Yes	P3

## 4. Mechanical Installation

### 4.1. General

- The ACS255 should be mounted in a vertical position only, on a flat, flame resistant, vibration free mounting using the integral mounting holes or DIN Rail clip (Size P2 only).
- The ACS255 must be installed in a pollution degree 1 or 2 environment only.
- Do not mount flammable material close to the ACS255
- Ensure that the minimum cooling air gaps, as detailed in section 4.5 and 4.7 are left clear.
- Ensure that the ambient temperature range does not exceed the permissible limits for the ACS255 are given on page 60.
- Provide suitable clean, moisture and contaminant free cooling air sufficient to fulfil the cooling requirements of the ACS255.

### 4.2. Before Installation

- Carefully Unpack the ACS255 and check for any signs of damage. Notify the shipper immediately if any exist.
- Check the drive rating label to ensure it is of the correct type and power requirements for the application.
- To prevent accidental damage always store the ACS255 in its original box until required. Storage should be clean and dry and within the temperature range  $-40^{\circ}\text{C}$  to  $+60^{\circ}\text{C}$ .

### 4.3. UL Compliant Installation

Note the following for UL-compliant installation:

- For an up to date list of UL compliant products, please refer to UL listing NMMS.E211945.
- The drive can be operated within an ambient temperature range as stated in section 11.1.
- For IP20 units, installation is required in a pollution degree 1 environment.
- For IP66 units, installation in a pollution degree 2 environment is permissible.
- UL Listed ring terminals / lugs must be used for all bus bar and grounding connections.

### 4.4. Mechanical dimensions and weights

#### 4.4.1. IP20 Units

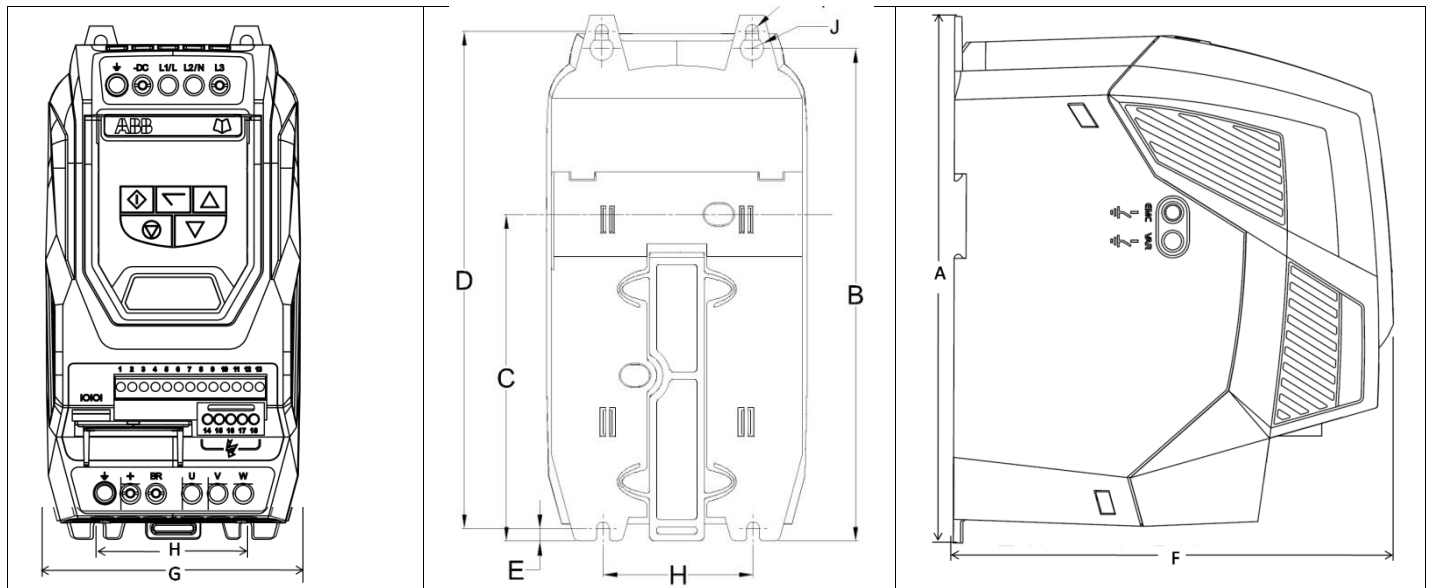

Drive Size	A		B		C		D		E		F		G		H		I		J		Weight	
	mm	in	mm	in	mm	in	mm	in	mm	in	mm	in	mm	in	mm	in	mm	in	mm	in	Kg	lb
2	221	8.70	207	8.15	137	5.39	209	8.23	5.3	0.21	185	7.28	112	4.41	63	2.48	5.5	0.22	10	0.39	1.8	4
3	261	10.28	246	9.69	-	-	247	9.72	6	0.24	205	8.07	131	5.16	80	3.15	5.5	0.22	10	0.39	3.5	7.7

#### Mounting Bolts

All Frame Sizes : 4 x M4

#### Tightening Torques

Recommended Control Terminal Torque Settings : All Sizes : 0.8 Nm (7 lb-in)

Recommended Power Terminal Torque Settings : All Sizes : 1 Nm (8.85 lb-in)

4.4.2. IP66 Units

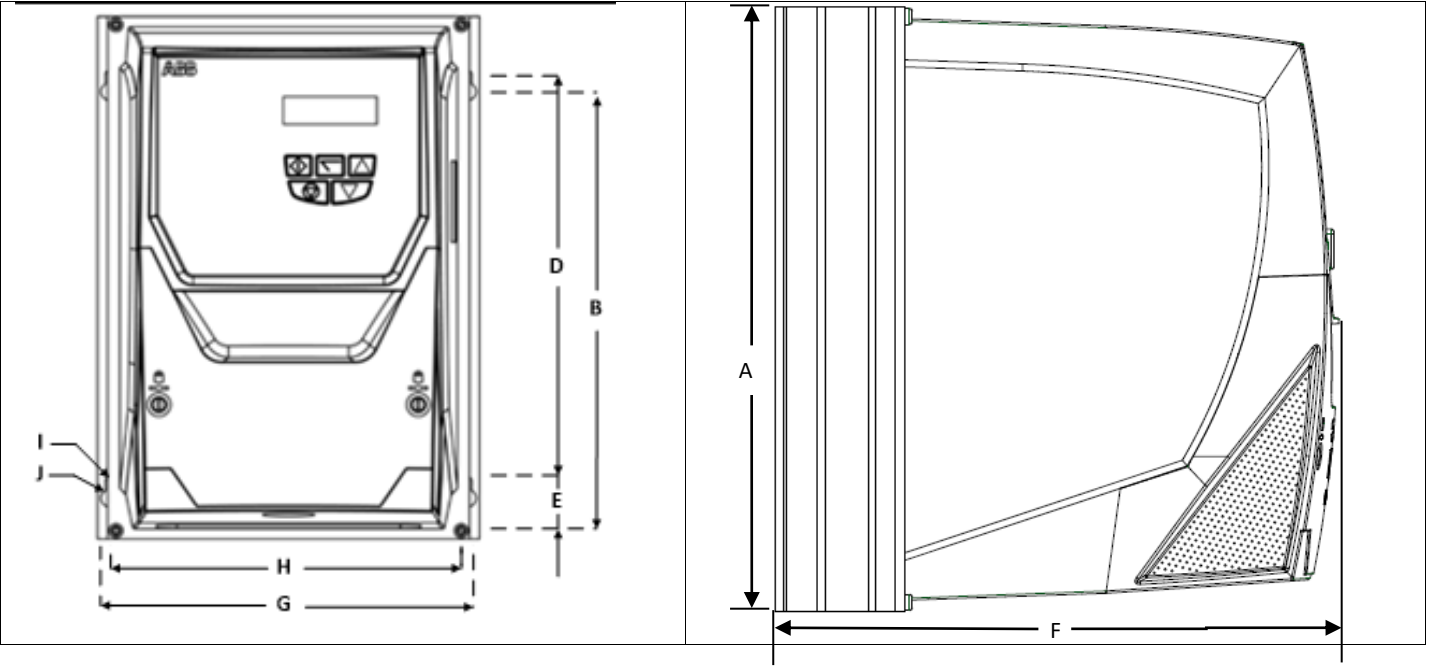

Drive Size	A		B		D		F		G		H		I		J		Weight	
	mm	in	mm	in	mm	in	mm	in	mm	in	mm	in	mm	in	mm	in	Kg	lb
2	257	10.12	220	8.66	200	7.87	239	9.41	188	7.40	176	6.93	4.2	0.17	8.5	0.33	4.8	10.6
3	310	12.20	277	10.89	252	9.90	251	9.88	211	8.29	198	7.78	4.2	0.17	8.5	0.33	7.3	16.1

Mounting Bolt Sizes

All Frame Sizes 4 x M4

Tightening Torques

Recommended Control Terminal Torque Settings :All Sizes : 0.8 Nm (7 lb-in)  
 Recommended Power Terminal Torque Settings :Frame Size 2 : 1.2 – 1.5 Nm (10 – 15 lb-in)



#### 4.5. Guidelines for Enclosure mounting (IP20 Units)

- IP20 drives must be installed in a pollution degree 2 environment, mounted in a cabinet with IP54 or better.
- Installation should be in a suitable enclosure, according to EN60529 or other relevant local codes or standards.
- Enclosures should be made from a thermally conductive material.
- Where vented enclosures are used, there should be free space clearance above and below the drive to ensure good air circulation – see the diagram below for minimum free space clearance. Air should be drawn in below the drive and expelled above the drive.
- In any environments where the conditions require it, the enclosure must be designed to protect the ACS255 against ingress of airborne dust, corrosive gases or liquids, conductive contaminants (such as condensation, carbon dust, and metallic particles) and sprays or splashing water from all directions.
- High moisture, salt or chemical content environments should use a suitably sealed (non-vented) enclosure.

The enclosure design and layout should ensure that the adequate ventilation paths and clearances are left to allow air to circulate through the drive heatsink. Recommend below is the minimum mounting clearance requirements for drives mounted in non-ventilated metallic enclosures.

Drive Frame Size	X Above & Below		Y Either Side		Z Between	
	mm	in	mm	in	mm	in
2	75	2.95	50	1.97	46	1.81
3	100	3.94	50	1.97	52	2.05
<b>Note :</b>						
Dimension Z assumes that the drives are mounted side-by-side with no clearance.						
Typical drive heat losses are 3% of operating load conditions.						
Above are guidelines only and the operating ambient temperature of the drive MUST be maintained at all times.						

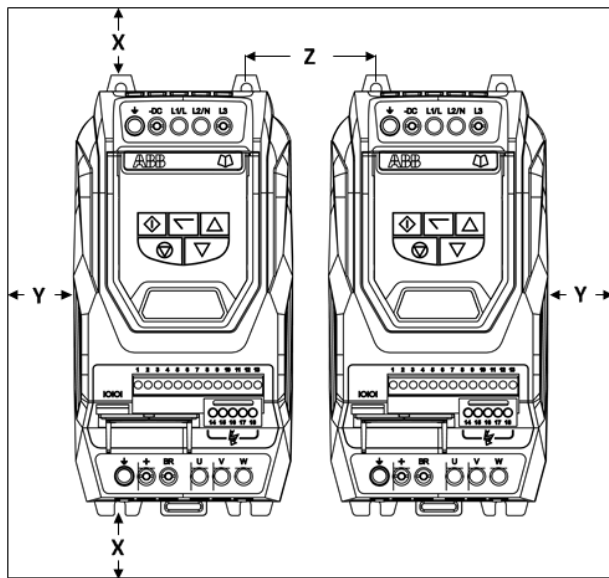

#### 4.6. Mounting the Drive – IP20 Units

- IP20 Units are intended for installation within a control cabinet.
- When mounting with screws
  - Using the drive as a template, or the dimensions shown above, mark the locations for drilling
  - Ensure that when mounting locations are drilled, the dust from drilling does not enter the drive
  - Mount the drive to the cabinet backplate using suitable M4 mounting screws
  - Position the drive, and tighten the mounting screws securely
- When Din Rail Mounting (Frame Size 2 Only)
  - Locate the DIN rail mounting slot on the rear of the drive onto the top of the DIN rail first
  - Press the bottom of the drive onto the DIN rail until the lower clip attaches to the DIN rail
  - If necessary, use a suitable flat blade screw driver to pull the DIN rail clip down to allow the drive to mount securely on the rail
  - To remove the drive from the DIN rail, use a suitable flat blade screwdriver to pull the release tab downwards, and lift the bottom of the drive away from the rail first

### 4.7. Guidelines for mounting (IP66 Units)

- Before mounting the drive, ensure that the chosen location meets the environmental condition requirements for the drive shown in section 11.1.
- The drive must be mounted vertically, on a suitable flat surface
- The minimum mounting clearances as shown in the table below must be observed
- The mounting site and chosen mountings should be sufficient to support the weight of the drives

Drive Frame Size	X Above & Below		Y Either Side	
	mm	in	mm	in
2	200	7.87	10	0.39
3	200	7.87	10	0.39

**Note :**  
 Typical drive heat losses are approximately 3% of operating load conditions.

Above are guidelines only and the operating ambient temperature of the drive **MUST** be maintained at all times.

**Cable Gland Sizes**

Drive Frame Size	Power Cable	Motor Cable	Control Cables
2	M25 (PG21)	M25 (PG21)	M20 (PG13.5)
3	M25 (PG21)	M25 (PG21)	M20 (PG13.5)

- Using the drive as a template, or the dimensions shown above, mark the locations required for drilling
- Suitable cable glands to maintain the ingress protection of the drive are required.
- Gland holes for power and motor cables are pre-moulded into the drive enclosure, recommended gland sizes are shown above, gland holes for control cables may be cut as required.

### 4.8. Removing the Terminal Cover

Frame Sizes 2 & 3	
	Using a suitable flat blade screwdriver, rotate the two retaining screws indicated until the screw slot is vertical.

### 4.9. Routine Maintenance

The drive should be included within the scheduled maintenance program so that the installation maintains a suitable operating environment, this should include:

- Ambient temperature is at or below that set out in the “Environment” section on page 59.
- Heat sink fans freely rotating and dust free.
- The Enclosure in which the drive is installed should be free from dust and condensation; furthermore ventilation fans and air filters should be checked for correct air flow.

Checks should also be made on all electrical connections, ensuring screw terminals are correctly torqued; and that power cables have no signs of heat damage.

## 5. Electrical Installation

### 5.1. Grounding the Drive

- 

This manual is intended as a guide for proper installation. ABB Drives Ltd cannot assume responsibility for the compliance or the non-compliance to any code, national, local or otherwise, for the proper installation of this drive or associated equipment. A hazard of personal injury and/or equipment damage exists if codes are ignored during installation.
- 

This ACS255 contains high voltage capacitors that take time to discharge after removal of the main supply. Before working on the drive, ensure isolation of the main supply from line inputs. Wait ten (10) minutes for the capacitors to discharge to safe voltage levels. Failure to observe this precaution could result in severe bodily injury or loss of life.
- 

Only qualified electrical personnel familiar with the construction and operation of this equipment and the hazards involved should install, adjust, operate, or service this equipment. Read and understand this manual and other applicable manuals in their entirety before proceeding. Failure to observe this precaution could result in severe bodily injury or loss of life.

#### 5.1.1. Recommended installation for EMC compliance.

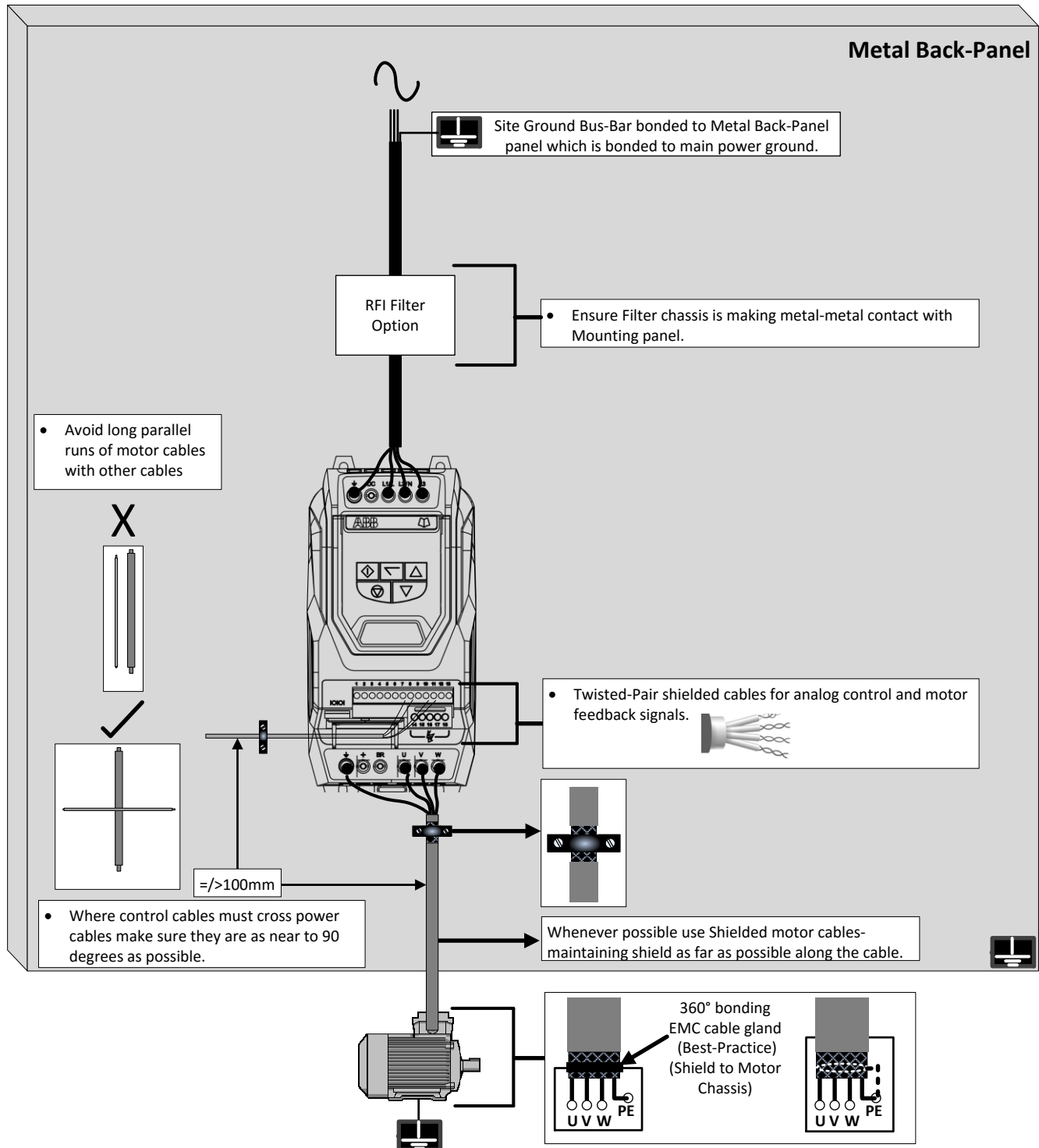

### 5.1.2. Grounding Guidelines

The ground terminal of each ACS255 should be individually connected DIRECTLY to the site ground bus bar (through the filter if installed). The ACS255 ground connections should not loop from one drive to another, or to, or from any other equipment. Ground loop impedance must confirm to local industrial safety regulations. To meet UL regulations, UL approved ring crimp terminals should be used for all ground wiring connections.

The drive Safety Ground must be connected to system ground. Ground impedance must conform to the requirements of national and local industrial safety regulations and/or electrical codes. The integrity of all ground connections should be checked periodically.

### 5.1.3. Protective Earth Conductor

The Cross sectional area of the PE Conductor must be at least equal to that of the incoming supply conductor.

### 5.1.4. Safety Ground

This is the safety ground for the drive that is required by code. One of these points must be connected to adjacent building steel (girder, joist), a floor ground rod, or bus bar. Grounding points must comply with national and local industrial safety regulations and/or electrical codes.

### 5.1.5. Motor Ground

The motor ground must be connected to one of the ground terminals on the drive.

### 5.1.6. Ground Fault Monitoring

As with all inverters, a leakage current to earth can exist. The ACS255 is designed to produce the minimum possible leakage current while complying with worldwide standards. The level of current is affected by motor cable length and type, the effective switching frequency, the earth connections used and the type of RFI filter installed. If a GFCI (Ground Fault Current Interrupter) is to be used, the following conditions apply:

- The device must be suitable for protecting equipment with a DC component in the leakage current
- Individual GFCI's should be used for each ACS255

### 5.1.7. Shield Termination (Cable Screen)

The safety ground terminal provides a grounding point for the motor cable shield. The motor cable shield connected to this terminal (drive end) should also be connected to the motor frame (motor end). Use a shield terminating or EMI clamp to connect the shield to the safety ground terminal.

## 5.2. Wiring Precautions

Connect the ACS255 according to section 5.9, ensuring that motor terminal box connections are correct. There are two connections in general: Star and Delta. It is essential to ensure that the motor is connected in accordance with the voltage at which it will be operated. For more information, refer to section 5.6 Motor Terminal Box Connections.

Type MC continuous corrugated aluminium armour cable with symmetrical grounds or shielded power cable is recommended for the motor cables if metallic conduit is not used.

The power cables must be rated for 75 °C (167 °F).

## 5.3. Incoming Power Connection

- Power should be connected to L1, L2, and L3. Phase sequence is not important.
- For compliance with CE and C Tick EMC requirements, a symmetrical shielded cable is recommended.
- For compliance with CSA requirements, transient surge suppression shall be installed on the line side of this equipment and shall be rated 600V (phase to ground), 600V (phase to phase), suitable for overvoltage category III, and shall provide protection for a rated impulse withstand voltage peak of 4 kV or equivalent.
- A fixed installation is required according to IEC61800-5-1 with a suitable disconnecting device installed between the ACS255 and the AC Power Source. The disconnecting device must conform to the local safety code / regulations (e.g. within Europe, EN60204-1, Safety of machinery).
- The cables should be dimensioned according to any local codes or regulations. Guideline dimensions are given in section 11.2.
- Suitable fuses to provide wiring protection of the input power cable should be installed in the incoming supply line, according to the data in section 11.2. The fuses must comply with any local codes or regulations in place. In general, type gG (IEC 60269) or UL type T fuses are suitable; however in some cases type aR fuses may be required. The operating time of the fuses must be below 0.5 seconds.
- When the power supply is removed from the drive, a minimum of 30 seconds should be allowed before re-applying the power. A minimum of 5 minutes should be allowed before removing the terminal covers or connection.
- The maximum permissible short circuit current at the ACS255 Power terminals as defined in IEC60439-1 is 100kA.
- An optional Input Choke is recommended to be installed in the supply line for drives where any of the following conditions occur:-
  - The incoming supply impedance is low or the fault level / short circuit current is high.
  - If the transformer kVA rating is more than 10x the kVA rating of the drive or ensure that the per drive source impedance is less than 0.5%
  - The supply is prone to dips or brown outs
  - An imbalance exists on the supply (3 phase drives)
  - The power supply to the drive is via a busbar and brush gear system (typically overhead Cranes).
- In all other installations, an input choke is recommended to ensure protection of the drive against power supply faults.

## 5.4. Compatibility with IT (ungrounded) and corner-grounded TN systems



**WARNING!** EMC filters should not be used when installing the drive on an IT system (an ungrounded power system or high-resistance-grounded power system, otherwise the system will be connected to ground potential through the EMC capacitors. This may cause danger or damage to the EMC filter.

If you have an IT (ungrounded) system or corner-grounded TN system, disconnect the internal Varistor screw as shown below.

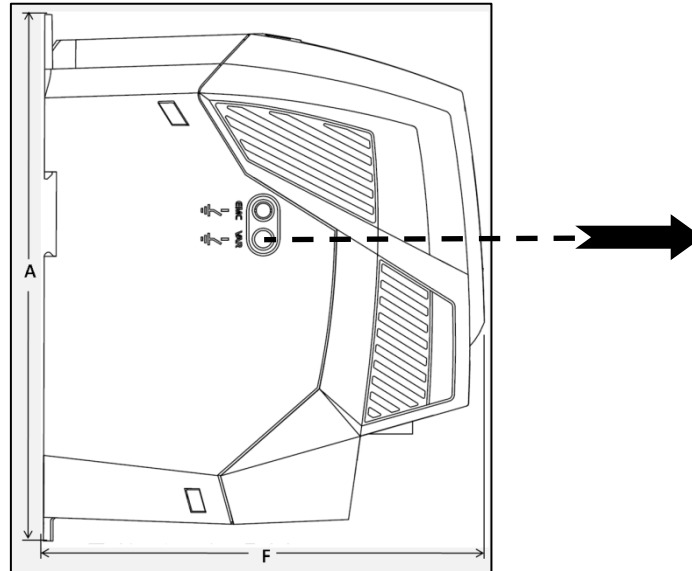

### 5.5. Drive and Motor Connection

- The drive inherently produces fast switching of the output voltage (PWM) to the motor compared to the mains supply, for motors which have been wound for operation with a variable speed drive then there is no preventative measures required, however if the quality of insulation is unknown then the motor manufacturer should be consulted and preventative measures may be required.
- The motor should be connected to the ACS255 U, V, and W terminals using a suitable 3 or 4 core cable. Where a 3 core cable is utilised, with the shield operating as an earth conductor, the shield must have a cross sectional area at least equal to the phase conductors when they are made from the same material. Where a 4 core cable is utilised, the earth conductor must be of at least equal cross sectional area and manufactured from the same material as the phase conductors.
- The motor earth must be connected to one of the ACS255 earth terminals.
- For compliance with the European EMC directive, a suitable screened (shielded) cable should be used. Braided or twisted type screened cable where the screen covers at least 85% of the cable surface area, designed with low impedance to HF signals are recommended as a minimum. Installation within a suitable steel or copper tube is generally also acceptable.
- The cable screen should be terminated at the motor end using an EMC type gland allowing connection to the motor body through the largest possible surface area
- Where drives are mounted in a steel control panel enclosure, the cable screen may be terminated directly to the control panel using a suitable EMC clamp or gland, as close to the drive as possible.
- For IP66 drives, connect the motor cable screen to the internal ground clamp

### 5.6. Motor Terminal Box Connections

Most general purpose motors are wound for operation on dual voltage supplies. This is indicated on the nameplate of the motor

This operational voltage is normally selected when installing the motor by selecting either STAR or DELTA connection. STAR always gives the higher of the two voltage ratings. . Example Motor nameplate shown below (380V Delta illustrated):

ABB Motors									
3 ~ motor M2AA 200 MLA 4									
IEC 200 M/L 55									
No									
Ins.cl. F IP 55									
V	Hz	kW	r/min	A	cos φ	IA/IN	η	E/s	
690 Y	50	30	1475	32.5	0.83				
400 D	50	30	1475	56	0.83				
660 Y	50	30	1470	34	0.83				
380 D	50	30	1470	59	0.83				380 V Mains Voltage
415 D	50	30	1475	54	0.83				
440 D	60	35	1770	59	0.83				
Cat. no 3GAA 202 001 - ADA									
6312/C3		6210/C3		180 kg					
IEC 34-1									

### 5.7. Motor Thermal overload Protection.

#### 5.7.1. Internal Thermal overload protection.

The drive has an in-built motor thermal overload function; this is in the form of an “F0009” trip after delivering >100% of the value set in parameter **9906** MOTOR RATED CURRENT for a sustained period of time (e.g. 150% for 60 seconds).

#### 5.7.2. Motor Thermistor Connection

Where a motor thermistor is to be used, it should be connected as follows :-

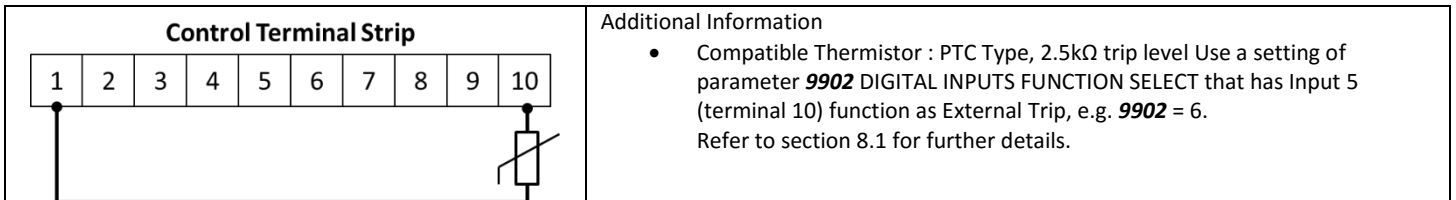

### 5.8. Control Terminal Wiring

- All analog signal cables should be suitably shielded. Twisted pair cables are recommended.
- Power and Control Signal cables should be routed separately where possible, and must not be routed parallel to each other.
- Signal levels of different voltages e.g. 24 Volt DC and 600 Volt AC, should not be routed in the same cable.
- Maximum control terminal tightening torque is 0.5Nm.
- Control Cable entry conductor size: 0.05 – 2.5mm<sup>2</sup> / 30 – 12 AWG.

## 5.9. Connection Diagram

### 5.9.1. Power Terminal Designations

**Incoming Power Source**  
Connect to L1, L2 & L3 terminals.  
Phase sequence is not important.

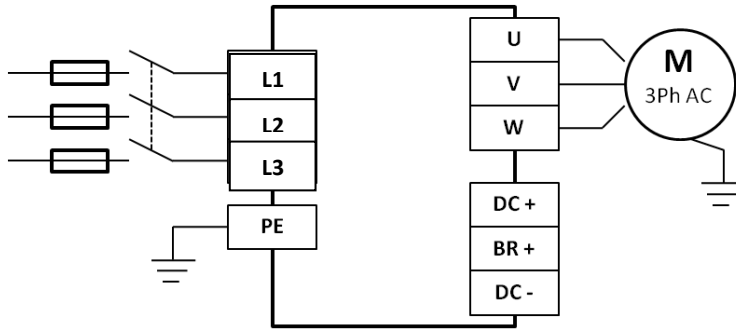

**Motor Connections**  
Connect the motor to the U, V & W terminals.  
The motor earth must be connected to the drive

**Optional Brake Resistor & DC Bus Connections**  
Where a Brake resistor is used, it must be connected to the "BR" and "+" terminals.

 The brake resistor should be protected from overheating by means of a thermal switch which interrupts the mains supply in a brake resistor fault situation.

### 5.9.2. Control Terminal Connections & Factory Settings

	Open	Closed						
<b>+24V Supply (100mA) / External Input</b>				+24V	1			
<b>Digital Input 1</b>	Stop	Run (Enable)		DI1	2			
<b>Digital Input 2</b>	Forward Rotation	Reverse Rotation		DI2	3			
<b>Digital Input 3</b>	Analog Speed Ref	Preset Speed		DI3	4			
Digital Inputs : 8 – 30 Volt DC + 10 Volt, 10mA Output				+10V	5			
<b>Analog Input 1</b>				DI/AI4	6			
				0V	7	0V		
					8	AO1		Output Speed
Analog Output : 0 – 10 Volt / 4-20mA, 20mA Max					9	0V		
<b>0 Volt Supply / External Input</b>				0V	9	0V		
<b>Analog Input 2</b>				DI/AI5	10			
Analog Output : 0 – 10 Volt / 4-20mA, 20mA Max					11	AO2		Output Current
<b>SAFE TORQUE OFF Input</b> Also refer to page 24 for further information on the STO Function. Logic High = 18-30 Volt DC ("SAFE TORQUE OFF" Standby mode)				STO+	12			
				STO-	13			
Relay Contacts (Terminals 14-18) 250VAC / 30VDC 5A Maximum					14	R01COM		Default Function : Drive Ready / Fault
					15	R01NO		
						16	R01NC	
						17	R02NO	
					18	R02COM		

## 5.10. Safe Torque Off

Safe Torque OFF will be referred to as “STO” through the remainder of this section.

### 5.10.1. Responsibilities

The overall system designer is responsible for defining the requirements of the overall “Safety Control System” within which the drive will be incorporated; furthermore the system designer is responsible for ensuring that the complete system is risk assessed and that the “Safety control System” requirements have been entirely met and that the function is fully verified, this must include confirmation testing of the “STO” function before drive commissioning.

The system designer shall determine the possible risks and hazards within the system by carrying out a thorough risk and hazard analysis, the outcome of the analysis should provide an estimate of the possible hazards, furthermore determine the risk levels and identify any needs for risk reduction. The “STO” function should be evaluated to ensure it can sufficiently meet the risk level required.

### 5.10.2. What STO Provides

The purpose of the “STO” function is to provide a method of preventing the drive from creating torque in the motor in the absence of the “STO” input signals (Terminal 12 with respect to Terminal 13), this allows the drive to be incorporated into a complete safety control system where “STO” requirements need to be fulfilled.<sup>1</sup>

The “STO” function can typically eliminate the need for electro-mechanical contactors with cross-checking auxiliary contacts as per normally required to provide safety functions.<sup>2</sup>

The drive has the “STO” Function built-in as standard and complies with the definition of “Safe torque off” as defined by IEC 61800-5-2:2007.

The “STO” Function also corresponds to an uncontrolled stop in accordance with category 0 (Emergency Off), of IEC 60204-1. This means that the motor will coast to a stop when the “STO” function is activated, this method of stopping should be confirmed as being acceptable to the system the motor is driving.

The “STO” function is recognised as a fail safe method even in the case where the “STO” signal is absent and a single fault within the drive has occurred, the drive has been proven in respect of this by meeting the following safety standards :

	SIL (Safety Integrity Level)	PFH <sub>D</sub> (Probability of dangerous Failures per Hour)	SFF (Safe failure fraction %)	Lifetime assumed
EN 61800-5-2	2	1.23E-09 1/h (0.12 % of SIL 2)	50	20 Yrs

	PL (Performance level)	CCF (%) (Common Cause Failure)
EN ISO 13849-1	PL d	1

	SILCL
EN 62061	SILCL 2

Note : The values achieved above maybe jeopardised if the drive is installed outside of the Environmental limits detailed in section 11.1 on page 59.

### 5.10.3. What STO does not provide



Disconnect and ISOLATE the drive before attempting any work on it. The “STO” function does not prevent high voltages from being present at the drive power terminals.



<sup>1</sup> Note : The “STO” function does not prevent the drive from an unexpected re-start. As soon as the “STO” inputs receive the relevant signal it is possible (subject to parameter settings) to restart automatically, Based on this, the function should not be used for carrying out short-term non-electrical machinery operations (such as cleaning or maintenance work).



<sup>2</sup> Note : In some applications additional measures may be required to fulfil the systems safety function needs : the “STO” function does not provide motor braking. In the case where motor braking is required a time delay safety relay and/or a mechanical brake arrangement or similar method should be adopted, consideration should be made over the required safety function when braking as the drive braking circuit alone cannot be relied upon as a fail safe method.



#### 5.10.4. "STO" Operation

When the "STO" inputs are energised, the "STO" function is in a standby state, if the drive is then given a "Start signal/command" (as per the start source method selected in parameter **9902** DIGITAL INPUTS FUNCTION SELECT) then the drive will start and operate normally.

When the "STO" inputs are de-energised then the STO Function is activated and stops the drive (Motor will coast), the drive is now in "Safe Torque Off" mode.

To get the drive out of "Safe Torque Off" mode then any "Fault messages" need to be reset and the drive "STO" input needs to be re-energised.

#### 5.10.5. "STO" Status and Monitoring

There are a number of methods for monitoring the status of the "STO" input, these are detailed below:

##### Drive Display

In Normal drive operation (Mains AC power applied), when the drives "STO" input is de-energised ("STO" Function activated) the drive will highlight this by displaying "InHibit", (Note: If the drive is in a tripped condition then the relevant trip will be displayed and not "InHibit").

##### Drive Output Relay

- Drive relay 1: Setting parameter **1401** USER RELAY 1 OUTPUT (TERMINALS 14, 15 & 16) FUNCTION SELECT to a value of "13" will result in relay opening when the "STO" function is activated.
- Drive relay 2: Setting parameter **1402** USER RELAY 2 OUTPUT (TERMINALS 17 & 18) FUNCTION SELECT to a value of "13" will result in relay opening when the "STO" function is activated.

##### "STO" Fault Codes

Fault Code	Code Number	Description	Corrective Action
"Sto-F"	29	A fault has been detected within either of the internal channels of the "STO" circuit.	Refer to local ABB representative

#### 5.10.6. "STO" Function response time

The total response time is the time from a safety related event occurring to the components (sum of) within the system responding and becoming safe. (Stop Category 0 in accordance with IEC 60204-1)

- The response time from the "STO" inputs being de-energised to the output of the drive being in a state that will not produce torque in the motor ("STO" active) is less than 1ms.
- The response time from the "STO" inputs being de-energised to the "STO" monitoring status changing state is less than 20ms
- The response time from the drive sensing a fault in the STO circuit to the drive displaying the fault on the display/Digital output showing drive not healthy is less than 20ms.

**5.10.7. “STO” Electrical Installation**



The “STO” wiring shall be protected from inadvertent short circuits or tampering which could lead to failure of the “STO” input signal, further guidance is given in the diagrams below.

In addition to the wiring guidelines for the “STO” circuit below, section 5.1.1 “Recommended installation for EMC compliance should also be followed.

The drive should be wired as illustrated below; the 24Vdc signal source applied to the “STO” input can be either from the 24Vdc on the drive or from an External 24Vdc power supply.

**5.10.7.1. Recommended “STO” wiring**

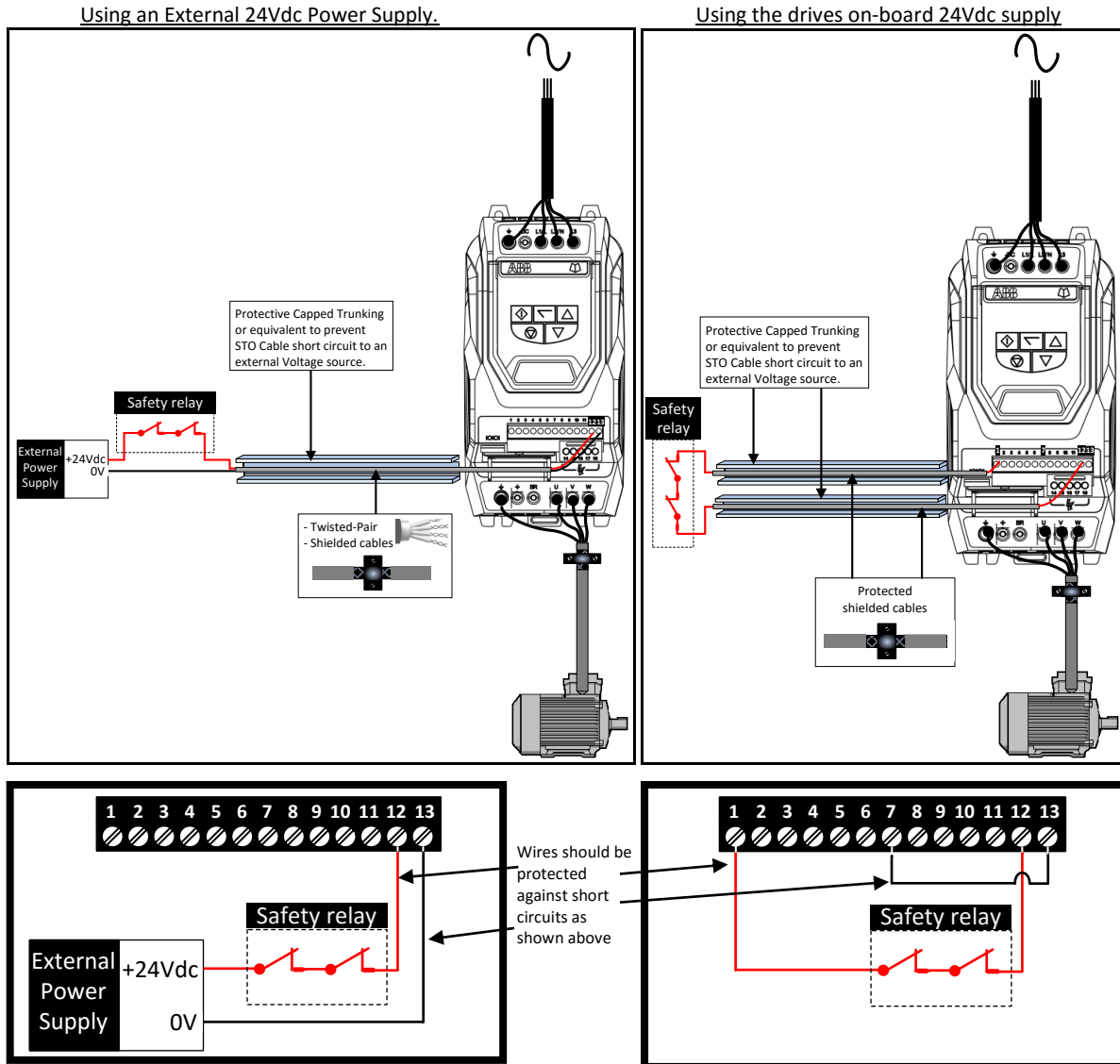

**Note :** The Maximum cable length from Voltage source to the drive terminals should not exceed 25 metres.

**5.10.7.2. External Power supply Specification.**

<b>Voltage Rating (Nominal)</b>	24Vdc
<b>STO Logic High</b>	18-30Vdc (Safe torque off in standby)
<b>Current Consumption (Maximum)</b>	100mA

**5.10.7.3. Safety Relay Specification.**

The safety relay should be chosen so that at minimum it meets the safety standards in which the drive meets.

<b>Standard Requirements</b>	SIL2 or PLd SC3 or better (With Forcibly guided Contacts)
<b>Number of Output Contacts</b>	2 independent
<b>Switching Voltage Rating</b>	30Vdc
<b>Switching Current</b>	100mA

### 5.10.8. Enabling the “STO” Function

The “STO” function is always enabled in the drive regardless of operating mode or parameter changes made by the user.

### 5.10.9. Testing the “STO” Function

Before commissioning the system the “STO” function should always be tested for correct operation, this should include the following tests:

- With the motor at standstill, and a stop command given to the drive (*as per the start source method selected in parameter 9902 DIGITAL INPUTS FUNCTION SELECT*):
  - De-energise the “STO” inputs (Drive will display “InHibit”).
  - Give a start command (*as per the start source method selected in parameter 9902 DIGITAL INPUTS FUNCTION SELECT*) and check that the drive still displays “Inhibit” and that the operation is in line with the section 5.10.4 “STO” Operation and section 5.10.5 “STO” Status and Monitoring
- With the motor running normally (from the drive):
  - De-energise the “STO” inputs
  - Check that the drive displays “InHibit” and that the motor stops and that the operation is in line with the section 5.10.4 “STO” Operation and section 5.10.5 “STO” Status and Monitoring

### 5.10.10. “STO” Function Maintenance.

The “STO” function should be included within the control systems scheduled maintenance program so that the function is regularly tested for integrity (Minimum once per Year), furthermore the function should be integrity tested following any safety system modifications or maintenance work.

If drive fault messages are observed refer to section 13.1 for further guidance.

## 6. Managing the Keypad

The drive is configured and its operation monitored via the keypad and display.



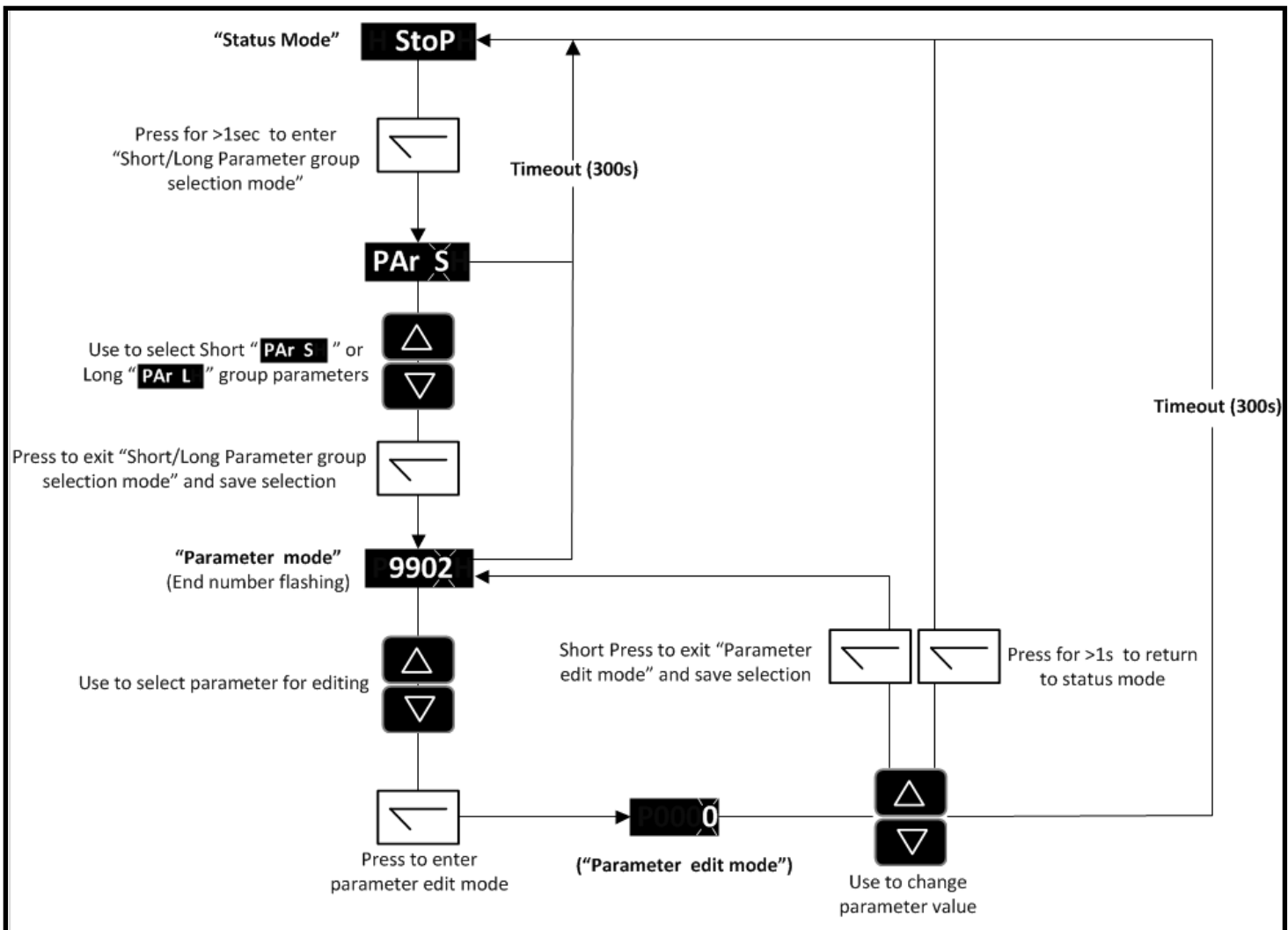

### 6.1. Keypad Layout and Function

	NAVIGATE	Used to display real-time information, to access and exit parameter edit mode and to store parameter changes (press for >1 second to toggle between status and parameter mode)	
	UP	Used to increase speed in real-time mode or to increase parameter values in parameter edit mode	
	DOWN	Used to decrease speed in real-time mode or to decrease parameter values in parameter edit mode	
	RESET / STOP	Used to reset a tripped drive. When in Keypad mode is used to Stop a running drive.	
	START	When in keypad mode, used to Start a stopped drive or to reverse the direction of rotation if bi-directional keypad mode is enabled.	

















### 6.2. Changing Parameters



### 6.3. Resetting Parameters to Factory Default Settings

 <p>The control panel features a red LED display showing the word "STOP". Below the display are five buttons: a diamond-shaped button, a left-pointing arrow, an upward-pointing triangle, a downward-pointing triangle, and a semi-circular button with a downward-pointing triangle.</p>	<p>Press and hold the</p>  <p>Keys for at least 2 seconds</p> <p>The display will show</p> <p><i>P-dEF</i></p> <p>Press the  key</p>	 <p>The control panel features a red LED display showing "P-dEF". The button layout is identical to the first panel.</p>
---	--	---

### 6.4. Advanced Keypad Operation ShortCuts

Function	When Display shows...	Press...	Result	Example
Select lowest Parameter within Group	i.e. <b>9905</b>	 + 	The first parameter of the group is selected	Display shows <b>9905</b> Press   Display shows <b>9902</b>
Set Parameter to minimum value	Any numerical value (Whilst editing a parameter value)	 + 	The parameter is set to the minimum value	When editing <b>9905</b> Display shows <b>230</b> Press   Display shows <b>20</b>
Adjusting individual digits within a parameter value	Any numerical value (Whilst editing a parameter value)	 + 	Individual parameter digits can be adjusted	When editing <b>1301</b> Display shows <b>0</b> Press   Display shows <b>0.1</b> Press  Display shows <b>1.1</b> Press   Display shows <b>-1.1</b> Press  Display shows <b>11.1</b>

### 6.5. Drive Operating Displays





Display	Status	
<b>StoP</b>	Drive mains power applied, but no Enable or Run signal applied	
<b>Autot</b>	Motor Autotune in progress.	
<b>H x.x</b>	Drive running, display shows output frequency (Hz)	Whilst the drive is running, the following displays can be selected by briefly pressing the  button on the drive. Each press of the button will cycle the display through to the next selection.
<b>I x.x</b>	Drive running, display shows motor current (Amps)	
<b>P x.x</b>	Drive Running, display shows motor power (kW)	
<b>C x.x</b>	Drive Running, display shows customer selected units, see parameters <b>3400</b> DISPLAY SCALING FACTOR and <b>3405</b> DISPLAY SCALING SOURCE	
<b>EtL-24</b>	Drive mains power not present, external 24 Volt control power supply present only	
<b>INHIB</b>	Output power hardware inhibited, hardware enable circuit open. External links are required to the STO inputs (terminals 12 and 13) as shown on page 23.	
<b>P-DEF</b>	Parameters reset to factory default settings	
<b>For drive fault code displays, refer to section 13.1 on page 62</b>		

## 7. Quick Start-up and Control

### 7.1. Quick Start-up Terminal Control

When delivered, the ACS255 is in the factory default state, meaning that it is set to operate in terminal control mode and all parameters have the default values as indicated in section 9.







- Perform mechanical and electrical installations per section 4 and 5.
- Connect the motor to the drive, ensuring the correct star/delta connection for the voltage rating - see section 5.6 on page 22.
- Apply the mains power to the drive, then enter the motor data from motor nameplate; **9905** = motor rated voltage, **9906** = motor rated current, **9907** = motor rated frequency, & **9908** = motor rated speed.
- Connect the Drive Hardware Enable (STO) circuit as follows (see section 5.10.7 "STO" Electrical Installation for further details)
  - Link Terminal 1 to Terminals 12 (STO +)
  - Link Terminal 9 to Terminal 13 (STO -)









**Note : If the "STO" function is being utilised as part of an overall safety system then the circuit should be installed and integrity tested as per the guidance given in section 5.10 "Safe Torque Off".**
- Connect a control switch between the control terminals 1 and 2 ensuring that the contact is open (drive disabled).
- Connect a potentiometer (1kΩ min to 10kΩ max) between terminals 5 and 7, and the wiper to terminal 6.
- With the potentiometer set to zero, switch on the supply to the drive. The display will show **StoP**.
- Close the control switch, terminals 1-2. The drive is now 'enabled' and the output frequency/speed are controlled by the potentiometer. The display shows zero speed in Hz (**H 0.0**) with the potentiometer turned to minimum.
- Turn the potentiometer to maximum. The motor will accelerate to 60Hz, the default value of parameter **2008**, under the control of the acceleration ramp time parameter **2202**.
- If the potentiometer is turned to minimum, the motor will decelerate to 0Hz, the default minimum speed set in parameter **2007**, under the control of the deceleration ramp parameter **2203**. The output speed can be adjusted anywhere between minimum and maximum speed using the potentiometer.
- To display motor current (Amps), briefly press the  (Navigate) key.
- Press  again to display the motor power.
- Press  again to display the estimated motor speed (RPM). (Motor nameplate RPM must be entered in **9908** = motor rated speed)
- Press  again to return to speed (Hz) display.
- To stop the motor, disable the drive by opening the control switch (terminals 1-2).
- If the enable/disable switch is opened the drive will decelerate to stop at which time the display will show **StoP**. If the potentiometer is turned to zero with the enable/disable closed the display will show **H 0.0** (0.0Hz), if left like this for 20 seconds the drive will go into standby mode, display shows **Stndby**, waiting for a speed reference signal.

### 7.2. Quick Start-up Keypad Control

To allow the ACS255 to be controlled from the keypad in a forward direction only, set parameter **1103** PRIMARY COMMAND SOURCE MODE to 1:

- Connect the drive to the supply, ensuring the correct voltage and fusing protection – see section 11.2 on page 59.
- Connect the motor to the drive, ensuring the correct star/delta connection for the voltage rating - see section 5.6 on page 22.
- Apply the mains power to the drive, then enter the motor data from motor nameplate; **9905** = motor rated voltage, **9906** = motor rated current, **9907** = motor rated frequency.
- Connect the Drive Hardware Enable (STO) circuit as follows (see section 5.10.7 "STO" Electrical Installation for further details)
  - Link Terminal 1 to Terminals 12 (STO +)
  - Link Terminal 9 to Terminal 13 (STO -)

**Note : If the "STO" function is being utilised as part of an overall safety system then the circuit should be installed and integrity tested as per the guidance given in section 5.10 "Safe Torque Off".**
- Connect a control switch between the control terminals 1 and 2 ensuring that the contact is open (drive disabled).
- Enable the drive by closing the switch between control terminals 1 & 2. The display will show **StoP**.
- Press the  key. The display shows **H 0.0**.
- Press  to increase speed.
- The drive will run forward, increasing speed until  is released.
- Press  to decrease speed. The drive will decrease speed until  is released. The rate of deceleration is limited by the setting in parameter **2203**.
- Press the  key. The drive will decelerate to rest at the rate set in parameter **2203**.
- The display will finally show **StoP** at which point the drive is disabled

- To preset a target speed prior to enable, press the  key whilst the drive is stopped. The display will show the target speed, use the  &  keys to adjust as required then press the  key to return the display to **Stop**.
- Pressing the  key will start the drive accelerating to the target speed.
- To allow the ACS255 to be controlled from the keypad in a forward and reverse direction, set parameter **1103** = 2:
- Operation is the same as when parameter **1103**=1 for start, stop and changing speed.
- Press the  key. The display changes to **H 0.0**.
- Press  to increase speed
- The drive will run forward, increasing speed until  is released. Acceleration is limited by the setting in parameter **2202**. The maximum speed is the speed set in parameter **2008**.
- To reverse the direction of rotation of the motor, press the  key again.

### 7.3. Sensorless Vector Speed Control Mode

ACS255 can be programmed by the user to operate in Sensorless Vector mode, which provides enhanced low speed torque, optimum motor speed regulation regardless of load and accurate control of the motor torque. In most applications, the default Voltage Vector control mode will provide adequate performance, however if Sensorless Vector operation is required, use the following procedure.

- Enter the motor nameplate details into the relevant parameters as follows
  - **9905** MOTOR RATED VOLTAGE
  - **9906** MOTOR RATED CURRENT
  - **9907** MOTOR RATED FREQUENCY
  - (Optional) **9908** MOTOR RATED SPEED (Rpm)
  - **9915** Motor Power Factor Cos  $\phi$
- Select Sensorless Vector control mode by setting parameter **9903** MOTOR CONTROL MODE = 0
- Ensure that the motor is correctly connected to the drive
- Carry out a motor data Autotune by setting parameter **9910** MOTOR PARAMETER AUTO-TUNE ENABLE = 1



The Autotune will begin immediately when parameter **9910** MOTOR PARAMETER AUTO-TUNE ENABLE = 1 is set regardless of the status of the drive enable signal. Whilst the autotune procedure does not drive or spin the motor, the motor shaft may still turn slightly. It is not normally necessary to uncouple the load from the motor; however the user should ensure that no risk arises from the possible movement of the motor shaft.

It is essential that the correct motor data is entered into the relevant drive parameters. Incorrect parameter settings can result in poor or even dangerous performance.



## 8. Application Macros

### 8.1. Overview of macros

Application macros are pre-programmed parameter sets. While starting up the drive, the user selects the macro best suited for the purpose with parameter **9902** DIGITAL INPUTS FUNCTION SELECT and **1103** PRIMARY COMMAND SOURCE MODE.

The term “Selected Speed Reference” in the table below is determined by the value set in **1103** PRIMARY COMMAND SOURCE MODE.

1103 (control Mode)	Selected Speed Reference
0 : Terminal Mode	Analog input 1
1 : Keypad Mode (uni-directional)	Digital Potentiometer
2 : Keypad Mode (bi-directional)	Digital Potentiometer
3 : User PI mode	PI controller output
4 : Fieldbus Control	Speed reference via Fieldbus
5 : CANopen	Speed reference via CANopen

9902	Digital Input 1 (Terminal 2)	Digital Input 2 (Terminal 3)	Digital Input 3 (Terminal 4)	Analog Input 1 (Terminal 6)	Analog Input 2 (Terminal 10)	
1	O: Stop C: Run	O: Forward C: Reverse	O: Selected Speed Ref C: Preset speed 1, 2	Analog 1 Speed reference	O: Preset speed 1 C: Preset speed 2	
2	O: Stop C: Run	O: Forward C: Reverse	Digital input 3	Analog input 1	Analog input 2	Preset Speed
			Off	Off	Off	Preset Speed 1
			On	Off	Off	Preset Speed 2
			Off	On	Off	Preset Speed 3
On	On	Off	Preset Speed 4			
3	O: Stop C: Run	O: Forward C: Reverse	O: Selected Speed Ref C: Preset speed 1	Analog 1 Speed reference	Analog torque reference	
4	O: Stop C: Run	O: Forward C: Reverse	O: Selected Speed Ref C: Preset speed 1	Analog 1 Speed reference	O: Decel ramp 1 (Par <b>2203</b> ) C: Decel ramp 2 (Par <b>2206</b> ) <sup>1)</sup>	
5	O: Stop C: Run	O: Forward C: Reverse	O: Selected Speed Ref C: Analog input 2	Analog 1 Speed reference	Analog 2 Speed reference	
6	O: Stop C: Run	O: Forward C: Reverse	O: Selected Speed Ref C: Preset speed 1	Analog 1 Speed reference	<b>External trip</b> <sup>2)</sup> O: trip C: Run	
7	O: Stop C: Run	O: Forward C: Reverse	Digital input 3	Analog input 1	Preset Speed	<b>External trip</b> <sup>2)</sup> O: trip C: Run
			Off	Off	Preset Speed 1	
			On	Off	Preset Speed 2	
			Off	On	Preset Speed 3	
On	On	Preset Speed 4				
8	O: Stop C: Run	O: Forward C: Reverse	Digital input 3	Analog input 1	Preset Speed	O: Decel ramp 1 (Par <b>2203</b> ) C: Decel ramp 2 (Par <b>2206</b> ) <sup>1)</sup>
			Off	Off	Preset Speed 1	
			On	Off	Preset Speed 2	
			Off	On	Preset Speed 3	
On	On	Preset Speed 4				
9	O: Stop C: Run	O: Forward C: Reverse	Digital input 3	Analog input 1	Preset Speed	O: Selected Speed Ref C: Preset speed 1 .. 4
			Off	Off	Preset Speed 1	
			On	Off	Preset Speed 2	
			Off	On	Preset Speed 3	
On	On	Preset Speed 4				
10	O: Stop C: Run	O: Forward C: Reverse	Normally Open (N.O.) Close to increase speed	Normally Open (N.O.) Close to reduce speed	O: Selected Speed Ref C: Preset speed 1	
11	O: Stop C: Run Fwd	O: Stop C: Run Rev	O: Selected Speed Ref C: Preset speed 1, 2	Analog 1 Speed reference	O: Preset speed 1 C: Preset speed 2	
12	O: Stop C: Run Fwd	O: Stop C: Run Rev	Digital input 3	Analog input 1	Analog input 2	Preset Speed
			Off	Off	Off	Preset Speed 1
			On	Off	Off	Preset Speed 2
			Off	On	Off	Preset Speed 3
On	On	Off	Preset Speed 4			
13	O: Stop C: Run Fwd	O: Stop C: Run Rev	O: Selected Speed Ref C: Preset speed 1	Analog 1 Speed reference	Analog torque reference	
14	O: Stop C: Run Fwd	O: Stop C: Run Rev	O: Selected Speed Ref C: Preset speed 1	Analog 1 Speed reference	O: Decel ramp 1 (Par <b>2203</b> ) C: Decel ramp 2 (Par <b>2206</b> ) <sup>1)</sup>	
15	O: Stop C: Run Fwd	O: Stop C: Run Rev	O: Selected Speed Ref C: Analog input 2	Analog 1 Speed reference	Analog 2 Speed reference	
16	O: Stop C: Run Fwd	O: Stop C: Run Rev	O: Selected Speed Ref C: Preset speed 1	Analog 1 Speed reference	<b>External trip</b> <sup>2)</sup> O: trip C: Run	
17	O: Stop C: Run Fwd	O: Stop C: Run Rev	Digital input 3	Analog input 1	Preset Speed	<b>External trip</b> <sup>2)</sup> O: trip C: Run
			Off	Off	Preset Speed 1	
			On	Off	Preset Speed 2	
			Off	On	Preset Speed 3	
On	On	Preset Speed 4				
18	O: Stop C: Run Fwd	O: Stop C: Run Rev	Digital input 3	Analog input 1	Preset Speed	O: Decel ramp 1 (Par <b>2203</b> ) C: Decel ramp 2 (Par <b>2206</b> ) <sup>1)</sup>
			Off	Off	Preset Speed 1	
			On	Off	Preset Speed 2	
			Off	On	Preset Speed 3	
On	On	Preset Speed 4				

9902	Digital Input 1 (Terminal 2)	Digital Input 2 (Terminal 3)	Digital Input 3 (Terminal 4)	Analog Input 1 (Terminal 6)	Analog Input 2 (Terminal 10)	
19	O: Stop C: Run Fwd	O: Stop C: Run Rev	Digital input 3	Analog input 1	Preset Speed	O: Selected Speed Ref C: Preset speed 1 .. 4
			Off	Off	Preset Speed 1	
			On	Off	Preset Speed 2	
			Off	On	Preset Speed 3	
			On	On	Preset Speed 4	
20	O: Stop C: Run Fwd	O: Stop C: Run Rev	Normally Open (N.O.) Close to increase speed	Normally Open (N.O.) Close to reduce speed	O: Selected Speed Ref C: Preset speed 1	
21	Normally Open (N.O.) Close to run Fwd	Normally Closed (N.C.) Open to Stop	Normally Open (N.O.) Close to run Rev	Analog 1 Speed reference	O: Selected Speed Ref C: Preset speed 1	

**Note**

- 1) The drive will immediately ramp at the rate set in parameter **2206** 2nd DECELERATION RAMP TIME.
- 2) If a motor thermistor (PTC type only, or normally closed thermal switch contact) is to be connected, this must be selected in parameter **1304**. Connect the thermistor between terminal 1 and terminal 10.

**8.2. Macro wiring configurations.**

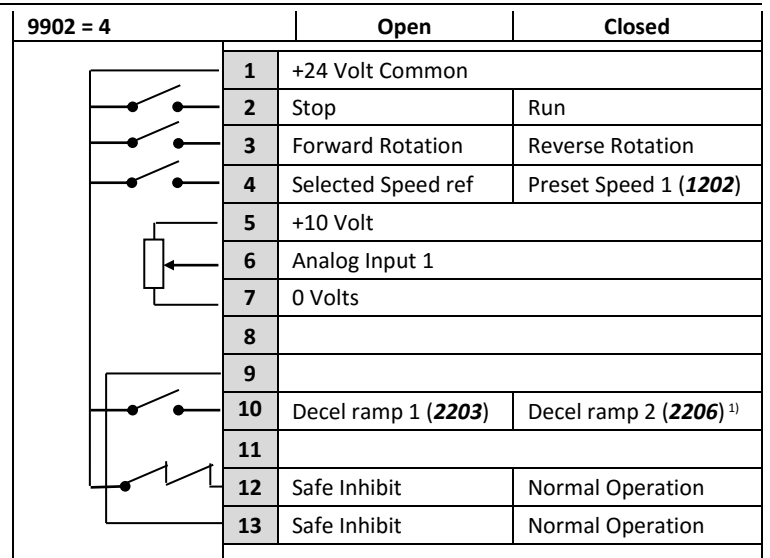
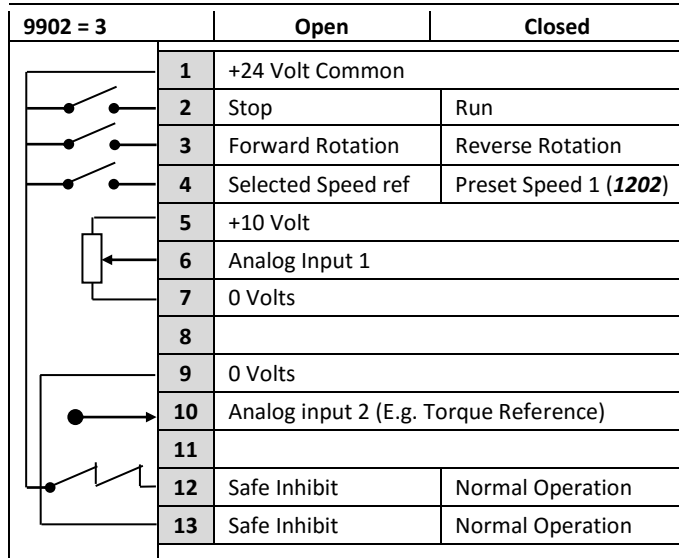
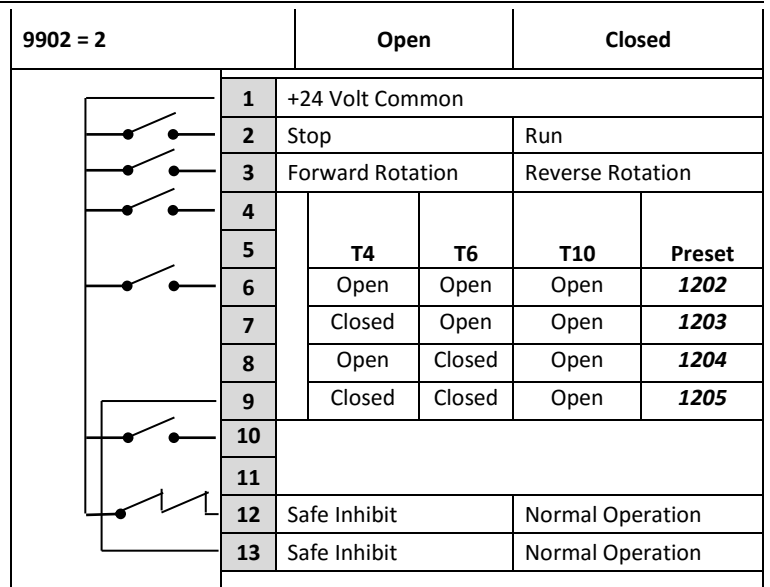
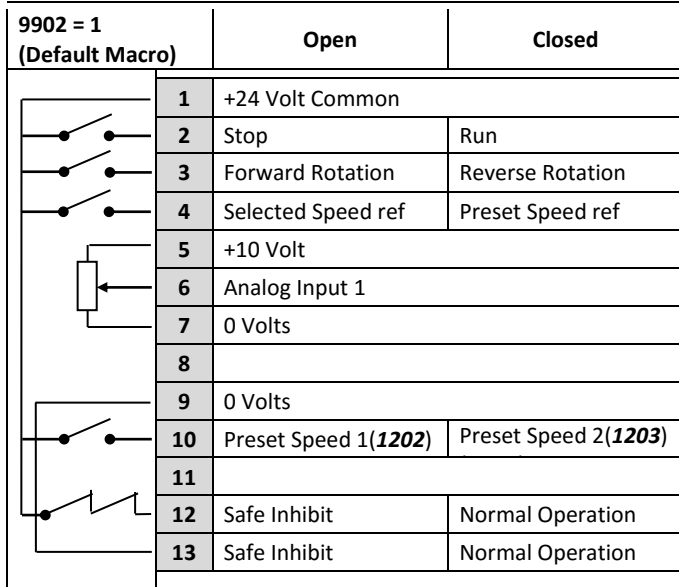

**Note**

- 1) The drive will immediately ramp at the rate set in parameter **2206** 2nd DECELERATION RAMP TIME.

9902 = 5	Open	Closed
1	+24 Volt Common	
2	Stop	Run
3	Forward Rotation	Reverse Rotation
4	Selected Speed ref	Analog input 2 speed ref
5	+10 Volt	
6	Analog Input 1	
7	0 Volts	
8		
9	0 Volts	
10	Analog input 2	
11		
12	Safe Inhibit	Normal Operation
13	Safe Inhibit	Normal Operation

9902 = 6	Open	Closed
1	+24 Volt Common	
2	Stop	Run
3	Forward Rotation	Reverse Rotation
4	Selected Speed ref	Preset Speed 1 ( <b>1202</b> )
5	+10 Volt	
6	Analog Input 1	
7	0 Volts	
8		
9	0 Volts	
10	External Trip ("F0014")	
11		
12	Safe Inhibit	Normal Operation
13	Safe Inhibit	Normal Operation

9902 = 7	Open	Closed
1	+24 Volt Common	
2	Stop	Run
3	Forward Rotation	Reverse Rotation
4		
5	T4	T6
6	Open	Open
7	Closed	Open
8	Open	Closed
9	Closed	Closed
10	Preset	
11	<b>1202</b>	
12	<b>1203</b>	
13	<b>1204</b>	
14	<b>1205</b>	
9	0 Volts	
10	External Trip ("F0014")	
11		
12	Safe Inhibit	Normal Operation
13	Safe Inhibit	Normal Operation

9902 = 8	Open	Closed
1	+24 Volt Common	
2	Stop	Run
3	Forward Rotation	Reverse Rotation
4		
5	T4	T6
6	Open	Open
7	Closed	Open
8	Open	Closed
9	Closed	Closed
10	Preset	
11	<b>1202</b>	
12	<b>1203</b>	
13	<b>1204</b>	
14	<b>1205</b>	
9	0 Volts	
10	Decel ramp 1 ( <b>2203</b> )	Decel ramp 2 ( <b>2206</b> )
11		
12	Safe Inhibit	Normal Operation
13	Safe Inhibit	Normal Operation

9902 = 9	Open	Closed
1	+24 Volt Common	
2	Stop	Run
3	Forward Rotation	Reverse Rotation
4		
5	T4	T6
6	Open	Open
7	Closed	Open
8	Open	Closed
9	Closed	Closed
10	Preset	
11	<b>1202</b>	
12	<b>1203</b>	
13	<b>1204</b>	
14	<b>1205</b>	
9	0 Volts	
10	Selected Speed ref	Preset Speeds
11		
12	Safe Inhibit	Normal Operation
13	Safe Inhibit	Normal Operation

9902 = 10	Open	Closed
1	+24 Volt Common	
2	Stop	Run
3	Forward Rotation	Reverse Rotation
4		Increase Speed <sup>1)</sup>
5		
6		Decrease Speed <sup>1)</sup>
7		
8		
9	0 Volts	
10	Selected Speed ref	Preset Speed 1 ( <b>1202</b> )
11		
12	Safe Inhibit	Normal Operation
13	Safe Inhibit	Normal Operation

1) Increase/Decrease speed function only works if parameter **1103** = 1 or 2.

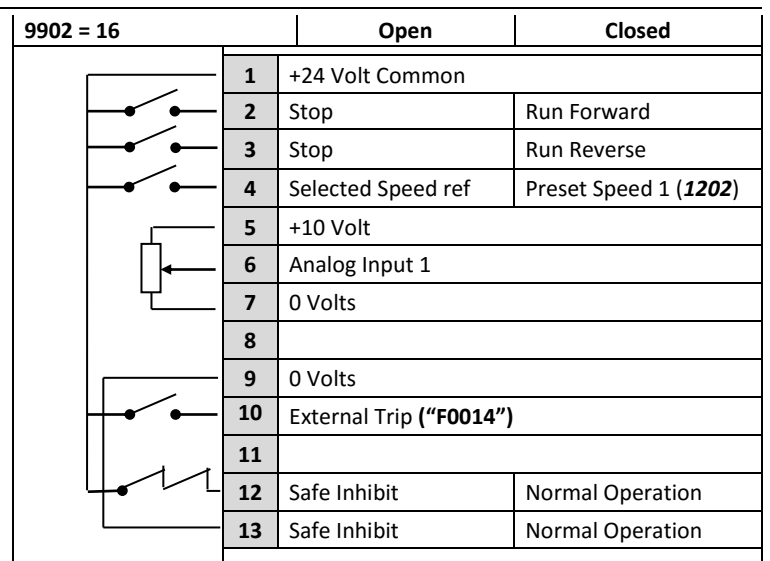
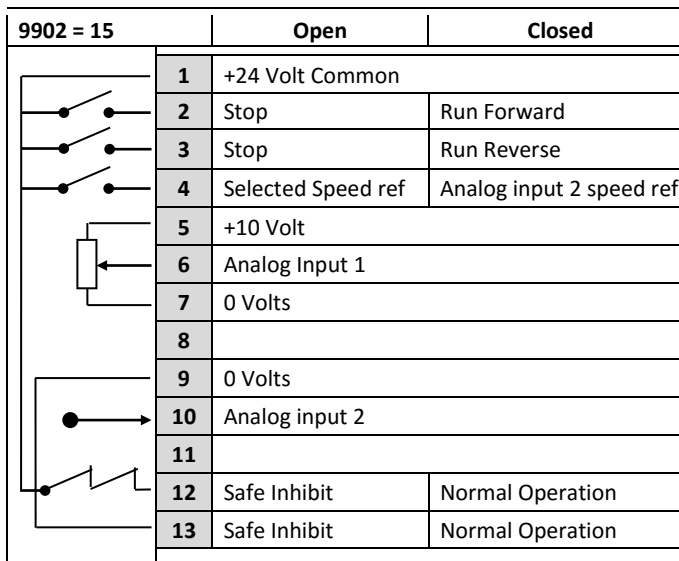
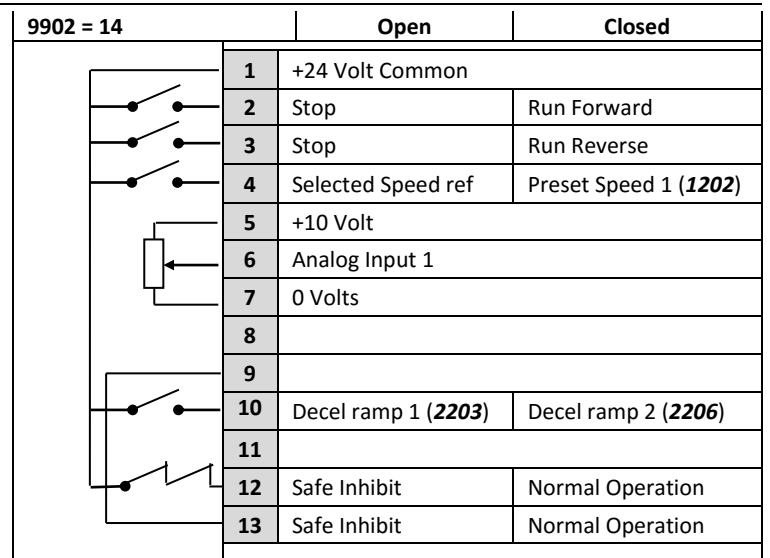
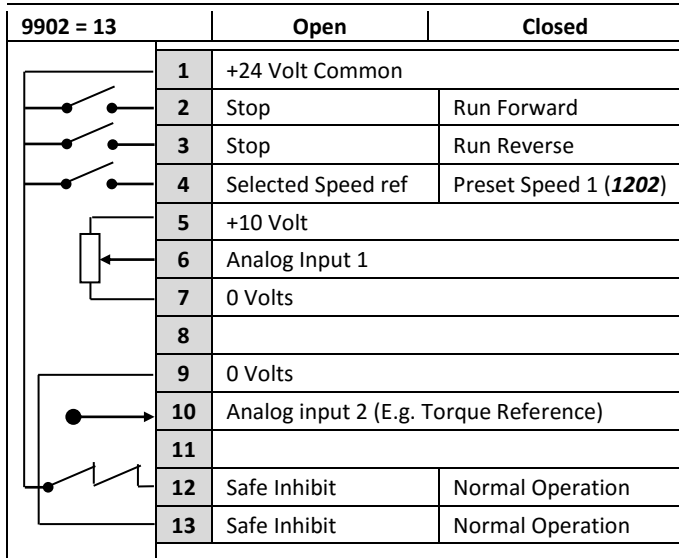
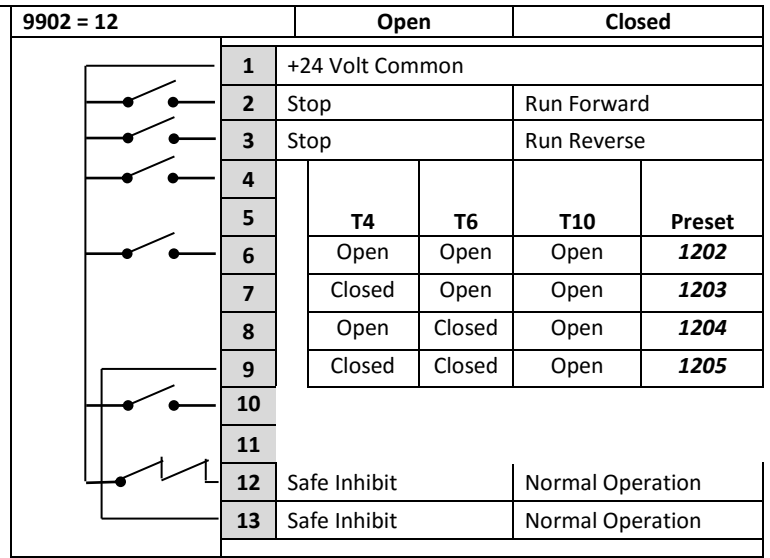
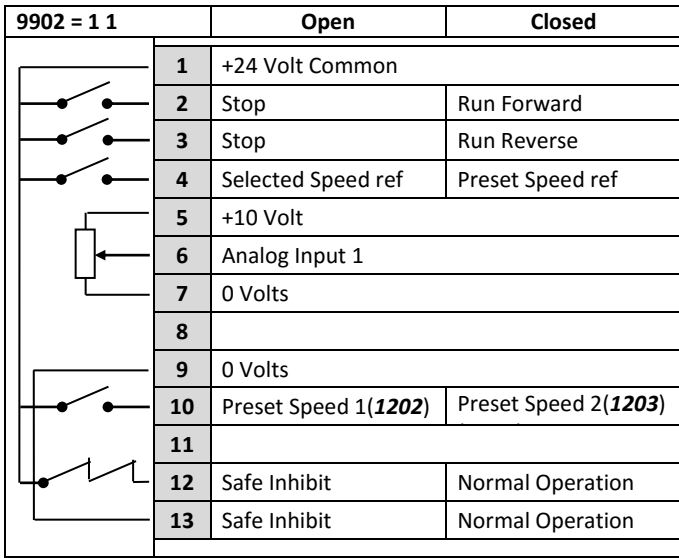

9902 = 17	Open	Closed															
1	+24 Volt Common																
2	Stop	Run Forward															
3	Stop	Run Reverse															
4	<table border="1"> <thead> <tr> <th>T4</th> <th>T6</th> <th>Preset</th> </tr> </thead> <tbody> <tr> <td>Open</td> <td>Open</td> <td><b>1202</b></td> </tr> <tr> <td>Closed</td> <td>Open</td> <td><b>1203</b></td> </tr> <tr> <td>Open</td> <td>Closed</td> <td><b>1204</b></td> </tr> <tr> <td>Closed</td> <td>Closed</td> <td><b>1205</b></td> </tr> </tbody> </table>		T4	T6	Preset	Open	Open	<b>1202</b>	Closed	Open	<b>1203</b>	Open	Closed	<b>1204</b>	Closed	Closed	<b>1205</b>
T4	T6	Preset															
Open	Open	<b>1202</b>															
Closed	Open	<b>1203</b>															
Open	Closed	<b>1204</b>															
Closed	Closed	<b>1205</b>															
5																	
6																	
7																	
8																	
9	0 Volts																
10	External Trip ("F0014")																
11																	
12	Safe Inhibit	Normal Operation															
13	Safe Inhibit	Normal Operation															

9902 = 18	Open	Closed															
1	+24 Volt Common																
2	Stop	Run Forward															
3	Stop	Run Reverse															
4	<table border="1"> <thead> <tr> <th>T4</th> <th>T6</th> <th>Preset</th> </tr> </thead> <tbody> <tr> <td>Open</td> <td>Open</td> <td><b>1202</b></td> </tr> <tr> <td>Closed</td> <td>Open</td> <td><b>1203</b></td> </tr> <tr> <td>Open</td> <td>Closed</td> <td><b>1204</b></td> </tr> <tr> <td>Closed</td> <td>Closed</td> <td><b>1205</b></td> </tr> </tbody> </table>		T4	T6	Preset	Open	Open	<b>1202</b>	Closed	Open	<b>1203</b>	Open	Closed	<b>1204</b>	Closed	Closed	<b>1205</b>
T4	T6	Preset															
Open	Open	<b>1202</b>															
Closed	Open	<b>1203</b>															
Open	Closed	<b>1204</b>															
Closed	Closed	<b>1205</b>															
5																	
6																	
7																	
8																	
9	0 Volts																
10	Decel ramp 1 ( <b>2203</b> )	Decel ramp 2 ( <b>2206</b> )															
11																	
12	Safe Inhibit	Normal Operation															
13	Safe Inhibit	Normal Operation															

9902 = 19	Open	Closed															
1	+24 Volt Common																
2	Stop	Run Forward															
3	Stop	Run Reverse															
4	<table border="1"> <thead> <tr> <th>T4</th> <th>T6</th> <th>Preset</th> </tr> </thead> <tbody> <tr> <td>Open</td> <td>Open</td> <td><b>1202</b></td> </tr> <tr> <td>Closed</td> <td>Open</td> <td><b>1203</b></td> </tr> <tr> <td>Open</td> <td>Closed</td> <td><b>1204</b></td> </tr> <tr> <td>Closed</td> <td>Closed</td> <td><b>1205</b></td> </tr> </tbody> </table>		T4	T6	Preset	Open	Open	<b>1202</b>	Closed	Open	<b>1203</b>	Open	Closed	<b>1204</b>	Closed	Closed	<b>1205</b>
T4	T6	Preset															
Open	Open	<b>1202</b>															
Closed	Open	<b>1203</b>															
Open	Closed	<b>1204</b>															
Closed	Closed	<b>1205</b>															
5																	
6																	
7																	
8																	
9	0 Volts																
10	Selected Speed ref	Preset Speeds															
11																	
12	Safe Inhibit	Normal Operation															
13	Safe Inhibit	Normal Operation															

9902 = 20	Open	Closed
1	+24 Volt Common	
2	Stop	Run Forward
3	Stop	Run Reverse
4		Increase Speed <sup>1)</sup>
5		
6		Decrease Speed <sup>1)</sup>
7		
8		
9	0 Volts	
10	Selected Speed ref	Preset Speed 1 ( <b>1202</b> )
11		
12	Safe Inhibit	Normal Operation
13	Safe Inhibit	Normal Operation

2) Increase/Decrease speed function only works if parameter **1103** = 1 or 2.

9902 = 21	Open	Closed
1	+24 Volt Common	
2	N.O. Contact-Start Forward	
3	N.C. Closed Contact - Stop	
4	N.O. Contact-Start Reverse	
5	+10 Volt	+10 Volt
6	Analog Input 1	Analog Input 1
7	0 Volts	0 Volts
8		
9	0 Volts	
10	Selected Speed ref	Preset Speed 1 ( <b>1202</b> )
11		
12	Safe Inhibit	Normal Operation
13	Safe Inhibit	Normal Operation

## 9. Parameters

### 9.1. Parameter Structure

The parameters within the drive are split into 2 groups, group 1 is titled “Short Parameter mode” displayed as “Par S” on the drive display and group 2 is titled “Long Parameter mode” displayed as “Par L” on the drive display.

- “Par S” group brings together the most commonly used parameters to aid quick setup.
- “Par L” group includes all of the drive parameters.

#### 9.1.1. Group Navigation.

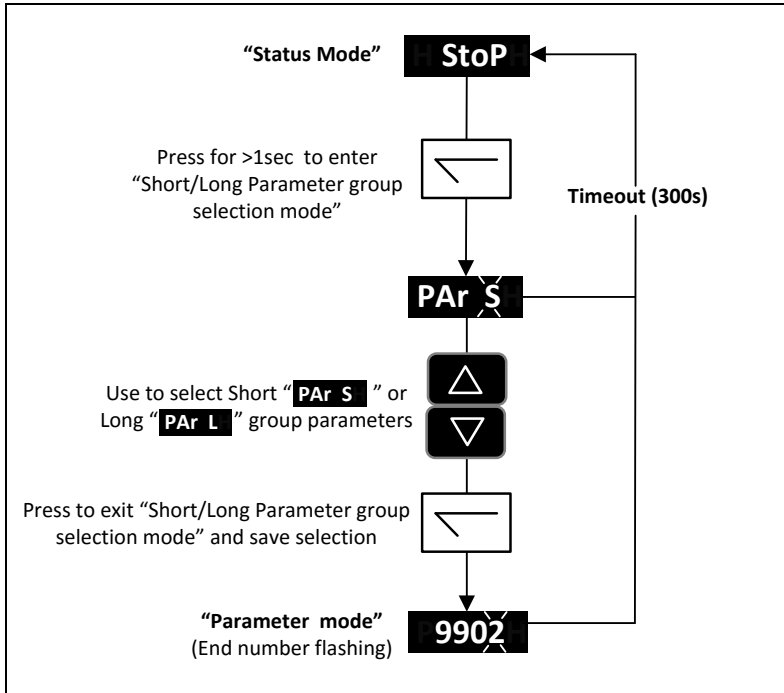

#### 9.1.2. Parameter Structure table.

PAR S	PAR L
Parameter No.	Parameter No.
9902	0000
9905	0401
9906	1100
9907	1103
0401	1202
1103	1203
1202	1204
1203	1205
1204	
1301	3400
2008	4001
2102	4002
2202	4005
	4010
	4011
	4016
	5302
	9902
	9905
	9906
	9907
	9908

## 9.2. Parameters in the Short parameter mode

The following table describes the parameters that are visible in the Short parameter mode. See section 9.1 on page 38 for how to select the parameter mode. All parameters are presented in detail in section Parameters in the Long parameter mode.

Parameters in the Short parameter mode			
No.	Name/Value	Description	Def
<b>99 START-UP DATA</b>		Application macros. Definition of motor set-up data. As shown in section 8.1 Parameter <b>9902</b> has a number of pre-programmed parameter sets (and terminal functions) which the user selects to best suit the application requirements.	
9902	DIGITAL INPUTS FUNCTION SELECT	Defines the function of the digital inputs depending on the control mode setting in Parameter <b>1103</b> PRIMARY COMMAND SOURCE MODE. (See section 8.1 for further detail)	1
9905	MOTOR RATED VOLTAGE	This parameter should be set to the rated (nameplate) voltage of the motor (Volts).	Drive Rating Dependent
	0...660V	Voltage  <b>Note</b> : The stress on the motor insulation is always dependant on the drive supply voltage. This also applies in the case where the motor voltage rating is lower than the rating of the drive and the supply of the drive.	
9906	MOTOR RATED CURRENT	This parameter should be set to the rated (nameplate) current of the motor.	Drive Rating Dependent
	0.2* drive rated output current...1.0* drive rated output current	Current	
9907	MOTOR RATED FREQUENCY	This parameter should be set to the rated (nameplate) frequency of the motor	60Hz
	25...500Hz	Frequency	
<b>04 FAULT HISTORY</b>		Fault history (read only)	
0401	Trip History Log	Displays the last four fault codes for the drive. Refer to section 13.1 for further information	-
<b>11 REFERENCE SELECT</b>		The drive can accept a variety of references in addition to the conventional analog input, potentiometer and keypad signals.	
1103	PRIMARY COMMAND SOURCE MODE		0: Terminal Control
	0: TERMINAL CONTROL	The drive responds directly to signals applied to the control terminals.	
	1: UNI-DIRECTIONAL KEYPAD CONTROL	The drive can be controlled in the forward direction only using an external or remote Keypad.	
	2: BI-DIRECTIONAL KEYPAD CONTROL.	The drive can be controlled in the forward and reverse directions using an external or remote Keypad. Pressing the keypad START button toggles between forward and reverse.	
	3: PI CONTROL	The output frequency is controlled by the internal PI controller.	
	4: FIELDBUS CONTROL	Control via Modbus RTU.	
	5 : CAN BUS CONTROL.	Control via CAN bus connected to the RJ45 serial interface connector	
<b>12 CONSTANT SPEEDS</b>		Constant speeds. Constant speed activation overrides the external speed reference. Constant speed selections are ignored if the drive is in the local control mode.  Refer to section 8.1 for how to make constant speed selections from the drive control terminals.  Preset Speeds / Frequencies selected by digital inputs depending on the setting of Parameter <b>9902</b> . If Parameter <b>9908</b> = 0, the values are entered as Hz. If Parameter <b>9908</b> > 0, the values are entered as Rpm. Setting a negative value will reverse the direction of motor rotation.	
1202	Preset / Jog Frequency / Speed 1	Defines constant speed 1 (that is the drive output frequency)	5.0Hz/RPM
	<b>2007...-2008</b>	Output Frequency	
1203	Preset / Jog Frequency / Speed 2	Defines constant speed 2 (that is the drive output frequency)	10.0Hz/RPM
	<b>2007...-2008</b>	Output Frequency	
1204	Preset / Jog Frequency / Speed 3	Defines constant speed 3 (that is the drive output frequency)	25.0Hz/RPM
	<b>2007...-2008</b>	Output Frequency	



Parameters in the Short parameter mode			
No.	Name/Value	Description	Def
<b>13 ANALOG INPUTS</b>			
Analog input signal offset			
1301	ANALOG INPUT 1 OFFSET	Sets an offset, as a percentage of the full scale range of the input, which is applied to the analog input signal	0.0%
	-500...500 %	Value in percent of the full scale range of the input Example: If the analog input signal format is 0-10V, offset = 20% . An analog input signal level of 7 Volts gives the following result :- Analog input level (%) = 7/10 = 70% Result = 70-20 (%) = 50%	
<b>20 LIMITS</b>			
Maximum frequency			
2008	MAXIMUM FREQUENCY / SPEED LIMIT	Maximum output frequency or motor speed limit – Hz or rpm. If parameter <b>9908</b> MOTOR RATED SPEED >0, the value entered / displayed is in Rpm	60.0 Hz
	<b>2007</b> ...500.0 Hz	Maximum frequency	
<b>21 START/STOP</b>			
Stop mode of the motor			
2102	STOP MODE	Selects the motor stop function	0 = Ramp to stop
	0 : Ramp To Stop	When the enable signal is removed, the drive will ramp to stop, with the rate controlled by parameter <b>2203</b> DECEL RAMP TIME as described above. In this mode, the drive brake transistor is disabled	
	1 : Coast to Stop	When the enable signal is removed, the drive output is immediately disabled, and the motor will coast (freewheel) to stop. If the load can continue to rotate due to inertia, and the drive may possibly be re-enabled whilst the motor is still rotating, the spin start function (Parameter <b>2101</b> SPIN START ENABLE) should be enabled. In this mode, the drive brake transistor is disabled.	
	2 : Ramp To Stop	When the enable signal is removed, the drive will ramp to stop, with the rate controlled by Parameter <b>2203</b> DECEL RAMP TIME as described above. The ACS255 Brake chopper is also enabled in this mode.	
	3 : Coast to Stop	When the enable signal is removed, the drive output is immediately disabled, and the motor will coast (freewheel) to stop. If the load can continue to rotate due to inertia, and the drive may possibly be re-enabled whilst the motor is still rotating, the spin start function (Parameter <b>2101</b> SPIN START ENABLE) should be enabled. The drive brake chopper is enabled in this mode, however it will only activate when required during a change in the drive frequency setpoint, and will not activate when stopping.	
<b>22 ACCEL/DECEL</b>			
Acceleration and deceleration times			
2202	ACCELERATION RAMP TIME	Acceleration ramp time from 0 to base speed (Parameter <b>9907</b> MOTOR RATED FREQUENCY) in seconds.	5.0 s
	0.00...600.0 s	Time	
2203	DECELERATION RAMP TIME	Deceleration ramp time from base speed (Parameter <b>9907</b> MOTOR RATED FREQUENCY) to standstill in seconds. When set to zero, fastest possible ramp time without trip is activated.	5.0 s
	0.00...600.0 s	Time	









### 9.3. Read Only Status parameters

#### 9.3.1. Read Only Status parameter access and navigation.

The user must be in the **Long Parameter group** to gain access to the Read only status parameters. See section 9.1.1 for how to navigate to the long parameter group.

In the Long Parameter Group when the user scrolls to parameter “0000”, pressing  will display “0104”, the User can then scroll to the required Read only status parameter (as listed in the table above). Pressing  once more will then display the value of that particular Read only status parameter.

For those parameters which have multiple values (e.g. software ID parameter **3301**), pressing the  and  keys will display the different values within that parameter.

Pressing  returns to the next level up. If  is then pressed again (without pressing  or ) the display changes to the next level up (main parameter level, i.e. Parameter “0000”).

The following table includes the descriptions of all Read Only status parameters.

Actual signals		
No.	Name/Value	Description
<b>01 OPERATING DATA</b>		
		Basic signals for monitoring the drive (read-only). For selection of an actual signal to be displayed on the control panel, see parameter <b>3405</b> DISPLAY SCALING SOURCE.
0102	ROTOR SPEED (ESTIMATED)	In Vector control mode, this parameter displays the estimated rotor speed of the motor.
0105	OUTPUT TORQUE	Displays the instantaneous output torque level produced by the motor in %.
0107	DC BUS VOLTAGE	Displays the instantaneous DC Bus Voltage internally within the drive in V DC.
0109	APPLIED MOTOR VOLTAGE	Displays the instantaneous output voltage from the drive to the motor V AC.
0110	DRIVE TEMPERATURE	Displays the Instantaneous Heatsink Temperature measured by the drive in °C.
0111	PRE RAMP SPEED CONTROLLER REFERENCE	Displays the set point reference input applied to the drive internal speed controller in Hz.
0112	TORQUE CONTROLLER REFERENCE	Displays the set point reference input applied to the drive internal torque controller in %.
0113	DIGITAL SPEED REFERENCE (MOTORISED POT)	Displays the value of the drive internal Motorised Pot (used for keypad) speed reference in Hz.
0115	ENERGY CONSUMPTION kWh METER	Displays the amount of energy consumed by the drive in kWh. When the value reaches 1000, it is reset back to 0.0, and the value of Parameter <b>0141</b> (*MWh meter) is increased.
0120	ANALOG INPUT 1 APPLIED SIGNAL LEVEL	Displays the signal level applied to analog input 1 (Terminal 6) in % after scaling and offsets have been applied.
0121	ANALOG INPUT 2 APPLIED SIGNAL LEVEL	Displays the signal level applied to analog input 2 (Terminal 10) in % after scaling and offsets have been applied.
0126	PI CONTROLLER OUTPUT	Displays the output level of the PI controller in %.
0128	PI REFERENCE (SETPOINT)	Displays the setpoint input to the PI controller in %.
0130	PI FEEDBACK LEVEL	Displays the Feedback input signal to the PI controller in %.
0135	FIELDBUS COMMUNICATION SPEED REFERENCE	Displays the setpoint being received by the drive from the currently active Fieldbus interface in Hz.
0140	DRIVE LIFETIME OPERATING TIME	Displays the total operating time of the drive. The first value shown is the number of hours. Pressing the Up key will display the minutes and seconds. (HH:MM:SS)
0141	ENERGY CONSUMPTION MWh METER	Displays the amount of energy consumed by the drive in MWh.
0160	DIGITAL INPUT STATUS	Displays the status of the drive inputs, starting with the left hand side digit = Digital Input 1 etc.
0181	MOTOR MAGNETISING CURRENT (Id)	Displays the motor magnetising Current in AMPS providing an auto tune has been successfully completed.
0182	MOTOR ROTOR CURRENT (Iq)	Displays the motor Rotor (torque producing) current in Amps, providing an auto tune has been successfully completed.
0183	DC BUS VOLTAGE RIPPLE LEVEL	Displays the level of ripple present on the DC Bus Voltage in V DC. This parameter is used by the ACS255 for various internal protection and monitoring functions.
0184	MOTOR STATOR RESISTANCE (Rs)	Displays the measured motor stator resistance in ohms, providing an auto tune has been successfully completed.
0185	MOTOR STATOR INDUCTANCE (Ls)	Displays the measured motor stator inductance in H, providing an auto tune has been successfully completed.
0186	MOTOR ROTOR RESISTANCE (Rr)	Displays the measured motor rotor resistance in ohms, providing an auto tune has been successfully completed.
0188	OPERATING TIME ACCUMULATED WITH HEATSINK TEMPERATURE ABOVE 80°C	Displays the amount of time in hours and minutes that the ACS255 has operated for during its lifetime with a heatsink temperature in excess of 80°C. This parameter is used by the ACS255 for various internal protection and monitoring functions. (HH:MM:SS)

Actual signals			
No.	Name/Value	Description	Def
0189	OPERATING TIME ACCUMULATED WITH AMBIENT TEMPERATURE ABOVE 80°C	Displays the amount of time in hours and minutes that the ACS255 has operated for during its lifetime with an ambient temperature in excess of 80°C. This parameter is used by the ACS255 for various internal protection and monitoring functions. (HH:MM:SS)	
0190	DRIVE INTERNAL COOLING FAN TOTAL OPERATING TIME	Displays the total operating time of the ACS255 internal cooling fans. The first value shown is the number of hours. Pressing the Up key will display the minutes and seconds. This is used for scheduled maintenance information (HH:MM:SS)	
0191	DC BUS VOLTAGE LOG (256ms) (V DC)	These parameters are used to store the history of various measured levels within the drive at various regular time intervals prior to a trip. The values are frozen when a fault occurs and can be used for	
0192	DC BUS VOLTAGE RIPPLE LOG (20ms) (V DC)		
0193	HEATSINK TEMPERATURE LOG (30s) (°C)		
0194	AMBIENT TEMPERATURE LOG (30s) (°C)		
0195	MOTOR CURRENT LOG (256ms) (A)		
<b>04 FAULT HISTORY</b>		Fault history (read-only)	
0402	DRIVE RUN TIME SINCE LAST TRIP (1)	Displays the total operating time of the drive since the last fault occurred. The first value shown is the number of hours. Pressing the Up key will display the minutes and seconds. (HH:MM:SS)	
0415	DRIVE RUN TIME SINCE LAST TRIP (2)	Displays the total operating time of the drive since the last fault occurred. The first value shown is the number of hours. Pressing the Up key will display the minutes and seconds. (HH:MM:SS)	
0416	DRIVE RUN TIME SINCE LAST DISABLE	Displays the total operating time of the drive since the last Run command was received. The first value shown is the number of hours. Pressing the Up key will display the minutes and seconds. (HH:MM:SS)	
0417	INTERNAL EFFECTIVE SWITCHING FREQUENCY	Displays the actual output switching frequency which the drive is currently operating at.	
0423	INTERNAL I/O COMMS ERROR COUNT	0...65535	
0424	INTERNAL DSP COMMS ERROR COUNT	0...65535	
0425	MODBUS COMMS ERROR COUNT	0...65535	
0426	CANBUS COMMS ERROR COUNT	0...65535	
<b>33 INFORMATION</b>		Firmware package version, serial number etc..	
3301	SOFTWARE VERSION AND CHECKSUM	Displays the software version of the drive.	
3303	DRIVE SERIAL NUMBER	Displays the unique serial number of the drive.	
3304	DRIVE TYPE	Displays the type details of the drive.	

## 9.4. Parameters in the Long parameter mode

The following table includes the complete descriptions of all parameters that are visible only in the Long parameter mode. See section 9.1 on page 38 for how to select the parameter mode.

Parameters in the Long parameter mode			
Index	Name/Selection	Description	Def
0000	Read only parameters access	Press the  button when in this parameter to access the read only parameters as listed in section 9.3 on page 41.	-
04	FAULT HISTORY	Fault history (read-only)	
0401	TRIP HISTORY LOG	Displays the last four fault codes for the drive. Refer to section 13.1 for further information.	-
11	REFERENCE SELECT	The drive can accept a variety of references in addition to the conventional analog input, potentiometer and keypad signals.	
1100	KEYPAD MODE RESTART SPEED	This parameter is only active when parameter <b>1103</b> = 1 or 2. When settings 0 to 3 are used, the drive must be started by pressing the Start key on the keypad. When settings 4 – 7 are used, the drive starting is controlled by the enable digital input.	1 : Previous Operating Speed
	0 : MINIMUM SPEED	Following a stop and restart, the drive will always initially run at the minimum speed parameter <b>2007</b> MIN SPEED LIMIT.	
	1 : PREVIOUS OPERATING SPEED	Following a stop and restart, the drive will return to the last keypad setpoint speed used prior to stopping	
	2 : CURRENT RUNNING SPEED	Where the ACS255 is configured for multiple speed references (typically Hand / Auto control or Local / Remote control), when switched to keypad mode by a digital input, the drive will continue to operate at the last operating speed	
	3 : PRESET SPEED 4	Following a stop and restart, the ACS255 will always initially run at Preset Speed 4 (Par <b>1205</b> )	
	4 : MINIMUM SPEED (TERMINAL ENABLE)	Following a stop and restart, the drive will always initially run at the minimum speed parameter <b>2007</b> MIN SPEED LIMIT.	
	5 : PREVIOUS OPERATING SPEED (TERMINAL ENABLE)	Following a stop and restart, the drive will return to the last keypad setpoint speed used prior to stopping.	
	6 : CURRENT RUNNING SPEED (TERMINAL ENABLE)	Where the ACS255 is configured for multiple speed references (typically Hand / Auto control or Local / Remote control), when switched to keypad mode by a digital input, the drive will continue to operate at the last operating speed	
	7 : PRESET SPEED 4 (TERMINAL ENABLE).	Following a stop and restart, the ACS255 will always initially run at Preset Speed 4 (Par <b>1205</b> )	
1103	PRIMARY COMMAND SOURCE MODE		0: Terminal Control
	0: TERMINAL CONTROL	The drive responds directly to signals applied to the control terminals.	
	1: UNI-DIRECTIONAL KEYPAD CONTROL	The drive can be controlled in the forward direction only using an external or remote Keypad.	
	2: BI-DIRECTIONAL KEYPAD CONTROL.	The drive can be controlled in the forward and reverse directions using an external or remote Keypad. Pressing the keypad START button toggles between forward and reverse.	
	3: PI CONTROL	The output frequency is controlled by the internal PI controller.	
	4: FIELDBUS CONTROL	Control via Modbus RTU.	
	5 : CAN BUS CONTROL.	Control via CAN bus connected to the RJ45 serial interface connector	

Parameters in the Long parameter mode			
Index	Name/Selection	Description	Def
<b>12</b>	<b>CONSTANT SPEEDS</b>	<p>Constant speed selection and values.</p> <p>It is possible to have four constant speeds (positive or negative values).</p> <p>Constant speeds. Constant speed activation overrides the external speed reference. Constant speed selections are ignored if the drive is in the local control mode.</p> <p>Refer to section 8.1 for how to make constant speed selections from the drive control terminals.</p> <p>Preset Speeds / Frequencies selected by digital inputs depending on the setting of Parameter <b>9902</b>.</p> <p>If Parameter <b>9908</b> = 0, the values are entered as Hz. If Parameter <b>9908</b> &gt; 0, the values are entered as Rpm.</p> <p>Setting a negative value will reverse the direction of motor rotation.</p>	
1202	PRESET / JOG FREQUENCY / SPEED 1	Defines constant speed 1 (that is the drive output frequency)	5.0Hz/RPM
	<b>2007...-2008</b>	Output Frequency	
1203	PRESET / JOG FREQUENCY / SPEED 2	Defines constant speed 2 (that is the drive output frequency)	10.0Hz/RPM
	<b>2007...-2008</b>	Output Frequency	
1204	PRESET / JOG FREQUENCY / SPEED 3	Defines constant speed 3 (that is the drive output frequency)	25.0Hz/RPM
	<b>2007...-2008</b>	Output Frequency	
1205	PRESET / JOG FREQUENCY / SPEED 4	Defines constant speed 4 (that is the drive output frequency)	60.0Hz/RPM
	<b>2007...-2008</b>	Output Frequency	
<b>13</b>	<b>ANALOG INPUTS</b>	Analog input signal processing	
1300	ANALOG INPUT 1 (TERMINAL 6) FORMAT	Selects the type of reference source into terminal 6.	<b>U 0- 10</b>
	<b>U 0- 10</b>	0 to 10 Volt Signal (Uni-polar)	
	<b>U 10-0</b>	10 to 0 Volt Signal (Uni-polar)	
	<b>- 10- 10</b>	-10 to +10 Volt Signal (Bi-polar)	
	<b>A 0-20</b>	0 to 20mA Signal	
	<b>t 4-20</b>	4 to 20mA Signal, the ACS255 will trip and show the fault code <b>4- 20F</b> if the signal level falls below 3mA	
	<b>r 4-20</b>	4 to 20mA Signal, the ACS255 will ramp to stop if the signal level falls below 3 mA	
	<b>t 20-4</b>	20 to 4mA Signal, the ACS255 will trip and show the fault code <b>4- 20F</b> if the signal level falls below 3mA	
	<b>r 20-4</b>	20 to 4mA Signal, the ACS255 will ramp to stop if the signal level falls below 3mA	
1301	ANALOG INPUT 1 OFFSET	Sets an offset, as a percentage of the full scale range of the input, which is applied to the analog input signal	0.0%
	-500...500 %	<p>Value in percent of the full scale range of the input</p> <p>Example: If the analog input signal format is 0-10V, offset = 20% .</p> <p>An analog input signal level of 7 Volts gives the following result :-</p> <p>Analog input level (%) = 7/10 = 70%</p> <p>Result = 70-20 (%) = 50%</p>	
1302	ANALOG INPUT 1 SCALING	Scales the analog input by this factor, (as a percentage of the full scale range of this input).	100.0%
	0.0...2000.0 %	Example: If parameter <b>1300</b> ANALOG INPUT 1 FORMAT is set for 0 – 10V, and the scaling factor is set to 200.0%, a 5 volt input will result in the drive running at maximum speed as set in parameter <b>2008</b> MAX SPEED LIMIT	
1304	ANALOG INPUT 2 (TERMINAL 10) FORMAT	Selects the type of reference source into terminal 10.	<b>U 0- 10</b>
	<b>U 0- 10</b>	0 to 10 Volt Signal (Uni-polar)	
	<b>U 10-0</b>	10 to 0 Volt Signal (Uni-polar)	
	<b>Ptc-tt</b>	Motor PTC Thermistor Input	
	<b>A 0-20</b>	0 to 20mA Signal	
	<b>t 4-20</b>	4 to 20mA Signal, the ACS255 will trip and show the fault code <b>4- 20F</b> if the signal level falls below 3mA	
	<b>r 4-20</b>	4 to 20mA Signal, the ACS255 will ramp to stop if the signal level falls below 3 mA	
	<b>t 20-4</b>	20 to 4mA Signal, the ACS255 will trip and show the fault code <b>4- 20F</b> if the signal level falls below 3mA	

Parameters in the Long parameter mode			
Index	Name/Selection	Description	Def
1305	ANALOG INPUT 2 OFFSET	Sets an offset, as a percentage of the full scale range of the input, which is applied to the analog input signal	0.0%
	-500...500 %	Value in percent of the full scale range of the input Example: If the analog input signal format is 0-10V, offset = 20% . An analog input signal level of 7 Volts gives the following result :- Analog input level (%) = 7/10 = 70% Result = 70-20 (%) = 50%	
1307	ANALOG INPUT 2 SCALING	Scales the analog input by this factor, (as a percentage of the full scale range of this input).	100.0%
	0.0...2000.0 %	Example: If parameter <b>1304</b> ANALOG INPUT 2 FORMAT is set for 0 – 10V, and the scaling factor is set to 200.0%, a 5 volt input will result in the drive running at maximum speed as set in parameter <b>2008</b> MAX SPEED LIMIT	
<b>14</b>	<b>RELAY OUTPUTS</b>	Status information indicated through relay output and relay operating delays	
1401	USER RELAY 1 OUTPUT (TERMINALS 14, 15 & 16) FUNCTION SELECT	Selects the function assigned to Relay Output 1. The relay has three output terminals, Logic 1 indicates the relay is active, and therefore terminals 14 and 15 will be linked together.  <b>Note</b> : When using settings 4 – 7, parameters <b>3203</b> USER RELAY 1 UPPER LIMIT and <b>3202</b> USER RELAY 1 LOWER LIMIT must be used together to control the behavior. The output will switch to Logic 1 when the selected signal exceeds the value programmed in parameter <b>3203</b> USER RELAY 1 UPPER LIMIT, and return to Logic 0 when the signal falls below the value programmed in parameter <b>3202</b> USER RELAY 1 LOWER LIMIT.	1: Drive Ready
	0 : DRIVE ENABLED (RUNNING).	Logic 1 when the motor is enabled.	
	1: DRIVE READY	Logic 1 when power is applied to the drive and no fault exists.	
	2 : AT TARGET FREQUENCY (SPEED)	Logic 1 when the output frequency matches the setpoint frequency.	
	3: OUTPUT FREQUENCY > 0.0 HZ	Logic 1 when the drive output frequency to the motor is exceeds 0.0Hz.	
	4 : OUTPUT FREQUENCY >= LIMIT	Logic 1 when the motor speed exceeds the adjustable limit. (See note above)	
	5 : OUTPUT CURRENT >= LIMIT	Logic 1 when the motor current exceeds the adjustable limit. (See note above)	
	6 : OUTPUT TORQUE >= LIMIT	Logic 1 when the motor torque exceeds the adjustable limit. (See note above)	
	7 : ANALOG INPUT 2 SIGNAL LEVEL >= LIMIT.	Logic 1 when the signal applied to the Analog Input 2 exceeds the adjustable limit. (See note above)	
	8 : RESERVED	No Function	
	9 : RESERVED	No Function	
	10 : RESERVED	No Function	
	11 : RESERVED	No Function	
	12 : DRIVE TRIPPED	Logic 1 when the drive has tripped and the display shows the fault code.	
	13 : STO STATUS.	Logic 1 when both STO inputs are present and the drive is able to be operated.	
1402	USER RELAY 2 OUTPUT (TERMINALS 17 & 18) FUNCTION SELECT	Selects the function assigned to Relay Output 2. The relay has three output terminals, Logic 1 indicates the relay is active, and therefore terminals 17 and 18 will be linked together.  <b>Note</b> : When using settings 4 – 7, parameters <b>3206</b> USER RELAY 2 UPPER LIMIT and <b>3205</b> USER RELAY 2 LOWER LIMIT must be used together to control the behaviour. The output will switch to Logic 1 when the selected signal exceeds the value programmed in parameter <b>3206</b> USER RELAY 2 UPPER LIMIT, and return to Logic 0 when the signal falls below the value programmed in parameter <b>3205</b> USER RELAY 2 LOWER LIMIT.	0 : Drive Enabled (Running). Logic 1 when the motor is enabled
	1: DRIVE READY	Logic 1 when power is applied to the drive and no fault exists	
	2 : AT TARGET FREQUENCY (SPEED)	Logic 1 when the output frequency matches the setpoint frequency	
	3: OUTPUT FREQUENCY > 0.0 HZ	Logic 1 when the drive output frequency to the motor is exceeds 0.0Hz	
	4 : OUTPUT FREQUENCY >= LIMIT	Logic 1 when the motor speed exceeds the adjustable limit	
	5 : OUTPUT CURRENT >= LIMIT	Logic 1 when the motor current exceeds the adjustable limit	
	6 : OUTPUT TORQUE >= LIMIT	Logic 1 when the motor torque exceeds the adjustable limit	
	7 : ANALOG INPUT 2 SIGNAL LEVEL >= LIMIT	1 Logic when the signal applied to the Analog Input 2 exceeds the adjustable limit	

Parameters in the Long parameter mode			
Index	Name/Selection	Description	Def
	9 : RESERVED.	No Function	
	10 : RESERVED	No Function	
	11 : RESERVED.	No Function	
	12 : DRIVE TRIPPED	Logic 1 when the drive has tripped and the display shows the fault code.	
	13 : STO STATUS	Logic 1 when both STO inputs are present and the drive is able to be operated	
1404	RELAY OUTPUT HYSTERESIS CONTROL	This parameter works in conjunction with parameter <b>1501</b> ANALOG OUTPUT 1 FUNCTION SELECT and <b>1507</b> ANALOG OUTPUT 2 FUNCTION SELECT = 2 or 3 to set a band around the target speed ( <b>1501</b> = 2) or zero speed ( <b>1501</b> = 3). When the speed is within this band, the drive is considered to be at target speed or Zero speed. This function is used to prevent "chatter" on the relay output if the operating speed coincides with the level at which the digital / relay output changes state. e.g. if parameter <b>1507</b> ANALOG OUTPUT 2 FUNCTION SELECT = 3, <b>2008</b> MAXIMUM FREQUENCY/SPEED LIMIT = 50Hz and parameter <b>1404</b> = 5%, the relay contacts close above 2.5Hz	0.3%
	0.0...25%		
<b>15</b>	<b>ANALOG/DIGITAL OUTPUTS</b>	Analog output signal processing	
1501	ANALOG OUTPUT 1 (TERMINAL 8) FUNCTION SELECT	Selects the type of output signal information indicated from terminal 8. <b>Note :</b> When using settings 0 – 7 the output is a digital format (Logic 1 = 24V). When using settings 8– 11 the output is an analog format.  <b>Note :</b> When using settings 4 – 7, parameters <b>3203</b> ADJUSTABLE THRESHOLD 1 UPPER LIMIT and <b>3202</b> ADJUSTABLE THRESHOLD 1 LOWER LIMIT must be used together to control the behaviour. The output will switch to Logic 1 when the selected signal exceeds the value programmed in parameters <b>3203</b> ADJUSTABLE THRESHOLD 1 UPPER LIMIT, and return to Logic 0 when the signal falls below the value programmed in <b>3202</b> ADJUSTABLE THRESHOLD 1 LOWER LIMIT.	8 : Output Frequency (Motor Speed)
	0 : DRIVE ENABLED (RUNNING)	Logic 1 when the ACS255 is enabled (Running)	
	1: DRIVE READY	Logic 1 When no Fault condition exists on the drive	
	2 : AT TARGET FREQUENCY (SPEED).	Logic 1 when the output frequency matches the setpoint frequency	
	3 : OUTPUT FREQUENCY > 0.0	Logic 1 when the motor runs above zero speed	
	4 : OUTPUT FREQUENCY >= LIMIT	Logic 1 when the motor speed exceeds the adjustable limit. (See note above)	
	5 : OUTPUT CURRENT >= LIMIT	Logic 1 when the motor current exceeds the adjustable limit. (See note above)	
	6 : MOTOR TORQUE >= LIMIT	Logic 1 when the motor torque exceeds the adjustable limit. (See note above)	
	7 : ANALOG INPUT 2 SIGNAL LEVEL >= LIMIT.	Logic 1 when the signal applied to the Analog Input 2 exceeds the adjustable limit. (See note above)	
	8 : OUTPUT FREQUENCY (MOTOR SPEED).	0 to Parameter <b>2008</b> MAXIMUM FREQUENCY/SPEED LIMIT	
	9 : OUTPUT (MOTOR) CURRENT.	0 to 200% of Parameter <b>9906</b> MOTOR RATED CURRENT	
	10 : MOTOR TORQUE.	0 to 200% of motor rated torque	
	11 : OUTPUT (MOTOR) POWER	0 to 150% of drive rated power	
1504	ANALOG OUTPUT 1 (TERMINAL 8) FORMAT	Selects the type of output signal from terminal 8	<b>U 0- 10</b>
	<b>U 0- 10</b>	0 to 10V	
	<b>U 10-0</b>	10 to 0V	
	<b>A 0-20</b>	0 to 20mA	
	<b>A 20-0</b>	20 to 0mA	
	<b>A 4-20</b>	4 to 20mA	
	<b>A 20-4</b>	20 to 4mA	

Parameters in the Long parameter mode			
Index	Name/Selection	Description	Def
1507	ANALOG OUTPUT 2 (TERMINAL 11) FUNCTION SELECT	Selects the type of output signal information indicated from terminal 11. <b>Note :</b> When using settings 0 – 7 the output is a digital format (Logic 1 = 24V). When using settings 8– 11 the output is an analog format.  <b>Note :</b> When using settings 4 – 7, parameters <b>3203</b> ADJUSTABLE THRESHOLD 1 UPPER LIMIT and <b>3202</b> ADJUSTABLE THRESHOLD 1 LOWER LIMIT must be used together to control the behaviour. The output will switch to Logic 1 when the selected signal exceeds the value programmed in parameters <b>3203</b> ADJUSTABLE THRESHOLD 1 UPPER LIMIT, and return to Logic 0 when the signal falls below the value programmed in <b>3202</b> ADJUSTABLE THRESHOLD 1 LOWER LIMIT.	9 : Output (Motor) Current.
	0 : DRIVE ENABLED (RUNNING)	Logic 1 when the ACS255 is enabled (Running)	
	1: DRIVE READY	Logic 1 When no Fault condition exists on the drive	
	2 : AT TARGET FREQUENCY (SPEED).	Logic 1 when the output frequency matches the setpoint frequency	
	3 : OUTPUT FREQUENCY > 0.0	Logic 1 when the motor runs above zero speed	
	4 : OUTPUT FREQUENCY >= LIMIT	Logic 1 when the motor speed exceeds the adjustable limit. (See note above)	
	5 : OUTPUT CURRENT >= LIMIT	Logic 1 when the motor current exceeds the adjustable limit. (See note above)	
	6 : MOTOR TORQUE >= LIMIT	Logic 1 when the motor torque exceeds the adjustable limit. (See note above)	
	7 : ANALOG INPUT 2 SIGNAL LEVEL >= LIMIT.	Logic 1 when the signal applied to the Analog Input 2 exceeds the adjustable limit. (See note above)	
	8 : OUTPUT FREQUENCY (MOTOR SPEED).	0 to Parameter <b>2008</b> MAXIMUM FREQUENCY/SPEED LIMIT	
	9 : OUTPUT (MOTOR) CURRENT.	0 to 200% of Parameter <b>9906</b> MOTOR RATED CURRENT	
	10 : MOTOR TORQUE.	0 to 200% of motor rated torque	
	11 : OUTPUT (MOTOR) POWER	0 to 150% of drive rated power	
1508	ANALOG OUTPUT 2 (TERMINAL 11) FORMAT	Selects the type of output signal from terminal 11	<b>U 0- 10</b>
	<b>U 0- 10</b>	0 to 10V	
	<b>U 10-0</b>	10 to 0V	
	<b>A 0-20</b>	0 to 20mA	
	<b>A 20-0</b>	20 to 0mA	
	<b>A 4-20</b>	4 to 20mA	
	<b>A 20-4</b>	20 to 4mA	
<b>16 SYSTEM CONTROLS</b>		Run enable, parameter lock etc.	
1602	PARAMETER ACCESS UNLOCK	If parameter <b>1603</b> PARAMETER ACCESS CODE DEFINITION has had a value entered, then the matching value needs to be entered here in order to give read-write access to the parameters.	0
	0...65535	See section 9.5 for more details	
1603	PARAMETER ACCESS CODE DEFINITION	To make all parameters read-only (except parameter <b>1602</b> Parameter Access Unlock), enter a value in this parameter.	0
	0...65535	See section 9.5 for more details	
<b>20 LIMITS</b>		Drive operation limits	
2005	OVER VOLTAGE CURRENT LIMIT	This parameter is only valid in vector speed control mode and will come into function once the drive DC bus voltage increases above a preset limit This voltage limit is set internally just below the over voltage trip level. This parameter will effectively limit the output torque current in order to prevent a large current flowing back to the drive, which may cause an Over-voltage trip. A small value in this parameter will limit the motor control torque when the drive DC bus voltage exceeds the preset limit. A higher value may cause a significant distortion in the motor current, which may cause an aggressive, rough motor behaviour.	1.0%
	0.0...100.0		

Parameters in the Long parameter mode			
Index	Name/Selection	Description	Def
2006	MAINS LOSS RIDE THROUGH / STOP CONTROL	Controls the behaviour of the drive in response to a loss of mains power supply whilst the drive is enabled.	0: Mains Loss Ride Through.
	0: MAINS LOSS RIDE THROUGH.	The ACS255 will attempt to continue operating by recovering energy from the load motor. Providing that the mains loss period is short, and sufficient energy can be recovered before the drive control electronics power off, the drive will automatically restart on return of mains power.	
	1: COAST TO STOP.	The ACS255 will immediately disable the output to the motor, allowing the load to coast or free wheel. When using this setting with high inertia loads, the Spin Start function Parameter <b>2101</b> SPIN START ENABLE may need to be enabled.	
	2: FAST RAMP TO STOP.	The drive will ramp to stop at the rate programmed in the 2 <sup>nd</sup> deceleration time as set in parameter <b>2206</b> 2 <sup>nd</sup> DECELERATION RAMP TIME.	
	3: DC BUS POWER SUPPLY MODE.	This mode is intended to be used when the drive is powered directly via the +DC and –DC Bus connections. Refer to your ABB Sales Partner for further details.	
2007	MINIMUM FREQUENCY / SPEED LIMIT	Minimum output frequency or motor speed limit – Hz or rpm. If parameter <b>9908</b> MOTOR RATED SPEED >0, the value entered / displayed is in Rpm	0.0 Hz
	0.0 HZ... <b>2008</b>	Minimum frequency	
2008	MAXIMUM FREQUENCY / SPEED LIMIT	Maximum output frequency or motor speed limit – Hz or rpm. If parameter <b>9908</b> MOTOR RATED SPEED >0, the value entered / displayed is in Rpm	60.0 Hz
	<b>2007</b> ...500.0 Hz	Maximum frequency	
2014	TORQUE CONTROL REFERENCE / LIMIT SOURCE	When parameter <b>9903</b> MOTOR CONTROL MODE = 0, this parameter defines the source for the maximum output torque limit. When parameter <b>9903</b> MOTOR CONTROL MODE = 1, this parameter defines the source for the torque reference (setpoint).	0: Fixed Digital
	0: FIXED DIGITAL	The torque controller reference / limit is set in parameter <b>2017</b> MAXIMUM MOTORING TORQUE LIMIT/CURRENT LIMIT.	
	1: ANALOG INPUT 1	The output torque is controlled based on the signal applied to Analog Input 1, whereby 100% input signal level will result in the drive output torque being limited by the value set in parameter <b>2017</b> MAXIMUM MOTORING TORQUE LIMIT/CURRENT LIMIT.	
	2: ANALOG INPUT 2	The output torque is controlled based on the signal applied to Analog Input 2, whereby 100% input signal level will result in the drive output torque being limited by the value set in parameter <b>2017</b> MAXIMUM MOTORING TORQUE LIMIT/CURRENT LIMIT..	
	3: FIELDBUS.	The output torque is controlled based on the signal from the communications Fieldbus, whereby 100% input signal level will result in the drive output torque being limited by the value set in parameter <b>2017</b> MAXIMUM MOTORING TORQUE LIMIT/CURRENT LIMIT..	
2015	MINIMUM MOTORING TORQUE LIMIT	Active only in Vector Speed or Vector Torque motor control modes ( <b>9903</b> MOTOR CONTROL MODE = 0 or 1). Sets a minimum torque limit, whereby when the ACS255 is enabled, it will always attempt to maintain this torque on the motor at all times whilst operating.  <b>WARNING</b> : This parameter should be used with extreme care, as the drive output frequency will increase to achieve the torque level, and may exceed the selected speed reference.	0.0%
	0.0 %... <b>2017</b>		
2017	MAXIMUM MOTORING TORQUE LIMIT / CURRENT LIMIT	When operating in Vector Speed or Vector Torque motor control modes ( <b>9903</b> MOTOR CONTROL MODE = 0 or 1) this parameter defines the maximum torque limit or reference used by the drive in conjunction with parameter <b>2014</b> TORQUE CONTROL REFERENCE/LIMIT SOURCE . When operating in V/F Mode ( <b>9903</b> MOTOR CONTROL MODE = 2), this parameter defines the maximum output current the drive will provide to the motor before reducing the output frequency to attempt to limit the current.	200.0%
	<b>2015</b> ...500.00 %		
2022	GENERATOR MODE MAX. TORQUE LIMIT (MAXIMUM REGENERATIVE TORQUE)	Active only in Vector Speed or Vector Torque motor control modes (parameter <b>9903</b> = 0,1,3). Sets the maximum regenerating torque allowed by the ACS255	200.0%
	0.0...500 %		
<b>21 START/STOP</b>		Start and Stop modes of the motor	
2101	SPIN START ENABLE	Starting the drive connected to a rotating motor.	0 : Disabled
	0 : DISABLED		
	1 : ENABLED	On start up the drive will attempt to determine if the motor is already rotating, and will begin to control the motor from its current speed. A short delay may be observed when starting motors which are not turning.	



Parameters in the Long parameter mode			
Index	Name/Selection	Description	Def
2102	STOP MODE	Selects the motor stop function	0 : RAMP TO STOP
	0 : RAMP TO STOP	When the enable signal is removed, the drive will ramp to stop, with the rate controlled by parameter <b>2203</b> DECEL RAMP TIME as described above. In this mode, the drive brake transistor is disabled	
	1 : COAST TO STOP	When the enable signal is removed, the drive output is immediately disabled, and the motor will coast (freewheel) to stop. If the load can continue to rotate due to inertia, and the drive may possibly be re-enabled while the motor is still rotating, the spin start function (Parameter <b>2101</b> SPIN START ENABLE) should be enabled. In this mode, the drive brake transistor is disabled.	
	2 : RAMP TO STOP	When the enable signal is removed, the drive will ramp to stop, with the rate controlled by Parameter <b>2203</b> DECEL RAMP TIME as described above. The ACS255 Brake chopper is also enabled in this mode.	
	3 : COAST TO STOP	When the enable signal is removed, the drive output is immediately disabled, and the motor will coast (freewheel) to stop. If the load can continue to rotate due to inertia, and the drive may possibly be re-enabled while the motor is still rotating, the spin start function (Parameter <b>2101</b> SPIN START ENABLE) should be enabled. The drive brake chopper is enabled in this mode, however it will only activate when required during a change in the drive frequency setpoint, and will not activate when stopping.	
2103	V/F MODE MAGNETISING PERIOD	This parameter is used to set up a minimum delay time for the magnetising current control in V/F mode when drive run signal is given. Too small a value may cause the drive to trip on over-current if the acceleration ramp is very short.	-
	0...5000 ms		
2106	DC INJECTION BRAKING VOLTAGE	Sets the amount of dc voltage as a percentage of the nominal voltage ( <b>9905</b> MOTOR RATED VOLTAGE) that is applied to the motor when a stop command is received. This parameter is enabled only for V/f control.	0.0
	<b>Aut0</b> , 0.0...25.0 %		
2108	START MODE SELECT / AUTOMATIC RESTART	Defines the behaviour of the drive relating to the enable digital input and also configures the Automatic Restart function.	<b>Aut0-0</b>
	<b>Ed9E-r</b>	Following Power on or reset, the drive will not start if Digital Input 1 remains closed. The Input must be closed after a power on or reset to start the drive.	
	<b>Aut0-0</b>	Following a Power On or Reset, the drive will automatically start if Digital Input 1 is closed.	
	<b>Aut0-1 to Aut0-5</b>	Following a trip, the drive will make up to 5 attempts to restart at 20 second intervals. The drive must be powered down to reset the counter. The numbers of restart attempts are counted, and if the drive fails to start on the final attempt, the drive will fault with, and will require the user to manually reset the fault <b>DANGER! "Aut0" modes allow the drive to Auto-start, therefore the impact on System/Personnel safety needs to be considered.</b>	
2110	LOW FREQUENCY TORQUE BOOST	Boost current applied at start-up, as % of motor rated current (Parameter <b>9906</b> Motor Rated Current). The drive provides a boost function that can inject some current into the motor at low speed to help ensure the rotor alignment is maintained and to allow effective operation of the motor at lower speeds. To implement low speed boost, run the drive at the lowest frequency required by the application and increase boost levels to provide both required torque and smooth operation.	0.0 %
	0.0...100.0 %		
2111	TORQUE BOOST FREQUENCY LIMIT	Frequency range for applied boost current (Parameter <b>2110</b> LOW FREQUENCY TORQUE BOOST) as a % of motor rated frequency (Parameter <b>9907</b> Motor Rated Frequency). This sets the frequency cut-off point above which boost current is no longer applied to the motor.	0.0 %
	0.0...50.0 %		
2112	ZERO SPEED HOLDING TIME	Determines the time for which the drive output frequency is held at zero when stopping, before the drive output is disabled	0.2 s
	0.0...60.0 s		
<b>22 ACCEL/DECEL</b>		Acceleration and deceleration times	
2202	ACCELERATION RAMP TIME	Acceleration ramp time from 0 to base speed (Parameter <b>9907</b> MOTOR RATED FREQUENCY) in seconds.	5.0 s
	0.00...600.0 s	Time	
2203	DECELERATION RAMP TIME	Deceleration ramp time from base speed (Parameter <b>9907</b> MOTOR RATED FREQUENCY) to standstill in seconds. When set to zero, fastest possible ramp time without trip is activated.	5.0 s
	0.00...600.0 s	Time	

Parameters in the Long parameter mode			
Index	Name/Selection	Description	Def
2206	2nd DECELERATION RAMP TIME	This parameter allows an alternative deceleration ramp down time to be programmed into the ACS255, which can be selected by digital inputs (dependent on the setting of Parameter <b>9902</b> DIGITAL INPUTS FUNCTION SELECT or selected automatically in the case of a mains power loss if parameter <b>2006</b> MAINS LOSS RIDE THROUGH / STOP CONTROL = 2.	0.00
	0.00...240.0 s	When set to 0.0, the drive will coast to stop.	
2210	FIELD BUS RAMP CONTROL	Selects whether the acceleration and deceleration ramps are controlled directly via the fieldbus, or by internal drive parameters <b>2202</b> ACCELERATION RAMP TIME and <b>2203</b> DECELERATION RAMP TIME.	0 : Disabled
	0 : Disabled	Ramps are controlled from internal drive parameters.	
	1 : Enabled	Ramps are controlled directly by fieldbus.	
<b>23 VECTOR CONTROL MODE OPTIMISE</b>			
2301	VECTOR SPEED CONTROLLER PROPORTIONAL GAIN	Sets the proportional gain value for the speed controller when operating in Vector Speed or Vector Torque motor control modes (parameter <b>9903</b> MOTOR CONTROL MODE = 0 ,1,3). Higher values provide better output frequency regulation and response. Too high a value can cause instability or even over current trips. For applications requiring best possible performance, the value should be adjusted to suit the connected load by gradually increasing the value and monitoring the actual output speed of the load until the required dynamic behaviour is achieved with little or no overshoot where the output speed exceeds the setpoint. In general, higher friction loads can tolerate higher values of proportional gain, and high inertia, low friction loads may require the gain to be reduced.	50.0 %
	0.1...400.0 %		
2302	VECTOR SPEED CONTROLLER INTEGRAL TIME CONSTANT	Sets the integral time for the speed controller. Smaller values provide a faster response in reaction to motor load changes, at the risk of introducing instability. For best dynamic performance, the value should be adjusted to suit the connected load.	0.050 s
	0.000...2.000 s		
2303	VECTOR SPEED CONTROL D GAIN	Sets the differential gain (%) for the speed controller in vector mode operation (parameter <b>9903</b> MOTOR CONTROL MODE = 0).	0.0 %
	0.0...400.0 %		
2305	SYSTEM INERTIA CONSTANT	System Load Inertia to Motor Inertia Ratio entered as H = (J <sub>Tot</sub> / J <sub>Mot</sub> ). This value can normally be left at the default value (10) and is used by the drive control algorithms as a feed-forward control variable to provide optimum torque current to accelerate the load. Hence accurate setting of the inertia ratio will produce a better system response and dynamics. If the value is unknown then leave this set to the default value (10).	10
	0...600		
<b>25 CRITICAL SPEEDS</b>			
		Speed bands with which the drive is not allowed to operate. The Skip Frequency function is used to avoid the ACS255 operating at a certain output frequency, for example at a frequency which causes mechanical resonance in a particular machine.	
2500	SKIP FREQUENCY BAND WIDTH	The ACS255 output frequency will ramp through the defined band at the rates set in parameter <b>2202</b> ACCELERATION RAMP TIME and parameter <b>2203</b> DECELERATION RAMP TIME respectively, and will not hold any output frequency within the defined band. If the frequency reference applied to the drive is within the band, the ACS255 output frequency will remain at the upper or lower limit of the band.	0.0 Hz/Rpm
	0.0... <b>2008</b>		
2501	SKIP FREQUENCY CENTRE POINT	Defines the center point of the skip frequency band, and is used in conjunction with Parameter <b>2500</b> SKIP FREQUENCY BAND WIDTH.	0.0 Hz/Rpm
	<b>2007...2008</b>		

Parameters in the Long parameter mode			
Index	Name/Selection	Description	Def
<b>26 MOTOR CONTROL</b>		Motor control variables	
2601	ENERGY OPTIMIZER	Only active when enhanced V/F motor control mode is selected (parameter <b>9903</b> MOTOR CONTROL MODE = 2)	0 : Disabled
	0 : DISABLED		
	1 : ENABLED	The Energy Optimizer attempts to reduce the overall energy consumed by the drive and motor when operating at constant speeds and light loads. The output voltage applied to the motor is reduced. The Energy Optimizer is intended for applications where the drive may operate for some periods of time with constant speed and light motor load, whether constant or variable torque.	
2603	V/F MODE VOLTAGE BOOST	Voltage boost is used to increase the applied motor voltage at low output frequencies, in order to improve low speed and starting torque. Excessive voltage boost levels may result in increased motor current and temperature, and force ventilation of the motor may be required. An automatic setting ( <b>Auto</b> ) is also possible, whereby the ACS255 will automatically adjust this parameter based on the motor parameters measured during an autotune.	Drive rating dependant
2606	EFFECTIVE SWITCHING FREQUENCY	Effective power stage switching frequency. The range of settings available and factory default parameter setting depend on the drive power and voltage rating. Higher frequencies reduce the audible 'ringing' noise from the motor, and improve the output current waveform, at the expense of increased drive losses. Refer to section 11.5.3 on page 60 for further information regarding operation at higher switching frequency.	Drive Rating Dependent
	4...32 kHz		
2607	AUTOMATIC THERMAL MANAGEMENT	Drive will automatically reduce the output switching frequency to this value at higher heat sink temperature, to reduce the risk of an over temperature trip.	4kHz
	4...32kHz		
2610	V/F CHARACTERISTIC ADJUSTMENT VOLTAGE	Used in conjunction with parameter <b>2611</b>	0 %
	0 %...100% of <b>9905</b>		
2611	V/F CHARACTERISTIC ADJUSTMENT FREQUENCY	When operating in V/F mode (Parameter <b>9903</b> = 2), this parameter in conjunction with parameter <b>2610</b> sets a frequency point at which the voltage set in Parameter <b>2610</b> is applied to the motor. Care must be taken to avoid overheating and damaging the motor when using this feature.	0 %
	0.0 %...100% of <b>9907</b>		
<b>30 FAULT FUNCTIONS</b>		Programmable protection functions	
3005	THERMAL OVERLOAD VALUE RETENTION		0 : DISABLED
	0 : DISABLED	Alternative means of protecting the motor from thermal overload must be applied (e.g. PTC thermistor)	
	1 : ENABLED	The drive will retain the motor thermal overload value following a mains power cycle.	
3018	COMMUNICATION LOSS ACTION	Controls the behaviour of the drive following a loss of communications as determined by the above parameter setting.	0 : Trip & Coast To Stop
	0 : TRIP & COAST TO STOP		
	1 : RAMP TO STOP THEN TRIP		
	2 : RAMP TO STOP ONLY (NO TRIP)		
	3 : RUN AT PRESET SPEED 4	Runs at the value set in parameter <b>1205</b> PRESET / JOG FREQUENCY / SPEED 4.	
3019	COMMUNICATIONS LOSS TIMEOUT	Sets the watchdog time period for the communications channel. If a valid telegram is not received by the ACS255 within this time period, the drive will assume a loss of communications has occurred and react as selected below. Setting to zero disables the function.	1.0
	0.0...5.0 s		
<b>31 AUTOMATIC RESET</b>		Automatic fault reset. Automatic resets are possible only for certain fault types and when the automatic reset function is activated.	
3103	AUTO RESET TIME DELAY	Sets the delay time which will elapse between consecutive reset attempts when Auto Reset is enabled in Parameter <b>2108</b> START MODE SELECT / AUTOMATIC RESTART.	
	1...60 s		20 s

Parameters in the Long parameter mode			
Index	Name/Selection	Description	Def
<b>32 SUPERVISION</b>			
		Signal supervision. The drive monitors whether certain user selectable variables are within the user-defined limits. The user may set limits for speed, current etc. Supervision status can be monitored with relay output. See parameter group 14 RELAY OUTPUTS.	
3202	ADJUSTABLE THRESHOLD 1 LOWER LIMIT (ANALOG OUTPUT 1 / RELAY OUTPUT 1)	Used in conjunction with some settings of parameter <b>1501</b> ANALOG OUTPUT 1 (TERMINAL 8) FUNCTION SELECT & parameter <b>1401</b> USER RELAY 1 OUTPUT (TERMINALS 14, 15 & 16) FUNCTION SELECT.	0.0 %
	0.0 %... <b>3203</b>		
3203	ADJUSTABLE THRESHOLD 1 UPPER LIMIT (ANALOG OUTPUT 1 / RELAY OUTPUT 1)	Used in conjunction with some settings of parameter <b>1501</b> ANALOG OUTPUT 1 (TERMINAL 8) FUNCTION SELECT & parameter <b>1401</b> USER RELAY 1 OUTPUT (TERMINALS 14, 15 & 16) FUNCTION SELECT.	100.0 %
	<b>3202</b> ...200.0 %		
3205	ADJUSTABLE THRESHOLD 1 LOWER LIMIT (ANALOG OUTPUT 2 / RELAY OUTPUT 2)	Used in conjunction with some settings of Parameters <b>1507</b> ANALOG OUTPUT 2 (TERMINAL 11) FUNCTION SELECT & <b>1402</b> USER RELAY 2 OUTPUT (TERMINALS 17 & 18) FUNCTION SELECT.	0.0 %
	0.0... <b>3206</b>		
3206	ADJUSTABLE THRESHOLD 1 UPPER LIMIT (ANALOG OUTPUT 2 / RELAY OUTPUT 2)	Used in conjunction with some settings of Parameter <b>1507</b> ANALOG OUTPUT 2 (TERMINAL 11) FUNCTION SELECT & <b>1402</b> USER RELAY 2 OUTPUT (TERMINALS 17 & 18) FUNCTION SELECT.	100.0 %
	<b>3205</b> ...200.0%		
<b>33 INFORMATION</b>			
		Firmware update.	
3399	FIRMWARE UPGRADE	ABB Internal use only.	
<b>34 PANEL DISPLAY</b>			
		Selection of actual signals to be displayed on the drives front panel e.g. to display conveyer speed in feet per second based on the output frequency	
3400	DISPLAY SCALING FACTOR	Allow the user to display an alternative output unit scaled from an existing parameter. This function is disabled if set to 0.	0.000
	-30.000...30.000		
3405	DISPLAY SCALING SOURCE	If parameter <b>3400</b> DISPLAY SCALING FACTOR set >0, the variable selected in parameter <b>3405</b> DISPLAY SCALING SOURCE is multiplied by the factor entered in <b>3400</b> DISPLAY SCALING FACTOR, and displayed whilst the drive is running, with a 'c' to indicate the customer scaled units.	0
	0 : Motor Speed	Hertz/Rpm	
	1 : Motor Current	Ampere	
	2 : Analog Input 2	%	
<b>40 PROCESS PI SETUP</b>			
		Process PI control parameter set	
4001	PI PROPORTIONAL GAIN	PI Controller Proportional Gain. Higher values provide a greater change in the drive output frequency in response to small changes in the feedback signal. Too high a value can cause instability	1.0
	0.0...30.0		
4002	PI INTEGRAL TIME CONSTANT	PI Controller Integral Time. Larger values provide a more damped response for systems where the overall process responds slowly	1.0 s
	0.0...30.0 s		
4005	PI Operating Mode		0
	0 : DIRECT OPERATION	Use this mode if an increase in the motor speed should result in an increase in the feedback signal	
	1 : INVERSE OPERATION	Use this mode if an increase in the motor speed should result in a decrease in the feedback signal	
4010	PI Reference (Setpoint) Source Select	Selects the source for the PI Reference / Setpoint	0
	0	Digital Preset Setpoint. Parameter <b>4011</b> PI Digital Reference (Setpoint) is used	
	1	Analog Input 1 Setpoint	
	2	Analog Input 2 Setpoint	
4011	PI Digital Reference (Setpoint)	When parameter <b>4010</b> PI REFERENCE (SETPOINT) SOURCE SELECT = 0, this parameter sets the preset digital reference (setpoint) used for the PI Controller	0 %
	0.0...100.0 %		
4016	PI Feedback Signal Source Select		0
	0	Analog Input 2	
	1	Analog Input 1	

Parameters in the Long parameter mode			
Index	Name/Selection	Description	Def
<b>45 ENERGY METER RESET</b>			
4509	ENERGY CONSUMPTION (KWH) Meter Reset		
	0	No Function	0
	1	Setting to 1 resets internal kWh meter to zero (as displayed in parameter <b>0115</b> ENERGY CONSUMPTION KWH METER and parameter <b>0141</b> ENERGY CONSUMPTION MWH METER.	
<b>53 COMMUNICATIONS PARAMETERS</b>			
5302	DRIVE FIELDBUS ADDRESS	Sets the fieldbus address for the ACS255	1
	0...63		
5303	Modbus RTU Baud Rate	Sets the baud rate when Modbus RTU communications are used	115.2 kbps
	9.6...115.2 kbps		
5304	Modbus Data Format	Sets the expected Modbus telegram data format.	<b>n-1</b>
	<b>n-1</b>	No Parity, 1 stop bit	
	<b>n-2</b>	No parity, 2 stop bits	
	<b>0-1</b>	Odd parity, 1 stop bit	
	<b>E-1</b>	Even parity, 1 stop bit	
5305	CAN Open Baud Rate	Sets the baud rate when CAN Open communications are used	500 kbps
	125...1000 kbps		
<b>99 START-UP DATA</b>			
		Definition of motor set-up data.	
9902	Digital Inputs Function Select	Defines the function of the digital inputs depending on the control mode setting in Parameter <b>1103</b> PRIMARY COMMAND SOURCE MODE.	1
9903	Motor Control Mode	Selects the motor control method. An autotune must be performed if setting 0, 1 or 3 is used.	2: Speed Control (Enhanced V/F)
	0: Speed Control with Torque Limit (vector)		
	1: Torque Control with Speed Limit (vector)		
	2: Speed Control (Enhanced V/F)		
	3 : PM Vector		
	4 : Reserved		
9905	MOTOR RATED VOLTAGE	This parameter should be set to the rated (nameplate) voltage of the motor (Volts).	Drive Rating Dependent
	0...660V	Voltage <b>Note</b> : The stress on the motor insulation is always dependant on the drive supply voltage. This also applies in the case where the motor voltage rating is lower than the rating of the drive and the supply of the drive.	
9906	MOTOR RATED CURRENT	This parameter should be set to the rated (nameplate) current of the motor.	Drive Rating Dependent
	0.2* drive rated output current...1.0* drive rated output current	Current	
9907	MOTOR RATED FREQ	This parameter should be set to the rated (nameplate) frequency of the motor	60Hz
	25...500Hz	Frequency	
9908	MOTOR RATED SPEED	This parameter can optionally be set to the rated (nameplate) rpm of the motor. When set to the default value of zero, all speed related parameters are displayed in Hz, and the slip compensation for the motor is disabled. Entering the value from the motor nameplate enables the slip compensation function, and the ACS255 display will now show motor speed in estimated rpm. All speed related parameters, such as Minimum and Maximum Speed, Preset Speeds etc. will also be displayed in Rpm.	0 Rpm
	0...30000 Rpm		
9910	MOTOR PARAMETER AUTO-TUNE ENABLE	Drive measures the motor parameters for optimum control and efficiency. Following completion of the autotune.	0 : DISABLE
	0 : DISABLE		
	1: ENABLE	Drive immediately carries out a non-rotating autotune, parameter <b>9910</b> MOTOR PARAMETER AUTO-TUNE ENABLE returns to 0 when completed.	
9915	Motor Power Factor Cos $\phi$	When operating in Vector Speed or Vector Torque motor control modes, this parameter must be set to the motor nameplate power factor	-
	0.00...0.99		

Parameters in the Long parameter mode			
Index	Name/Selection	Description	Def
112	Vector mode advanced motor data	Only valid when parameter <b>9903</b> Motor Control Mode is 0,1, 3. <b>WARNING!</b> The following parameters are used internally by the drive to provide optimum possible motor control. Incorrect setting of the parameters can result in poor performance and unexpected behaviour of the motor. Adjustments should only be carried out by experienced users who fully understand the functions of the parameters.	
11201	MOTOR STATOR RESISTANCE (Rs)	Motor stator resistance value measured during the autotune.	-
11202	MOTOR ROTOR RESISTANCE (Rr)	Phase to phase rotor resistance value in ohms.	-
11203	MOTOR STATOR INDUCTANCE (Lsd)	For induction motors: phase stator inductance value.	-
11204	MOTOR MAGNETISING CURRENT (Id rms)	For induction motors: magnetizing / no load current. Before Auto-tune, this value is approximated to 60% of motor rated current (parameter <b>9906</b> MOTOR RATED CURRENT), assuming a motor power factor of 0.8.	-
11205	MOTOR LEAKAGE COEFFICIENT (Sigma)	Motor leakage inductance coefficient	-
11207	Quick Rs Measurement Enable	Allows the stator resistance parameter 11201 MOTOR STATOR RESISTANCE to be adapted during normal operation.	-
	0 : DISABLE		
	1 : ENABLE		
11208	MOTOR PARAMETER ADAPTATION ENABLE	Allows the stator inductance parameter 11203 MOTOR STATOR INDUCTANCE to be adapted during normal operation.	-
	0 : DISABLE		
	1 : ENABLE		
11209	PULSE WIDTH MINIMUM LIMIT	This parameter is used to limit the minimum output pulse width, which can be used for long cable applications. Increasing the value of this parameter will reduce the risk of over-current trips on long motor cables, but will also reduce the maximum available output motor voltage for a given input voltage.	-
	0...500		

## 9.5. Preventing un-authorized parameter editing.

This function can be used to prevent an un-authorized person from changing the drive parameter values; this function is disabled when delivered from the factory.

### Relevant Parameters

<b>1602</b>	Parameter Access Unlock
	0...65535
<b>1603</b>	Parameter Access code
	0...65535

### Locking Parameter Access

- 1) Go to Parameter **1603** (Long Parameter group) and enter in your chosen parameter access code.
- 2) Press the  button to exit and parameter **1603** will then be hidden and all parameters will be "Read only" (except for Parameter **1602** which will remain "Read Write").

### Unlocking Parameter Access

- 1) Enter into Parameter **1602** the same value as **1603** (as chosen in step 1 above).
- 2) All parameters will now be "Read Write" and parameter **1603** will become visible and show the value which was originally programmed as the parameter access code.
- 3) To disable this feature set parameter **1603** PARAMETER ACCESS CODE to zero and then **1602** PARAMETER ACCESS UNLOCK to zero.

## 10. Serial communications

### 10.1. RJ45 Connector Pin Assignment

ACS255 has an RJ45 connector on the front of the control panel. This connector allows the user to set up a drive network via a wired connection. The connector contains multiple interfaces for different communication protocols.

- PC and peripheral connection only
- Modbus RTU
- CANBus

The Remote keypad connection is always available, and can be used simultaneously with other interfaces, however only one other interface may be used, e.g. If Modbus RTU is in use, CAN is disabled.

The electrical signal arrangement of the RJ45 connector is shown as follows:

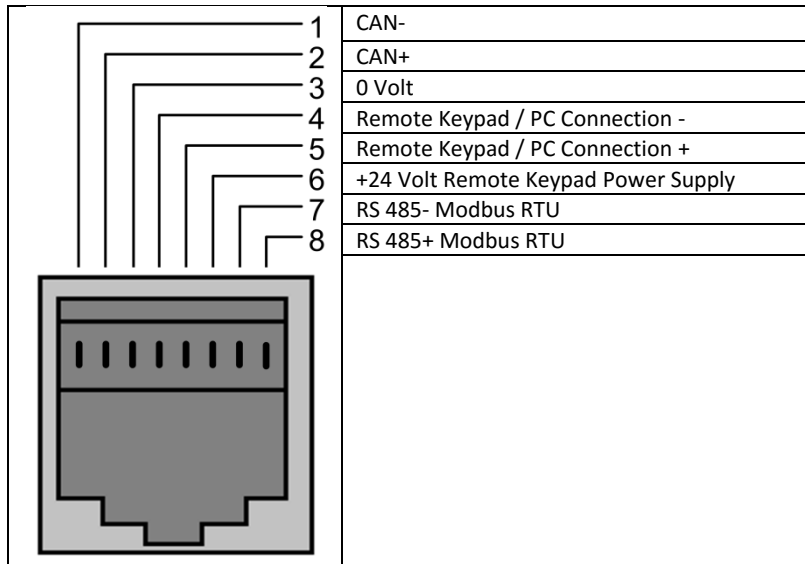

### 10.2. Modbus RTU Communications

#### 10.2.1. Modbus Telegram Structure

The ACS255 supports Master / Slave Modbus RTU communications, using the 03 Read Holding Registers and 06 Write Single Holding Register commands. Many Master devices treat the first Register address as Register 0; therefore it may be necessary to convert the Register Numbers detailed in section 10.2.4 by subtracting 1 to obtain the correct Register address. The telegram structure is as follows.

Command 03 – Read Holding Registers					
Master Telegram			Slave Response		
	Length			Length	
Slave Address	1	Byte	Slave Address	1	Byte
Function Code (03)	1	Byte	Function Code (03)	1	Byte
1 <sup>st</sup> Register Address	2	Bytes	Byte Count	1	Byte
No. Of Registers	2	Bytes	1 <sup>st</sup> Register Value	2	Bytes
CRC Checksum	2	Bytes	2 <sup>nd</sup> Register Value	2	Bytes
			Etc...		
			CRC Checksum	2	Bytes

Command 06 – Write Single Holding Register					
Master Telegram			Slave Response		
	Length			Length	
Slave Address	1	Byte	Slave Address	1	Byte
Function Code (06)	1	Byte	Function Code (06)	1	Byte
Register Address	2	Bytes	Register Address	2	Bytes
Value	2	Bytes	Register Value	2	Bytes
CRC Checksum	2	Bytes	CRC Checksum	2	Bytes

### 10.2.2. Modbus Control & Monitoring Registers

The following is a list of accessible Modbus Registers available in the ACS255.

- When Modbus RTU is configured as the Fieldbus option, all of the listed registers can be accessed.
- Registers 1 and 2 can be used to control the drive providing that Modbus RTU is selected as the primary command source (**1103** PRIMARY COMMAND SOURCE MODE = 4).
- Register 3 can be used to control the output torque level providing that
  - The drive is operating in Vector Speed or Vector Torque motor control modes (**9903** MOTOR CONTROL MODE = 1 or 2).
  - The torque controller reference / limit is set for 'Fieldbus' (**2014** TORQUE CONTROL REFERENCE / LIMIT SOURCE = 3).
- Register 4 can be used to control the acceleration and deceleration rate of the drive providing that Fieldbus Ramp Control is enabled (**2210** FIELDBUS RAMP CONTROL = 1).
- Registers 6 to 24 can be read regardless of the setting of parameter **1103** PRIMARY COMMAND SOURCE MODE.

Register Number	Upper Byte	Lower Byte	Read Write	Notes
1	Command Control Word		R/W	Command control word used to control the ACS255 when operating with Modbus RTU. The Control Word bit functions are as follows :- Bit 0 : Run/Stop command. Set to 1 to enable the drive. Set to 0 to stop the drive. Bit 1 : Fast stop request. Set to 1 to enable drive to stop with 2 <sup>nd</sup> deceleration ramp. Bit 2 : Reset request. Set to 1 in order to reset any active faults or trips on the drive. This bit must be reset to zero once the fault has been cleared. Bit 3 : Coast stop request. Set to 1 to issue a coast stop command.
2	Command Speed Reference		R/W	Setpoint must be sent to the drive in Hz to one decimal place, e.g. 500 = 50.0Hz
3	Command Torque Reference		R/W	Setpoint must be sent to the drive in % to one decimal place, e.g. 2000 = 200.0%
4	Command Ramp times		R/W	This register specifies the drive acceleration and deceleration ramp times used when Fieldbus Ramp Control is selected ( <b>2210</b> FIELDBUS RAMP CONTROL = 1) irrespective of the setting of <b>1103</b> PRIMARY COMMAND SOURCE MODE. The input data range is from 0 to 60000 (0.00s to 600.00s)
6	Error code	Drive status	R	This register contains 2 bytes. The Lower Byte contains an 8 bit drive status word as follows :- Bit 0 : 0 = Drive Disabled (Stopped), 1 = Drive Enabled (Running) Bit 1 : 0 = Drive Healthy, 1 = Drive Tripped The Upper Byte will contain the relevant fault number in the event of a drive trip. Refer to section 13.1 on page 62 for a list of fault codes and diagnostic information
7	Output Frequency		R	Output frequency of the drive to one decimal place, e.g.123 = 12.3 Hz
8	Output Current		R	Output current of the drive to one decimal place, e.g.105 = 10.5 Amps
9	Output Torque		R	Motor output torque level to one decimal place, e.g. 474 = 47.4 %
10	Output Power		R	Output power of the drive to two decimal places, e.g.1100 = 11.00 kW
11	Digital Input Status		R	Represents the status of the drive inputs where Bit 0 = Digital Input 1 etc.
20	Analog 1 Level		R	Analog Input 1 Applied Signal level in % to one decimal place, e.g. 1000 = 100.0%
21	Analog 2 Level		R	Analog Input 2 Applied Signal level in % to one decimal place, e.g. 1000 = 100.0%
22	Pre Ramp Speed Reference		R	Internal drive frequency setpoint
23	DC bus voltages		R	Measured DC Bus Voltage in Volts
24	Drive temperature		R	Measured Heatsink Temperature in °C

### 10.2.3. Modbus Parameter Access

All User Adjustable parameters are accessible by Modbus, except those that would directly affect the Modbus communications, e.g.

- **5302** DRIVE FIELDBUS ADDRESS
- **5303** Modbus RTU Baud Rate
- **5304** Modbus Data Format
- **5305** CAN Open Baud Rate

All parameter values can be read from the drive and written to, depending on the operating mode of the drive – some parameters cannot be changed whilst the drive is enabled for example.

When accessing a drive parameter via Modbus, the Register number for the parameter is in the order of the long parameter list (See page 43 with the first register being 129 (Parameter **0401** TRIP HISTORY LOG).

Modbus RTU supports sixteen bit integer values, hence where a decimal point is used in the drive parameter; the register value will be multiplied by a factor of ten,

E.g. Read Value of parameter **2008** = 500, therefore this is 50.0Hz.

For further details on communicating with ACS255 using Modbus RTU, please refer to your local ABB representative.



## 10.2.4. Modbus Parameter Register Map

Register No	Parameter No	Description
129	0401	TRIP HISTORY LOG
130	1100	KEYPAD MODE RESTART FUNCTION
131	1103	PRIMARY COMMAND SOURCE MODE
132	1202	PRESET / JOG FREQUENCY / SPEED 1
133	1203	PRESET / JOG FREQUENCY / SPEED 2
134	1204	PRESET / JOG FREQUENCY / SPEED 3
135	1205	PRESET / JOG FREQUENCY / SPEED 4
136	1300	ANALOG INPUT 1 SIGNAL FORMAT
137	1301	ANALOG INPUT 1 OFFSET
138	1302	ANALOG INPUT 1 SCALING
139	1304	ANALOG INPUT 2 SIGNAL FORMAT
140	1305	ANALOG INPUT 2 OFFSET
141	1307	ANALOG INPUT 2 SCALING
142	1401	OUTPUT RELAY 1 FUNCTION SELECT
143	1402	OUTPUT RELAY 2 FUNCTION SELECT
144	1404	RELAY OUTPUT HYSTERESIS CONTROL
145	1501	ANALOG OUTPUT 1 FUNCTION SELECT
146	1504	ANALOG OUTPUT 1 FORMAT
147	1507	ANALOG OUTPUT 2 FUNCTION SELECT
148	1508	ANALOG OUTPUT 2 FORMAT
149	1602	PARAMETER ACCESS UNLOCK
150	1603	PARAMETER ACCESS CODE DEFINITION
151	2005	OVER VOLTAGE CURRENT LIMIT
152	2006	MAINS LOS RIDE THROUGH/STOP CONTROL
152	2007	MINIMUM FREQUENCY / SPEED LIMIT
154	2008	MAXIMUM FREQUENCY / SPEED LIMIT
155	2014	TORQUE CONTROL REFERENCE/LIMIT SOURCE
156	2015	MINIMUM MOTORING TORQUE LIMIT
157	2017	MAXIMUM MOTORING TORQUE LIMIT/CURRENT LIMIT
158	2022	GENERATOR MODE MAX. TORQUE LIMIT (MAXIMUM REGENERATIVE TORQUE)
159	2101	SPIN START ENABLE
160	2102	STOP MODE
161	2103	V/F MODE MAGNETISING PERIOD
162	2106	DC INJECTION BRAKING VOLTAGE
163	2108	START MODE SELECT/AUTOMATIC RESTART
164	2110	LOW FREQUENCY TORQUE BOOST
165	2111	TORQUE BOOST FREQUENCY LIMIT
166	2112	ZERO SPEED HOLDING TIME
167	2202	ACCELERATION RAMP TIME
168	2203	DECELERATION RAMP TIME
169	2206	2ND DECELERATION RAMP TIME (FAST STOP)
170	2210	FIELD BUS RAMP CONTROL
171	2301	VECTOR SPEED CONTROLLER PROPORTIONAL GAIN
172	2302	VECTOR SPEED CONTROLLER INTEGRAL TIME CONSTANT
173	2303	VECTOR SPEED CONTROLLER D GAIN
174	2305	SYSTEM INERTIA CONSTANT
175	2500	SKIP FREQUENCY HYSTERESIS BAND
176	2501	SKIP FREQUENCY CENTRE POINT
177	2601	ENERGY OPTIMIZER
178	2603	V/F MODE VOLTAGE BOOST
179	2606	EFFECTIVE SWITCHING FREQUENCY
180	2607	AUTOMATIC THERMAL MANAGEMENT
181	2610	V/F CHARACTERISTIC ADJUSTMENT VOLTAGE
182	2611	V/F CHARACTERISTIC ADJUSTMENT FREQUENCY
183	3005	THERMAL OVERLOAD VALUE RETENTION
184	3018	COMMUNICATION LOSS ACTION
185	3019	COMMUNICATION LOSS TIMEOUT
186	3103	AUTO RESET TIME DELAY
187	3202	ADJUSTABLE THRESHOLD 1 LOWER LIMIT (ANALOG OUTPUT 1/RELAY OUTPUT 1)
188	3203	ADJUSTABLE THRESHOLD 1 UPPER LIMIT (ANALOG OUTPUT 1/RELAY OUTPUT 1)
189	3205	ADJUSTABLE THRESHOLD 1 LOWER LIMIT (ANALOG OUTPUT 1/RELAY OUTPUT 2)
190	3206	ADJUSTABLE THRESHOLD 1 UPPER LIMIT (ANALOG OUTPUT 1/RELAY OUTPUT 2)
191	3399	FIRMWARE UPGRADE (ABB INTERNAL USE ONLY)
192	3400	DISPLAY SPEED SCALING FACTOR
193	3405	DISPLAY SCALING SOURCE
194	4001	PI PROPORTIONAL GAIN
195	4002	PI INTEGRAL TIME CONSTANT
196	4005	PI OPERATING MODE
197	4010	PI REFERENCE (SETPOINT) SOURCE SELECT

Register No	Parameter No	Description
198	4011	PI DIGITAL REFERENCE (SETPOINT)
199	4016	PI FEEDBACK SIGNAL SOURCE SELECT
200	4509	ENERGY CONSUMPTION METER
201	5302	DRIVE FIELDBUS ADDRESS
202	5303	MODBUS RTU BAUD RATE
203	5304	MODBUS DATA FORMAT
204	5305	CANOPEN BAUD RATE
205	9902	DIGITAL INPUTS FUNCTION SELECT
206	9903	MOTOR CONTROL MODE
207	9905	MOTOR RATED VOLTAGE
208	9906	MOTOR RATED CURRENT
209	9907	MOTOR RATED FREQUENCY
210	9908	MOTOR RATED SPEED
211	9910	MOOTR PARAMETER AUTO-TUNE ENABLE
212	11201	MOTOR STATOR RESISTANCE
213	11202	MOTOR ROTOR RESISTANCE
214	11203	MOTOR STATOR INDUCTANCE
215	11204	MOTOR MAGNETISING CURRENT
216	11205	MOTOR LEAKAGE COEFFICIENT
217	11207	QUICK RS MEASUREMENT ENABLE
218	11208	MOOR PARAMETER ADAPTION ENABLE
219	11209	PULSE WIDTH MINIMUM LIMIT

## 11. Technical Data

### 11.1. Environmental

Ambient temperature range: Operational	: -10 ... 50 °C (Refer to section 11.5 for Derating Information)
Storage and Transportation	: -40 °C ... 60 °C
Max altitude for rated operation	: 1000m (Refer to section 11.5 for derating Information)
Relative Humidity	: < 95% (non condensing)
Note	: Drive must be Frost and moisture free at all times Installation above 2000m is not UL approved

### 11.2. Input/Output Current ratings and fuses

The following tables provide the output current rating information for the various ACS255 models. ABB Drives always recommend that selection of the correct ACS255 is based upon the motor full load *current* at the incoming supply voltage.

Cable dimensioning for nominal rated currents is shown in the table below together with the corresponding fuse types for short-circuit protection of the input power cable.

The rated fuse currents given in the table are the maximums for the mentioned fuse types. If smaller fuse ratings are used, check that the fuse rms current rating is larger than the nominal input current.

If 150% output power is needed, multiply nominal input current by 1.5.

**Check that the operating time of the fuse is below 0.5 seconds.** The operating time depends on the fuse type, the supply network impedance as well as the cross-sectional area, material and length of the supply cable. In case the 0.5 seconds operating time is exceeded with the gG or T fuses, ultra rapid (aR) fuses in most cases reduce the operating time to an acceptable level.

**Note:** Larger fuses must not be used when the input power cable is selected according to this table.

Model Number	Power (HP)	Nominal Input Current (A)	Nominal Input Current With 3% line choke (A)	Fuse (A)		Supply and PE Cable Size		Nominal Output Current (A)	Motor Cable Size		Maximum Motor Cable Length (Mtrs)	Recommended Brake Resistance (Ω)	Frame Size
				gG	UL Class CC or J	mm <sup>2</sup>	AWG		mm <sup>2</sup>	AWG			
ACS255-03U-02A1-6..	1	2.7	2.1	10	6	1.5	14	2.1	1.5	14	100	600	P2
ACS255-03U-03A1-6..	2	3.7	3.1	10	6	1.5	14	3.1	1.5	14	100	300	P2
ACS255-03U-04A1-6..	3	4.8	4.1	10	10	1.5	14	4.1	1.5	14	100	200	P2
ACS255-03U-06A5-6..	5	7.1	6.5	10	10	1.5	14	6.5	1.5	14	100	150	P2
ACS255-03U-09A0-6..	7.5	10.2	9.0	16	15	2.5	12	9	1.5	14	100	100	P2
ACS255-03U-12A0-6..	10	14.4	12	25	20	4	10	12	1.5	14	100	80	P3
ACS255-03U-17A0-6..	15	19.1	17	25	25	4	8	17	2.5	10	100	50	P3
ACS255-03U-22A0-6..	20	23.6	22	40	35	10	8	22	4	10	100	33	P3

#### Note

- Input current measurements are at 575VAC at drive nominal output current.
- Ratings shown above apply to 40°C Ambient temperature. For derating information, refer to section 11.5.1 on page 60.
- The maximum motor cable length stated applies to using a shielded motor cable. When using an unshielded cable, the maximum cable length limit may be increased by 50%. When using the ABB Drives recommended output choke, the maximum cable length may be increased by 100%
- The PWM output switching from any inverter when used with a long motor cable length can cause an increase in the voltage at the motor terminals, depending on the motor cable length and inductance. The rise time and peak voltage can affect the service life of the motor. ABB Drives recommend using an output choke for motor cable lengths of 50m or more to ensure good motor service life
- For UL compliant installation, use Copper wire with a minimum insulation temperature rating of 70°C, UL Class CC or Class J Fuses

### 11.3. Overload

The ACS255 can deliver 150% of the drive nominal output current for 60 seconds and 200 % for 3 seconds.

## 11.4. Additional Information for UL Approved Installations

ACS255 is designed to meet the UL requirements. In order to ensure full compliance, the following must be fully observed.

Input Power Supply Requirements				
Supply Voltage	500-600 Volts, + / - 10% variation allowed, Maximum 660 Volts RMS			
Imbalance	Maximum 3% voltage variation between phase – phase voltages allowed			
	All ACS255 units have phase imbalance monitoring. A phase imbalance of > 3% will result in the drive tripping. For input supplies which have supply imbalance greater than 3% (typically the Indian sub- continent & parts of Asia Pacific including China) ABB Drives recommends the installation of input line reactors. Alternatively.			
Frequency	50 – 60Hz + / - 5% Variation			
Short Circuit Capacity	<b>Voltage Rating</b>	<b>Min HP</b>	<b>Max HP</b>	<b>Maximum supply short-circuit current</b>
	600	1	20	100kA rms (AC)
	All the drives in the above table are suitable for use on a circuit capable of delivering not more than the above specified maximum short-circuit Amperes symmetrical with the specified maximum supply voltage.			
Incoming power supply connection must be according to section 5.9				
All ACS255 units are intended for indoor installation within controlled environments which meet the condition limits shown in section 11.1 on page 59.				
Branch circuit protection must be installed according to the relevant national codes. Fuse ratings and types are shown in section 11.2 on page 59.				
Suitable Power and motor cables should be selected according to the data shown in section 11.2 on page 59.				
Power cable connections and tightening torques are shown in section 4.4 on page 15.				
ACS255 provides motor overload protection in accordance with the National Electrical Code (US). <ul style="list-style-type: none"> <li>Where a motor thermistor is not fitted, or not utilised, Thermal Overload Memory Retention must be enabled by setting 3005 THERMAL OVERLOAD VALUE RETENTION = 1</li> <li>Where a motor thermistor is fitted and connected to the drive, connection must be carried out according to the information shown in section 5.7.2</li> </ul>				

## 11.5. Derating Information

Derating of the drive maximum continuous output current capacity is required when

- Operating at ambient temperature in excess of 40°C / 104°F
- Operating at Altitude in excess of 1000m / 3281 ft
- Operation with Effective Switching Frequency higher than the minimum setting

The following derating factors should be applied when operating drives outside of these conditions

### 11.5.1. Derating for Ambient Temperature

Enclosure Type	Maximum Temperature Without Derating. (UL Approved)	Derate by	Maximum Permissible Operating Ambient Temperature with Derating (Non UL Approved)
IP20	50°C / 122°F	N/A	50°C
IP66	40°C / 104°F	2.5% per °C (1.8°F)	50°C

### 11.5.2. Derating for Altitude

Enclosure Type	Maximum Altitude Without Derating	Derate by	Maximum Permissible (UL Approved)	Maximum Permissible (Non-UL Approved)
IP20	1000m / 3281ft	1% per 100m / 328 ft	2000m / 6562 ft	4000m / 13123 ft
IP66	1000m / 3281ft	1% per 100m / 328 ft	2000m / 6562 ft	4000m / 13123 ft

### 11.5.3. Derating for Switching Frequency

Enclosure Type	Switching Frequency (Where available)					
	4kHz	8kHz	12kHz	16kHz	24kHz	32kHz
IP20	N/A	N/A	20%	30%	40%	50%
IP66	N/A	10%	25%	35%	50%	50%

### 11.5.4. Example of applying Derating Factors

If a 5 HP IP66 drive is to be used at an altitude of 2000 metres above sea level, with 12kHz switching frequency and 45°C ambient temperature.

From the table above, we can see that the rated current of the drive is 9.5 Amps at 40°C,

Firstly, apply the switching frequency derating, 12kHz, 25% derating

$$9.5 \text{ Amps} \times 75\% = 7.1 \text{ Amps}$$

Now, apply the derating for higher ambient temperature, 2.5% per °C above 40°C = 5 x 2.5% = 12.5%

$$7.1 \text{ Amps} \times 87.5\% = 6.2 \text{ Amps}$$

Now apply the derating for altitude above 1000 metres, 1% per 100m above 1000m = 10 x 1% = 10%

$$7.9 \text{ Amps} \times 90\% = 5.5 \text{ Amps continuous current available.}$$

If the required motor current exceeds this level, it will be necessary to either:

- Reduce the switching frequency selected
- Use a higher power rated drive and repeat the calculation to ensure sufficient output current is available.

## 12. Appendix: Permanent magnet synchronous motors (PMSMs)

With PMSMs special attention must be paid on setting the motor nominal values correctly in parameter group 99 START-UP DATA. It is important that the nominal back-emf of the motor is available, further to ensure good performance a MOTOR PARAMETER AUTO-TUNE (**9910=1**) must be performed.



The following table lists the basic parameter settings needed for permanent magnet synchronous motors.

### 12.1.1. PMSM Motor nameplate data entry.

Action		Additional Information
<input type="checkbox"/> Enable PMSM motor control	Set <b>9903</b> to 3	
<input type="checkbox"/> Enter motor back-EMF voltage value	Enter Back EMF value into <b>9905</b>	The phase to phase value (at motor rated Speed) should be obtained from the motor nameplate or datasheet. If the voltage is given as a proportional value, such as 103V/1000 rpm in a 3000rpm motor, set 309V here. Sometimes the value is given as the peak value. In this case divide the value by the square root of 2 (1.41). <b>Note:</b> Incorrect value can result in abnormal motor operation (motor vibration)
<input type="checkbox"/> Enter Motor Rated Current	Enter value into <b>9906</b>	Obtained from Motor nameplate (Amps).
<input type="checkbox"/> Enter Motor Rated Frequency	Enter value into <b>9907</b>	<b>Note :</b> The drive uses <b>9907</b> to calculate the number of motor pole pairs. Frequency (Hz) = speed (rpm) x (number of pole pairs) / 60
<input type="checkbox"/> Enter Motor Rated Speed	Enter value into <b>9908</b>	Obtained from Motor nameplate (rpm) Speed (rpm) = frequency (Hz) x 60 / (number of pole pairs)
<input type="checkbox"/> Set Motor Switching Frequency	Set <b>2606</b> to 16kHz	16kHz provides optimum motor control.
<input type="checkbox"/> Set Motor boost values	Set <b>2110</b> to 25%	Boost Current Level
	Set <b>2111</b> to 10%	Boost Frequency

### 12.1.2. PMSM Motor Auto-tune.

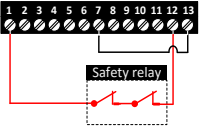
A Motor Auto-tune must be carried out in order to measure the motor electrical characteristics, during the Auto-tune test brakes will be applied by the drive (unless controlled by other means).

Action		Additional Information
<input type="checkbox"/> Close Safe Torque off input connections		Drive should now show <b>Stop</b>
<input type="checkbox"/> Enable Motor Auto-tune	Set <b>9910</b> to a <u>1</u> and press the 	The display will show <b>Auto-t</b> . (Test procedure may take several minutes to complete). Once the Auto-tune is completed <b>9910</b> will return to 0 and the display will show <b>Stop</b> . <b>Note:</b> Motor Auto-tune will need to be repeated if the motor, motor cables, motor parameters or drive control mode is changed in <b>9903</b> .

### 12.1.3. Troubleshooting

Observation	Action
Rotor not orientating on start up	Increase <b>2103</b> (Current Magnetising time)
Long delay following Rotor orientation on start up	Decrease <b>2103</b> (Current Magnetising time)
Poor torque performance at low speed	Increase value in <b>2110</b> (Boost current level) and <b>2111</b> (Torque boost frequency limit) Suitable starting values are 25% ( <b>2110</b> ) and 10% ( <b>2111</b> )
Motor Vibration/ $\overline{I}$ trips/Cogging at low speed	Check correct settings of motor nameplate data. Check correct value of <b>9905</b> (Motor Back EMF voltage). Reduce value of <b>2301</b> (Vector Speed Gain)(As much as 50% reduction in some instances)
$I_{t-trP}$	Check correct settings of motor nameplate data. Check correct value of <b>9905</b> (Motor Back EMF voltage). Check Correct setting of <b>2110</b> and <b>2111</b> .
	Care should be taken not to apply to high of a value in <b>2110</b> and <b>2111</b> as excess motor heating may result.

## 13.Troubleshooting

### 13.1. Fault messages

Fault Code	No.	Description	Corrective Action
<b>no-FLt</b>	00	No Fault	Displayed in Parameter <b>0401</b> if no faults are recorded in the log
<b>0l-b</b>	01	Brake channel over current	Ensure the connected brake resistor is above the minimum permissible level for the drive – refer to the ratings shown in section 11.2. Check the brake resistor and wiring for possible short circuits.
<b>0L-br</b>	02	Brake resistor overload	The drive software has determined that the brake resistor is overloaded, and trips to protect the resistor. Always ensure the brake resistor is being operated within its designed parameter before making any parameter or system changes. To reduce the load on the resistor, increase deceleration the time, reduce the load inertia or add further brake resistors in parallel, observing the minimum resistance value for the drive in use.
<b>F0001</b>	03	Instantaneous over current on drive output. Excess load on the motor.	<b>Fault Occurs on Drive Enable</b> Check the motor and motor connection cable for phase – phase and phase – earth short circuits. Check the load mechanically for a jam, blockage or stalled condition Ensure the motor nameplate parameters are correctly entered in parameter <b>9905, 9906, and 9907</b> . If operating in Vector mode (Parameter <b>9903</b> – 0 or 1), also check the motor power factor in parameter <b>9915</b> and ensure an autotune has been successfully completed for the connected motor. Reduced the Boost voltage setting in parameter <b>2603</b> Increase the ramp up time in parameter <b>2202</b> If the connected motor has a holding brake, ensure the brake is correctly connected and controlled, and is releasing correctly <b>Fault Occurs When Running</b> If operating in Vector mode (parameter <b>9903</b> – 0,1,3), reduce the speed loop gain in parameter <b>2301</b>
<b>F0009</b>	04	Drive has tripped on overload after delivering >100% of value in parameter <b>9906</b> for a period of time.	Check to see when the decimal points are flashing (drive in overload) and either increase acceleration rate or reduce the load. Check motor cable length is within the limit specified for the relevant drive in section 10.2 Ensure the motor nameplate parameters are correctly entered in parameter <b>9905, 9906, and 9907</b> . If operating in Vector mode (Parameter <b>9903</b> – 0 or 1), also check the motor power factor in parameter <b>9915</b> and ensure an autotune has been successfully completed for the connected motor. Check the load mechanically to ensure it is free, and that no jams, blockages or other mechanical faults exist
<b>F0004</b>	05	Hardware Over Current	Check the wiring to motor and the motor for phase to phase and phase to earth short circuits. Disconnect the motor and motor cable and retest. If the drive trips with no motor connected, it must be replaced and the system fully checked and retested before a replacement unit is installed.
<b>F0002</b>	06	Over voltage on DC bus	The value of the DC Bus Voltage can be displayed in parameter <b>0107</b> A historical log is stored at 256ms intervals prior to a trip in parameter <b>0191</b> This fault is generally caused by excessive regenerative energy being transferred from the load back to the drive. When a high inertia or over hauling type load is connected. If the fault occurs on stopping or during deceleration, increase the deceleration ramp time <b>2203</b> or connect a suitable brake resistor to the drive. If operating in Vector Mode, reduce the speed loop gain in parameter <b>2301</b>
<b>F0006</b>	07	Under voltage on DC bus	This occurs routinely when power is switched off. If it occurs during running, check the incoming supply voltage, and all connections into the drive, fuses, contactors etc.
<b>0-t</b>	08	Heatsink over temperature	The heatsink temperature can be displayed in parameter <b>0110</b> . A historical log is stored at 30 second intervals prior to a trip in parameter <b>0193</b> Check the drive ambient temperature Ensure the drive internal cooling fan is operating Ensure that the required space around the drive as shown in sections 0 on page 17 has been observed, and that the cooling airflow path to and from the drive is not restricted Reduce the effective switching frequency setting in parameter <b>2606</b> Reduce the load on the motor / drive
<b>U-t</b>	09	Under temperature	Trip occurs when ambient temperature is less than -10°C. The temperature must be raised over -10°C in order to start the drive.
<b>P-def</b>	10	Factory Default parameters have been loaded	Press STOP key, the drive is now ready to be configured for the required application
<b>F0014</b>	11	External trip	E-trip requested on control input terminals. Some settings of parameter <b>9902</b> require a normally closed contactor to provide an external means of tripping the drive in the event that an external device develops a fault. If a motor thermistor is connected check if the motor is too hot.
<b>F0010</b>	12	Communications Fault	Communications lost with PC or remote keypad. Check the cables and connections to external devices

Fault Code	No.	Description	Corrective Action
<b>F<sub>LT-dc</sub></b>	13	Excessive DC Ripple	The DC Bus Ripple Voltage level can be displayed in parameter <b>0187</b> A historical log is stored at 20ms intervals prior to a trip in parameter <b>0194</b> Check all three supply phases are present and within the 3% supply voltage level imbalance tolerance. Reduce the motor load If the fault persists, contact your local ABB Drives Sales Partner
<b>F0022</b>	14	Input phase loss trip	Drive intended for use with a 3 phase supply, one input phase has been disconnected or lost.
<b>h<sub>0-1</sub></b>	15	Instantaneous over current on drive output.	Refer to fault 3 above
<b>F0018</b>	16	Faulty thermistor on heatsink.	Refer to your ABB Sales Partner.
<b>F0027</b>	17	Internal memory fault.	Parameters not saved, defaults reloaded. Try again. If problem recurs, refer to your ABB Authorised Distributor.
<b>F0007</b>	18	4-20mA Signal Lost	The reference signal on Analog Input 1 or 2 (Terminals 6 or 10) has dropped below the minimum threshold of 3mA. Check the signal source and wiring to the ACS255 terminals.
<b>dR<sub>LA-E</sub></b>	19	Internal memory fault.	Parameters not saved, defaults reloaded. Try again. If problem recurs, refer to your ABB Authorised Distributor.
<b>F-P<sub>tc</sub></b>	21	Motor PTC Over Temperature	The connected motor PTC device has caused the drive to trip
<b>F<sub>Rn-F</sub></b>	22	Cooling Fan Fault	Check and if necessary, replace the drive internal cooling fan
<b>F0003</b>	23	Ambient Temperature too High	The measured temperature around the drive is above the operating limit of the drive. Ensure the drive internal cooling fan is operating Ensure that the required space around the drive as shown in section 4.5 and 4.7 has been observed, and that the cooling airflow path to and from the drive is not restricted Increase the cooling airflow to the drive Reduce the effective switching frequency setting in parameter <b>2606</b> . Reduce the load on the motor / drive
<b>O-<sub>tor9</sub></b>	24	Maximum Torque Limit Exceeded	The output torque limit has exceeded the drive capacity or trip threshold Reduce the motor load, or increase the acceleration time
<b>OU<sub>t-F</sub></b>	26	Drive output fault	Drive output fault
<b>St<sub>o-F</sub></b>	29	Internal STO circuit Error	Refer to your ABB Sales Partner
<b>R<sub>tF-01</sub></b>	40	Autotune Failed	Measured motor stator resistance varies between phases. Ensure the motor is correctly connected and free from faults. Check the windings for correct resistance and balance.
<b>R<sub>tF-02</sub></b>	41		Measured motor stator resistance is too large. Ensure the motor is correctly connected and free from faults. Check that the power rating corresponds to the power rating of the connected drive.
<b>R<sub>tF-03</sub></b>	42		Measured motor inductance is too low. Ensure the motor is correctly connected and free from faults.
<b>R<sub>tF-04</sub></b>	43		Measured motor inductance is too large. Ensure the motor is correctly connected and free from faults. Check that the power rating corresponds to the power rating of the connected drive.
<b>R<sub>tF-05</sub></b>	44		Measured motor parameters are not convergent. Ensure the motor is correctly connected and free from faults. Check that the power rating corresponds to the power rating of the connected drive.
<b>OU<sub>t-Ph</sub></b>	49	Output (Motor) Phase Loss	One of the motor output phases is not connected to the drive.
<b>S<sub>c-F01</sub></b>	50	Modbus comms fault	A valid Modbus telegram has not been received within the watchdog time limit set in parameter <b>3018</b> . Check the network master / PLC is still operating Check the connection cables Increase the value of parameter <b>3019</b> to a suitable level
<b>S<sub>c-F02</sub></b>	51	CAN Open comms trip	A valid CAN open telegram has not been received within the watchdog time limit set in parameter <b>3018</b> Check the network master / PLC is still operating Check the connection cables Increase the value of parameter <b>3018</b> to a suitable level
<b>S<sub>c-F04</sub></b>	53	IO card comms trip	Internal communication to the inserted Option Module has been lost. Check the module is correctly inserted

## Contact us

**ABB Oy**

AC Drives  
P.O. Box 184  
FI-00381 HELSINKI  
FINLAND  
Telephone +358 10 22 11  
Fax: +358 10 22 22681  
[www.abb.com/drives](http://www.abb.com/drives)

**ABB Inc.**

Automation Technologies  
Drives & Motors  
16250 West Glendale Drive  
New Berlin, WI 53151  
USA  
Telephone 262 785-3200  
1-800-HELP-365  
Fax: 262 780-5135  
[www.abb.us/drives](http://www.abb.us/drives)

**Canada Headquarters, Low  
Voltage Drives****ABB Inc.**

Low Voltage Drives  
2117, 32nd Avenue  
Lachine, Quebec H8T 3J1  
Tel(Drives): (800) 215-3006  
Tel(General): (800) 567-0283  
Fax: (514) 420-3137  
[www.abb.ca/drives](http://www.abb.ca/drives)



3AXD10000528265

3AXD10000528265 Rev A (EN) 2016-09-13