

ABB industrial drives

Firmware manual

ACS880 diode supply control program



Power and productivity
for a better world™



List of related manuals

General manuals	Code (English)
<i>Safety instructions for ACS880 multidrive cabinets and modules</i>	3AUA0000102301
<i>Safety instructions for ACS880 liquid-cooled multidrive cabinets and modules</i>	3AXD50000048633
<i>Electrical planning instructions for ACS880 multidrive cabinets and modules</i>	3AUA0000102324
<i>Electrical planning instructions for ACS880 liquid-cooled multidrive modules</i>	3AXD50000048634
<i>Mechanical installation instructions for ACS880 multidrive cabinets</i>	3AUA0000101764
<i>Cabinet design and construction instructions for ACS880 air-cooled and liquid-cooled multidrive modules</i>	3AUA0000107668
Inverter module manuals and guides	
<i>ACS880-104 inverter modules hardware manual</i>	3AUA0000104271
<i>ACS880-104LC inverter modules hardware manual</i>	3AXD50000045610
<i>ACS880 primary control program firmware manual</i>	3AUA0000085967
<i>ACS880 primary control program quick start-up guide</i>	3AUA0000098062
Supply module manuals	
<i>ACS880-204 IGBT supply modules hardware manual</i>	3AUA0000131525
<i>ACS880 IGBT supply control program firmware manual</i>	3AUA0000131562
<i>ACS880-304 +A003 diode supply modules hardware manual</i>	3AUA0000102452
<i>ACS880-304 +A018 diode supply modules hardware manual</i>	3AXD50000010104
<i>ACS880-304LC+A019 diode supply modules hardware manual</i>	3AXD50000045157
<i>ACS880 diode supply control program firmware manual</i>	3AUA0000103295
<i>ACS880 distributed I/O bus supplement</i>	3AXD50000126880
<i>ACS880-904 regenerative rectifier modules hardware manual</i>	3AXD50000020457
<i>ACS880 regenerative rectifier control program firmware manual</i>	3AXD50000020827
Brake module and DC/DC converter module manuals	
<i>ACS880-604 1-phase brake chopper units as modules hardware manual</i>	3AUA0000106244
<i>ACS880-604 3-phase brake modules hardware manual</i>	3AXD50000022033
<i>ACS880 brake control program firmware manual</i>	3AXD50000020967
<i>ACS880-1604 DC/DC converter modules hardware manual</i>	3AXD50000023642
<i>ACS880 DC/DC converter control program firmware manual</i>	3AXD50000024671
Cabinet-installed multidrive manuals	
<i>ACS880-107 inverter units hardware manual</i>	3AUA0000102519
<i>ACS880-207 IGBT supply units hardware manual</i>	3AUA0000130644
<i>ACS880-307 (+A003) diode supply units hardware manual</i>	3AUA0000102453
<i>ACS880-307 +A018 diode supply units hardware manual</i>	3AXD50000011408
<i>ACS880-607 1-phase brake units hardware manual</i>	3AUA0000102559
<i>ACS880-607 3-phase brake units hardware manual</i>	3AXD50000022034
<i>ACS880-907 regenerative rectifier units hardware manual</i>	3AXD50000020546
<i>ACS880-1607 DC/DC converter units hardware manual</i>	3AXD50000023644
Option manuals and guides	
<i>ACX-AP-x assistant control panels user's manual</i>	3AUA0000085685

You can find manuals and other product documents in PDF format on the Internet. See section [Document library on the Internet](#) on the inside of the back cover. For manuals not available in the Document library, contact your local ABB representative.

Firmware manual

ACS880 diode supply control program

Table of contents



2. Start-up



Table of contents

1. Introduction to the manual

What this chapter contains	9
Applicability	9
Safety instructions	10
Target audience	10
Contents of the manual	10
Related documents	10
Terms and abbreviations	11
Cybersecurity disclaimer	12

2. Start-up

3. Using the control panel

4. Program features

What this chapter contains	17
Overview of the control program	17
DxD module	17
DxT module	18
Programming via parameters	19
Control locations for start/stop	19
Local control vs. external control	19
External control	19
Local control	20
Run enable, Start/stop and Start enable control	20
Settings and diagnostics	20
Additional settings and diagnostics for DxT modules	21
Application programming	21
Control interfaces	21
Programmable analog inputs	21
Settings	21
Programmable analog outputs	21
Settings	21
Programmable digital inputs and outputs	22
Settings	22
Programmable relay outputs	22
Settings	22
Programmable I/O extensions	22
Settings	23
Fieldbus control	23
Settings	23
External controller interface	24
General	24
Topology	24
Communication	24
Settings	25



DDCS communication with inverter unit	26
Settings and diagnostics	26
Data storage parameters	26
Settings	26
Programmable protection functions	27
External events (parameters 131.01 ... 131.10)	27
Local control loss detection (parameter 149.05)	27
Earth leakage fault source selection (parameter 131.28)	27
External earth leakage action selection (parameter 131.29)	27
Fuse trip fault source (parameter 131.38)	27
Brake chopper fault source (parameter 131.39)	27
Counting the number of charging attempts (DxD modules only)	27
Settings and diagnostics	27
Automatic fault resets	27
Settings	27
Optional overvoltage and undervoltage protections of DxD module	28
Settings and diagnostics	28
Temperature supervision	28
Settings and diagnostics	28
Additional settings and diagnostics for DxT modules	29
Maintenance timers and counters	29
Settings	29
Load analyzer	30
Peak value logger	30
Amplitude loggers	30
Settings	30
Default I/O connection diagram for DxD modules (ZCU)	31
Default I/O connection diagram for DxT modules (BCU)	33
Charging of DxD supply unit	35
Settings and diagnostics	36
Charging of DxT supply unit	37
Settings and diagnostics	37
Reduced run function	38
6-pulse diode supply unit	38
12-pulse diode supply unit	38
Activation of the reduced run function	39
Settings and diagnostics	39
User lock	40
Settings	40

5. Parameters

What this chapter contains	41
Terms and abbreviations	41
Reserved digital inputs and relay outputs	42
Summary of parameter groups	42
Parameter listing	44
101 Actual values	44
104 Warnings and faults	45
105 Diagnostics	46
106 Control and status words	47
107 System info	53
110 Standard DI, RO	53
111 Standard DIO, FI, FO	58



112 Standard AI	60
113 Standard AO	63
114 Extension I/O module 1	66
115 Extension I/O module 2	81
116 Extension I/O module 3	85
119 Operation mode	88
120 Start/stop	89
121 Start/stop mode	94
131 Fault functions	94
133 Generic timer & counter	101
136 Load analyzer	106
147 Data storage	109
149 Panel port communication	110
150 FBA	111
151 FBA A settings	114
152 FBA A data in	116
153 FBA A data out	116
154 FBA B settings	116
155 FBA B data in	117
156 FBA B data out	118
160 DDCS communication	118
161 DDCS transmit	119
162 DDCS receive	123
190 Additional actual values	126
192 Additional actual values 2	127
195 HW configuration	128
196 System	131
206 I/O bus configuration	135
207 I/O bus service	135
208 I/O bus diagnostics	135
209 I/O bus fan identification	135

6. Additional parameter data

What this chapter contains	137
Terms and abbreviations	137
Fieldbus addresses	138
Parameter groups 101...107	139
Parameter groups 110...209	141

7. Fault tracing

What this chapter contains	159
Safety	159
Indications	160
Warnings and faults	160
Editable messages	160
Warning/fault history and analysis	160
Event logs	160
Auxiliary codes	160
Factory data logger	160
Other data loggers	161
User data logger	161
PSL2 data logger	161



Parameters that contain warning/fault information	161
Warning messages	162
Fault messages	170

8. Fieldbus control through a fieldbus adapter

What this chapter contains	181
System overview	182
Basics of the fieldbus control interface	183
Control word and Status word	183
Actual values	183
Contents of the fieldbus Control word	184
Contents of the fieldbus Status word	186
The state diagram	187
Setting up the diode supply unit for fieldbus control	188
Setting up the communication between DSU and inverter unit	189

9. Drive-to-drive link

Further information

Product and service inquiries	193
Product training	193
Providing feedback on ABB manuals	193
Document library on the Internet	193



1

Introduction to the manual

What this chapter contains

This chapter describes the contents of the manual. It also contains information on the compatibility, safety and intended audience.

Applicability

This manual applies to the ACS880 diode supply control program (ADILX v2.5x or later).

There are three kinds of ACS880 diode supply modules:

1. ACS880-304 +A003 is an air-cooled diode-diode module which is equipped with six diodes. The DC busbar of the module is charged through charging resistors. The resistors are located inside the inverter modules or in an external charging circuit controlled by the control unit.
2. ACS880-304LC +A019 is a liquid-cooled diode-diode module which is equipped with six diodes. Charging is similar to ACS880-304 +A003.
3. ACS880-304 +A018 is an air-cooled, half-controlled diode-thyristor module which is equipped with three thyristors in upper legs and three diodes in lower legs of the six pulse bridge. The DC busbar of the module is charged by decreasing the firing angle of the thyristors. ACS880-304 +A018 modules can also be connected parallel if more power is needed.

The control program described in this manual is used with cabinet-installed diode supply unit of types ACS880-307 / ACS880-307LC, diode supply module of types ACS880-304 / ACS880-304LC, and the diode supply unit included in drive of types ACS880-07 / ACS880-07CLC.

Safety instructions

Follow all safety instructions delivered with the supply unit.

- Read the **complete safety instructions** before you install, commission, use or service the supply unit. The complete safety instructions are given in the *Hardware manual* of your supply unit and in *Safety instructions for ACS880 multidrive cabinets and modules* (3AUA0000102301 [English]) for air-cooled modules, and in *Safety instructions for ACS880 liquid-cooled multidrive cabinets and modules* (3AXD50000048633 [English]) for liquid-cooled modules.
- Read the **software function specific warnings and notes** before changing the default settings of the function. For each function, the warnings and notes are given in the section describing the related user-adjustable parameters.
- Read **task specific safety instructions** before starting the task. See the section describing the task.

Target audience

This manual is intended for people who operate, commission, set parameters, monitor or troubleshoot diode supply units and modules. The reader is expected to know the fundamentals of electricity, wiring, electrical components and electrical schematic symbols.

Contents of the manual

The chapters of this manual are briefly described below.

Start-up refers to where the start-up procedure of the supply unit is described.

Using the control panel provides the basic instructions for use of the control panel.

Program features describes the program features of the diode supply control program.

Parameters lists the parameters of the diode supply control program.

Additional parameter data contains more information on the parameters.

Fault tracing lists all alarm and fault messages including possible causes and corrective actions.

Fieldbus control through a fieldbus adapter describes how the diode supply unit can be controlled by external devices over a communication network.

Drive-to-drive link describes the communication between drives connected together by the drive-to-drive (D2D) link.

Related documents

See *List of related manuals* on the inside of the front cover.

Terms and abbreviations

Term/abbreviation	Definition
ACS-AP-I	Types of control panel used with ACS880 drives
ACS-AP-W	
AI	Analog input; interface for analog input signals
AO	Analog output; interface for analog output signals
BCU	Type of a control unit used in ACS880 drives that consists of a BCON board built into a metal housing. BCU control unit is used with <i>DxT</i> diode supply modules.
DC link	DC circuit between rectifier and inverter
DDCS	Distributed drives communication system; a protocol used in optical fiber communication
DI	Digital input; interface for digital input signals
DIO	Digital input/output; interface that can be used as a digital input or output
Diode supply module	Diode (or diode-thyristor) rectifier and related components enclosed inside a metal frame or enclosure. Intended for cabinet installation.
Diode supply unit	Diode supply modules under control of one control board, and related components. See <i>Diode supply module</i> .
DSU	<i>Diode supply unit</i>
DxD	Diode supply module with uncontrolled six pulse diode bridge
DxT	Diode supply module with half-controlled six pulse diode-thyristor bridge
EFB	Embedded fieldbus
FAIO-01	Optional analog I/O extension module
FBA	Fieldbus adapter
FIO-01	Optional digital I/O extension module
FIO-11	Optional analog I/O extension module
FCAN-0x	Optional CANopen® adapter
FCNA-0x	Optional ControlNet™ adapter
FDCO-0x	Optional DDCS communication module
FDIO-01	Optional digital I/O extension module
FDNA-0x	Optional DeviceNet™ adapter
FEA-03	Optional I/O extension adapter
FECA-01	Optional EtherCAT® adapter
FENA-11	Optional EtherNet/IP™, Modbus/TCP® and PROFINET IO® adapter
FENA-21	Optional dual-port EtherNet/IP, Modbus/TCP and PROFINET IO adapter
FEPL-0x	Optional Ethernet POWERLINK adapter
FPBA-0x	Optional PROFIBUS DP® adapter
FSCA-0x	Optional Modbus® adapter
I/O	Input/Output
MCB	Main circuit breaker
Parameter	User-adjustable operation instruction to the diode supply unit, or signal measured or calculated by the diode supply unit
PLC	Programmable logic controller
RDCO	Optional DDCS communication module used with <i>BCU</i> control unit
RO	Relay output; interface for a digital output signal. Implemented with a relay.
STO	Safe torque off
ZCU	Type of control unit used in ACS880 drives that consists of a ZCON board built into a plastic housing. ZCU control unit is used with <i>DxD</i> diode supply modules.

Cybersecurity disclaimer

This product is designed to be connected to and to communicate information and data via a network interface. It is Customer's sole responsibility to provide and continuously ensure a secure connection between the product and Customer network or any other network (as the case may be). Customer shall establish and maintain any appropriate measures (such as but not limited to the installation of firewalls, application of authentication measures, encryption of data, installation of anti-virus programs, etc) to protect the product, the network, its system and the interface against any kind of security breaches, unauthorized access, interference, intrusion, leakage and/or theft of data or information. ABB and its affiliates are not liable for damages and/or losses related to such security breaches, any unauthorized access, interference, intrusion, leakage and/or theft of data or information.

See also section [User lock](#) (page 40).

2

Start-up

In case of DxT diode supply module, the user needs to set the parameter [195.01 Supply voltage](#) before start-up. In case of DxD diode supply module, the parameter [195.01 Supply voltage](#) must be set only if optional charging resistor control is used. See the appropriate supply unit hardware manual, or drive hardware manual for the hardware-related tasks to be done at the start-up.

If the supply unit consists of more than one DxT diode supply module, set parameters [195.30 Parallel type list filter](#) and [195.31 Parallel connection rating id](#). Save the settings with parameter [196.07 Parameter save manually](#), and reboot the control unit with parameter [196.08 Control board boot](#).

If the supply unit is equipped with an optional fieldbus adapter, the commission engineer must check and tune the related parameters at start-up. See chapter [Fieldbus control through a fieldbus adapter](#).







3

Using the control panel

Refer to *ACS-AP-x assistant control panels user's manual* (3AUA0000085685 [English]).

4

Program features

What this chapter contains

This chapter describes the features and I/O interface of the diode supply control program.

Overview of the control program

ACS880 diode supply control program can be used to control either DxD supply module (air-cooled module of type ACS880-304 +A003, and liquid-cooled module of type ACS880-304LC +A019), or DxT supply module (air-cooled module of type ACS880-304 +A018).

■ DxD module

The control program of diode-diode module runs on a ZCU control unit. The control of the DxD supply unit is simple. The DxD module does not need any control pulses but it operates automatically whenever the bridge is connected to the input power line. Thus the primary function of the program is the main contactor on/off control. In addition, the control program protects the unit against overtemperature, DC overvoltage and DC undervoltage. If there is an external DC link charging circuit, the control program controls the charging circuit on and off at the power up. DC voltage protections are applicable only when the optional DC voltage measurement function is used. See section [Optional overvoltage and undervoltage protections of DxD module](#) on page 28.

■ DxT module

The control program of diode-thyristor module runs on a BCU control unit. The control program controls the main contactor or breaker and the firing pulses of the thyristors. The control program can control:

- 6-pulse diode supply unit with one or parallel-connected DxT modules
- 12-pulse diode supply unit with two or more DxT modules.

In 6-pulse parallel-connected diode supply unit, all modules have equal firing pulses for the thyristors. In 12-pulse diode supply unit, there is 30 degree difference between the firing pulses for different windings, because 12-pulse transformer has 30 degree phase shift between windings.

After start command, the control program closes the main contactor or breaker (MCB) and controls the DC link charging by controlling the thyristor firing angle. Thus there is no need for separate charging circuit. When the DC link is charged, the thyristors are fired with 120 degrees pulses and the bridge is in diode mode.

There are, for example, following additional measurements compared to DxD module:

- phase currents,
- DC voltage,
- grid main voltages,
- module temperature measurement,
- ambient temperature measurement.

There are following additional protections compared to DxD module:

- DC busbar short circuit,
- overcurrent,
- grid overvoltage,
- grid undervoltage,
- phase lost,
- DC busbar undervoltage,
- current asymmetry,
- thyristor overtemperature,
- module overtemperature.

There are following additional protections in parallel-connected DxT modules:

- phase current difference between parallel modules,
- DC voltage difference between parallel modules,
- grid main voltage difference between parallel modules,
- monitoring of temperature difference between parallel modules.

There are following additional protections in 12-pulse diode supply unit:

- total current difference of the DC busbar between the modules connected to different windings of 12-pulse transformer,
 - monitoring of running status difference between the modules for each windings.
-

Programming via parameters

Parameters can be set via

- the control panel, as described in chapter [Using the control panel](#)
- the Drive composer PC tool, or
- the fieldbus interface, as described in chapter [Fieldbus control through a fieldbus adapter](#).

All parameter settings are stored automatically to the permanent memory of the diode supply unit. However, if an internal +24 V DC power supply is used for the control unit, it is highly recommended to force a save by using parameter [196.07 Parameter save manually](#) before powering down the control unit after any parameter changes.

If necessary, the default parameter values can be restored by parameter [196.06 Parameter restore](#).

Control locations for start/stop

■ Local control vs. external control

The ACS880 has two main control locations: external and local. The control location is selected with the Loc/Rem key on the control panel or in the PC tool.

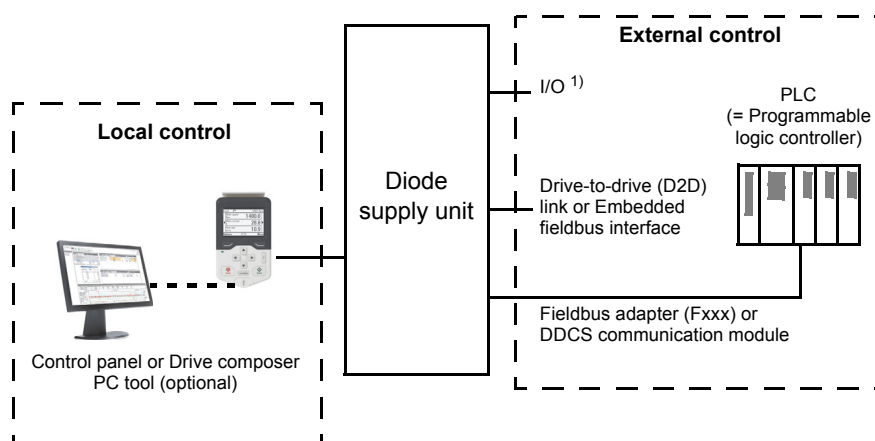

1) Extra inputs/outputs can be added by installing optional I/O extension modules (FIO-xx) in the option slots of the control unit.

External control

When the supply unit is in external control, start/stop commands are given through the I/O terminals (digital and analog inputs), fieldbus interface (via an optional fieldbus adapter module), optional I/O extension modules or the drive-to-drive link.

Two external control locations, EXT1 and EXT2, are available. The user can select control signals (eg. start and stop) and control modes for both external control locations.

Depending on the user selection, either EXT1 or EXT2 is active at a time. Selection between EXT1/EXT2 is done via any binary source such as a digital input or fieldbus control word.

Local control

The start/stop commands are given from the control panel keypad or from a PC equipped with Drive composer when the supply unit is in local control.

Local control is mainly used during commissioning and maintenance. When switched to local control, the control panel Start and Stop keys override the external Start/Stop source defined for the control program. However, to control the supply unit on and off by the panel, you must still have the Run enable and Start enable commands on in the control program. See section [Run enable, Start/stop and Start enable control](#) on page 20. Changing the control location to local can be disabled by parameter [119.17 Local ctrl disable](#).

The user can select by a parameter ([149.05 Communication loss action](#)) how the supply unit reacts to a control panel or PC tool communication break.

Run enable, Start/stop and Start enable control

The user controls the operation of the diode supply unit with the Run enable command, Start/Stop command and Start enable command. When all commands are on in the control program, it controls the main contactor of the supply unit on with a relay output (relay output RO3 by default). The contactor connects the diode bridge to the power line and the diode supply unit starts rectifying. If the Start/stop command or the Run enable command is off, the control program de-energizes the relay output and the main contactor switches off.

There is a parameter in the control program for defining the value or source for each of the commands. By default, the parameters define the command values or sources as follows:

- Control program reads the Run enable command from digital input DI2.
- Control program reads the Start/Stop command from digital input DI2.
- Start enable is set on constantly.

Typically, DI2 is connected to the operating switch installed on the cabinet door. When the switch is on, the control program receives both the Run enable and Start/Stop commands via DI2. If the external charging feature is enabled in the control program, it will perform a separate charging sequence before closing the main contactor (see section [Charging of DxD supply unit](#) on page 35).

Note: When you switch the control panel to local control, the control program starts reading the Start/Stop from the panel (Start and Stop keys). The parameter-defined Start/Stop source is not valid until you switch the panel back to remote control. The Loc/Rem key of the panel selects between local and remote control.



WARNING! Do not change the parameter settings related to Run enable, Start/Stop or Start enable unless you are absolutely sure what you are doing. The parameter settings and I/O wirings of the cabinet-installed multidrive, ACS880-307 or ACS880-307LC, are done at the factory according to the application requirements.

■ Settings and diagnostics

Control panel key: Loc/Rem

Parameters: parameter group [119 Operation mode](#), [120.01 Ext1 commands...](#) [120.09 Ext2 in2](#), [120.12 Run enable 1](#), [120.19 Enable start signal](#)

Faults: [5E06 Main contactor fault](#)

■ Additional settings and diagnostics for DxT modules

Parameters: [195.01 Supply voltage](#)

Warnings: [AE61 Overvoltage](#), [AE62 Undervoltage](#), [AE69 Synchronization](#), [AE6B Input phase lost](#),

Faults: [2E00 Overcurrent](#), [2E09 DC short circuit](#), [3E05 DC link undervoltage](#), [3E06 BU DC link difference](#), [3E07 BU voltage difference](#), [3E0F Synchronization](#), [5E17 Running fault of 12 pulse](#), [8E00 Overvoltage](#)

Application programming

Note: This feature is not supported by the current firmware version.

The functions of the firmware program can be extended with application programming. (A standard drive delivery does not include an application program.) Application programs can be built out of function blocks based on the IEC-61131 standard. Some parameters are used as firmware function block inputs and can therefore be modified also via the application program.

Control interfaces

■ Programmable analog inputs

The control unit has two programmable analog inputs. Each of the inputs can be independently set as a voltage (0/2 ... 10 V or -10 ... 10 V) or current (0/4 ... 20 mA) input by a jumper or a switch on the control unit. Each input can be filtered, inverted and scaled. The number of analog inputs can be increased by using FIO-11 or FAIO-01 I/O extensions.

Analog input signal(s) can be in use in following cases of the DxD bridge:

1. If the DxD bridge DC link voltage monitoring function is activated in the control program, by default the program reads the measured voltage through analog input AI2 as current signal (optional). See parameter [195.40 DC voltage source](#). Parameter [195.01 Supply voltage](#) activates the function in case of diode-diode bridge.
2. If the DxD supply unit is equipped with a charging circuit, the DC link voltage measurement is connected to AI2 by default. See parameter [195.40 DC voltage source](#). For details, see the delivery-specific circuit diagrams and section [Charging of DxD supply unit](#) on page 35.
3. A special application program can use the analog inputs. There is no application program as standard but the customer can build one himself/herself. See section [Application programming](#) on page 21 for more information.

Settings

Parameter group [112 Standard AI](#) (page 60).

■ Programmable analog outputs

The control unit has two current (0 ... 20 mA) analog outputs. Each output can be filtered, inverted and scaled. The number of analog outputs can be increased by using FIO-11 or FAIO-01 I/O extensions.

Settings

Parameter group [113 Standard AO](#) (page 63).

■ Programmable digital inputs and outputs

The control unit has six digital inputs, a digital start interlock input, and two digital input/outputs.

Digital input/output DIO1 can be used as a digital input, digital output or frequency input, DIO2 as a digital input or digital output.

The number of digital inputs/outputs can be increased by installing FIO-01, FIO-11 or FDIO-01 I/O extensions (see [Programmable I/O extensions](#) below).

Note: Do not change the settings of the reserved digital inputs (or outputs, if any). See subsection [Reserved digital inputs and relay outputs](#) on page 42.

Settings

Parameter groups [110 Standard DI, RO](#) (page 53) and [111 Standard DIO, FI, FO](#) (page 58).

■ Programmable relay outputs

The control unit has three relay outputs. Relay outputs can be added by installing FIO-01 or FDIO-01 I/O extensions.

Note: Do not change the settings of the reserved relay outputs. See subsection [Reserved digital inputs and relay outputs](#) on page 42.

Settings

Parameter group [110 Standard DI, RO](#) (page 53).

■ Programmable I/O extensions

The number of inputs and outputs can be increased by using I/O extension modules. The I/O configuration parameters include the maximum number of DI, DIO, AI, AO and RO that can be in use with different I/O extension module combinations. Slots can be added by connecting an FEA-0x I/O extension adapter.

The table below shows the possible I/O combinations.

Location	Digital inputs (DI)	Digital I/Os (DIO)	Analog inputs (AI)	Analog outputs (AO)	Relay outputs (RO)
Control unit	7	2	2	2	3
FIO-01	-	4	-	-	2
FIO-11	-	2	3	1	-
FAIO-01	-	-	2	2	-
FDIO-01	3	-	-	-	2

Three I/O extension modules can be activated and configured using parameter groups [114 Extension I/O module 1...116 Extension I/O module 3](#).

Note: Each configuration parameter group contains parameters that display the values of the inputs on that particular extension module. These parameters are the only way of utilizing the inputs on I/O extension modules as signal sources. To connect to an input, choose the setting *Other* in the source selector parameter, then specify the appropriate value parameter (and bit, for digital signals) in group 114, 115 or 116.

Settings

Parameter groups [114 Extension I/O module 1](#) (page 66), [115 Extension I/O module 2](#) (page 81), [116 Extension I/O module 3](#) (page 85) and [112 Standard AI](#) (page 60).

■ **Fieldbus control**

The diode supply unit can be connected to an overriding control system via an optional fieldbus adapter. See chapter [Fieldbus control through a fieldbus adapter](#) (page 181).

Settings

Parameter groups [150 FBA](#) (page 111), [151 FBA A settings](#) (page 114), [152 FBA A data in](#) (page 116), [153 FBA A data out](#) (page 116), [154 FBA B settings](#) (page 116), [155 FBA B data in](#) (page 117), and [156 FBA B data out](#) (page 118).

External controller interface

General

The diode supply unit can be connected to an external controller (such as the ABB AC 800M) using either fiber optic or twisted-pair cable. The ACS880 is compatible with both the ModuleBus and DriveBus connections. Note that some features of DriveBus (such as BusManager) are not supported.

Topology

An example connection with either a ZCU-based or BCU-based diode supply unit using fiber optic cables is shown below.

Diode supply units with a **ZCU** control unit require an additional FDCO DDCS communication module; diode supply units with a **BCU** control unit require an RDCO or FDCO module. The BCU has a dedicated slot for the RDCO – an FDCO module can also be used with a BCU control unit but it will reserve one of the three universal option module slots. Ring and star configurations are also possible much in the same way as with the master/follower link; the notable difference is that the external controller connects to channel CH0 on the RDCO module instead of CH2. The channel on the FDCO communication module can be freely selected.

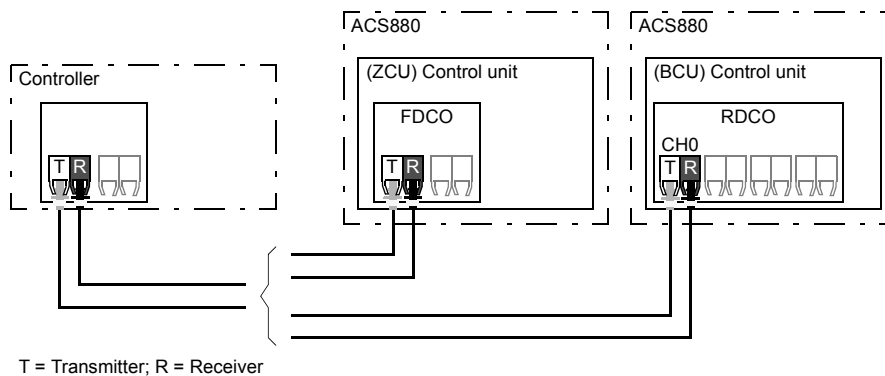

The external controller can also be wired to the D2D (RS-485) connector using shielded, twisted-pair cable. The selection of the connection is made by parameter [160.51 DDCS controller comm port](#).

Communication

The communication between the controller and the diode supply unit consists of data sets of three 16-bit words each. The controller sends a data set to the diode supply unit, which returns the next data set to the controller.

The communication uses data sets 10...33. The contents of the data sets are freely configurable, but data set 10 typically contains the control word, while data set 11 returns the status word and selected actual values.

The word that is defined as the control word is internally connected to the logic; the coding of the bits is as presented in section [Contents of the fieldbus Control word](#) (page 184). Likewise, the coding of the status word is as shown in section [Contents of the fieldbus Status word](#) (page 186).

By default, data sets 32 and 33 are dedicated for the mailbox service, which enables the setting or inquiry of parameter values as follows:

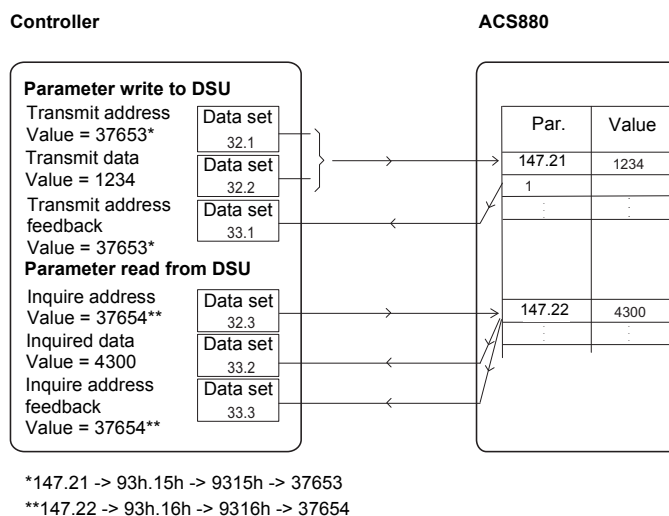

By parameter [160.64 Mailbox dataset selection](#), data sets 24 and 25 can be selected instead of data sets 32 and 33.

The update intervals of the data sets are as follows:

- Data sets 10...11: 2 ms
- Data sets 12...13: 4 ms
- Data sets 14...17: 10 ms
- Data sets 18...25, 32, 33: 100 ms.

Settings

Parameter groups [160 DDCS communication](#) (page 118), [161 DDCS transmit](#) (page 119) and [162 DDCS receive](#) (page 123).

DDCS communication with inverter unit

DDCS communication is used for transferring data between supply unit and inverter unit. The inverter unit can give charging and start commands for the supply unit via DDCS communication links. If the supply unit receives a start or charging command, it closes the main contactor of the supply unit and starts rectifying.

The DSU control program supports the DDCS communication protocol. The DDCS communication can be used in data transfer between the supply and inverter units. With the DDCS communication, it is possible to control and monitor the inverter and the diode supply unit through one fieldbus adapter (in the inverter unit).

For the supply modules, the system integrator can acquire the necessary cables and adapters for the physical link of the DDCS communication from ABB and install and set up the link on his/her own. Consult ABB for more information.

The supply unit control program have parameters for setting up the DDCS communication. The commission engineer can define the data that the supply unit sends to inverter units and reads from them, etc. For information on the DDCS communication, see section [Setting up the communication between DSU and inverter unit](#) on page 189.

■ Settings and diagnostics

Parameters: parameter groups [160 DDCS communication](#), [161 DDCS transmit](#), [162 DDCS receive](#)

Warnings: [AE6D DDCS controller comm loss](#)

Faults: [7E11 DDCS controller comm loss](#)

Data storage parameters

Twenty-four (sixteen 32-bit, eight 16-bit) parameters are reserved for data storage. These parameters are unconnected and can be used for linking, testing and commissioning purposes. They can be written to and read from using other parameters' source or target selections.

Settings

Parameter group [147 Data storage](#) (page 109).

Programmable protection functions

■ External events (parameters [131.01...131.10](#))

An external event signal can be connected to a selectable input. When the signal is lost, an external event (fault, warning, or a mere log entry) is generated.

■ Local control loss detection (parameter [149.05](#))

The parameter selects how the diode supply unit reacts to a control panel or PC tool communication break.

■ Earth leakage fault source selection (parameter [131.28](#))

The parameter selects in which digital input or digital input/output earth leakage fault is connected.

■ External earth leakage action selection (parameter [131.29](#))

The parameter selects how the diode supply unit reacts when an external earth leakage is detected.

■ Fuse trip fault source (parameter [131.38](#))

The parameter selects in which digital input or digital input/output fuse trip fault is connected.

■ Brake chopper fault source (parameter [131.39](#))

The parameter selects in which digital input or digital input/output brake chopper fault is connected.

■ Counting the number of charging attempts (DxD modules only)

The control program monitors charging attempts to prevent charging circuit overheating.

Settings and diagnostics

Parameters: [120.50 Charging overload event sel](#)

Warnings: [AE85 Charging count](#)

Faults: [3E09 Charging count](#)

■ Automatic fault resets

The diode supply unit can automatically reset itself after overvoltage, undervoltage and external faults. The user can also specify a fault that is automatically reset.

By default, automatic resets are off and must be specifically activated by the user.

Settings

Parameters [131.12...131.16](#) (page [97](#)).

Optional overvoltage and undervoltage protections of DxD module

The control program activates the DC voltage monitoring function automatically when it detects that the user-defined supply voltage value (parameter [195.01 Supply voltage](#)) is set. When the function is activated, it monitors the actual DC voltage value through analog input AI2 by default (see parameter [195.40 DC voltage source](#)). The DC link charging logic uses the measured voltage value in the on/off control of the additional charging circuit during the power up. The monitoring function also detects possible overvoltage and undervoltage situations: if the measured voltage exceeds the overvoltage limit or goes below the undervoltage limit, the control program trips to a fault and opens the main contactor/breaker.

Note: The DC voltage monitoring (or the related measurement circuit) is not in use in the cabinet-installed, air-cooled supply units of type ACS880-307 (+A003). These units are only sold with ABB inverters that already have their own DC link charging circuits. Therefore no common charging circuit in the supply unit is needed, and no voltage monitoring is needed either. For the same reason, no voltage monitoring is needed in a typical supply module installation either. See also section [Charging of DxD supply unit](#) on page [35](#).

Note: By default, analog input AI2 is reserved for the voltage measurement when the monitoring function is active. The parameters that define the processing of the AI2 signal have ready-set default values for the monitoring function as follows:

0 ... 20 mA signal range connected to AI2 corresponds to the actual DC voltage range of 0 ... 1920 V DC in the control program.

■ Settings and diagnostics

Parameters: [195.01 Supply voltage](#), [195.40 DC voltage source](#)

Faults: [3E04 DC link overvoltage](#), [3E05 DC link undervoltage](#)

Temperature supervision

Thermal switches supervise the temperature inside the diode supply module. The switches are connected in series and wired to a digital input (DI) of the control unit (1 = OK, 0 = overtemperature). In case of an overtemperature, a switch opens and the control program generates first a warning, and then, if the overtemperature indication remains over a pre-defined delay, trips the supply unit to a fault. The user can adjust the delay time with a parameter [110.06 DI1 OFF delay](#).

A temperature sensor integrated into the ZCU and BCU control unit supervises the ambient temperature of the control board. BCU control unit also supervises several other temperature sensors inside the DxT module.

■ Settings and diagnostics

Parameters: [110.06 DI1 OFF delay](#)

Warnings: [AE60 Control board temperature](#)

Fault: [4E06 Cabinet temperature fault](#), [4E07 Control board temperature](#)

■ Additional settings and diagnostics for DxT modules

Parameters: *101.31 Ambient temperature*, *105.11 Converter temperature %*

Warnings: *AE14 Excess temperature*, *AE15 Excess temperature difference*, *AE60 Control board temperature*, *AE6C Semiconductor temperature*

Faults: *4E03 Excess temperature*, *4E04 Excess temperature difference*, *4E07 Control board temperature*, *4E08 Semiconductor temperature*

Maintenance timers and counters

The program has six different maintenance timers or counters that can be configured to generate a warning when a pre-defined limit is reached. The contents of the message can be edited on the control panel by selecting **Settings – Edit texts**.

The timer/counter can be set to monitor any parameter. This feature is especially useful as a service reminder.

There are three types of counters:

- On-time timers. Measures the time a binary source (for example, a bit in a status word) is on.
- Signal edge counters. The counter is incremented whenever the monitored binary source changes state.
- Value counters. The counter calculates its actual value by integrating the monitored value with respect to time. For example, if you monitor the actual power with a value counter, the value counter calculates and displays the cumulative energy. You can also define limits and select indication messages for the counter.

■ Settings

Parameter group *133 Generic timer & counter* (page *101*).

Load analyzer

■ Peak value logger

The user can select a signal to be monitored by a peak value logger. The logger records the peak value of the signal along with the time the peak occurred, as well as line current, DC voltage and power at the time of the peak. The peak value is sampled at 2 ms intervals.

■ Amplitude loggers

The control program has two amplitude loggers.

For amplitude logger 2, the user can select a signal to be sampled at 200 ms intervals, and specify a value that corresponds to 100%. The collected samples are sorted into 10 read-only parameters according to their amplitude. Each parameter represents an amplitude range 10 percentage points wide, and displays the percentage of the collected samples that have fallen within that range.

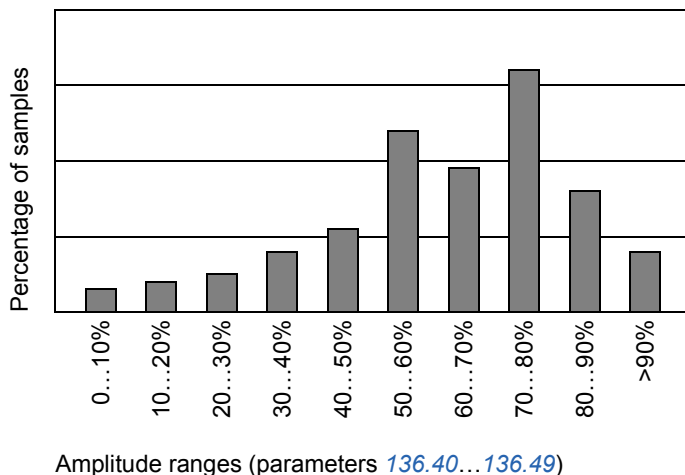











Amplitude logger 1 is fixed to AC current ([101.02 Line current](#)), and cannot be reset. With amplitude logger 1, 100% corresponds to the maximum current of the drive. The measured current is logged continuously. The distribution of samples is shown by parameters [136.20](#)...[136.29](#).

■ Settings

Parameter group [136 Load analyzer](#) (page [106](#)).

Default I/O connection diagram for DxD modules (ZCU)

Relay outputs		XRO1...XRO3	
XRO1: Running ¹⁾ (energized = running) 250 V AC / 30 V DC 2 A		NO	3
		COM	2
		NC	1
XRO2: Fault (-1) ²⁾ (energized = indicates no fault) 250 V AC / 30 V DC 2 A		NO	3
		COM	2
		NC	1
XRO3: MCB ctrl ²⁾ (energized = main contactor closed) 250 V AC / 30 V DC 2 A		NO	3
		COM	2
		NC	1
Power supply		XPOW	
24 V DC, 2 A		GND	2
		+24VI	1
Reference voltage and analog inputs		J1, J2, XAI	
AI1/AI2 current/voltage selection		AI1: U	AI2: U
		AI1: I	AI2: I
Not in use by default 0(4) ... 20 mA, $R_{in} = 100 \text{ ohm}^3)$		AI2-	7
		AI2+	6
Not in use by default 0(2) ... 10 V, $R_{in} > 200 \text{ kohm}^4)$		AI1-	5
		AI1+	4
Ground		AGND	3
-10 V DC, $R_L 1 \dots 10 \text{ kohm}$		-VREF	2
10 V DC, $R_L 1 \dots 10 \text{ kohm}$		+VREF	1
Analog outputs		XAO	
Zero ²⁾ 0 ... 20 mA, $R_L < 500 \text{ ohm}$		AGND	4
		AO2	3
Zero ²⁾ 0 ... 20 mA, $R_L < 500 \text{ ohm}$		AGND	2
		AO1	1
Drive-to-drive link (not connected by default)		J3, XD2D	
Drive-to-drive link termination ⁵⁾		ON 	OFF
Drive-to-drive link		Shield	4
		BGND	3
		A	2
		B	1
XSTO connector		XSTO	
XSTO connector. Both circuits (power module, control unit) must be closed to enable running or start of the supply unit. (IN1 and IN2 must be connected to OUT.) ⁹⁾		IN2	4
		IN1	3
		SGND	2
		OUT	1
Digital inputs		XDI	
Reset ²⁾ (0 -> 1 = fault reset)		DI6	6
Not in use by default. The earth fault monitoring option uses DI5.		DI5	5
Auxiliary circuit breaker fault ²⁾		DI4	4
MCB fb ⁶⁾ (1 = main breaker/contactor closed)		DI3	3
Run / enable ²⁾ (1 = run / enable)		DI2	2
Temp fault ²⁾ (0 = overtemperature)		DI1	1
Digital input/outputs		XDIO	
Not in use by default		DIO2	2
Not in use by default		DIO1	1
Ground selection ⁷⁾			
Auxiliary voltage output, digital input interlock		XD24	
Digital input/output ground		DI0GND	5
+24 V DC 200 mA ⁸⁾		+24VD	4
Digital input ground (common)		DICOM	3
+24 V DC 200 mA ⁸⁾		+24VD	2
Not in use by default		DIIL	1
Safety functions module connection (not in use in supply units)		X12	
Control panel connection		X13	
Memory unit connection		X205	

Notes:





Wire sizes and tightening torques: 0.5 ... 2.5 mm² (24 ... 12 AWG) and 0.5 N·m (5 lbf·in) for both stranded and solid wiring.

As the very same control program is in use with different diode supply types, the default connections are not applicable with them all. For example, some units have the DC link charging, some do not have it. The default parameter settings and I/O connection are valid for the version without the charging circuit.

By activating bit 15 of parameter [195.20 HW options word 1](#) the I/O defaults can be changed to an optimized setting for liquid-cooled ACS880 single drive. I/O connections for this setting are shown in the example circuit diagrams.

- 1) Use of the signal in the control program. When parameter [120.30 External charge enable](#) has value *Yes*, the control program reserves this I/O terminal for external charging circuit control and monitoring, and parameters [110.24 RO1 source](#) and [110.30 RO3 source](#) are write-protected. If the value is *No*, you can use the I/O terminal for other purposes.
 - 2) Default use of the signal in the control program. The use can be changed by a parameter. For the delivery-specific use, see the delivery-specific circuit diagrams.
 - 3) Current [0(4) ... 20 mA, $R_{in} = 100 \text{ ohm}$] or voltage [0(2) ... 10 V, $R_{in} > 200 \text{ kohm}$] input selected by jumper J1. Change of setting requires reboot of control unit. **Note:** When parameter [195.01 Supply voltage](#) has the default value (*Not given*), analog input AI2 is not in use. With other values of the parameter, the control program reads the measured DC voltage through AI1 or AI2. See the delivery-specific circuit diagrams or consult ABB for the wirings and components of the measurement circuit.
 - 4) Current [0(4) ... 20 mA, $R_{in} = 100 \text{ ohm}$] or voltage [0(2) ... 10 V, $R_{in} > 200 \text{ kohm}$] input selected by jumper J2. Change of setting requires reboot of control unit.
 - 5) Must be set to ON when the drive is the first or last unit on the drive-to-drive (D2D) link.
 - 6) Use of the signal in the control program. The use is fixed and it cannot be changed by a parameter.
 - 7) Determines whether DICOM is separated from DIOGND (ie. common reference for digital inputs floats).
 • DICOM connected to DIOGND. • DICOM and DIOGND separate.
 - 8) Total load capacity of these outputs is 4.8 W (200 mA / 24 V) minus the power taken by DIO1 and DIO2.
 - 9) This input is used in inverter units only, not in supply units. This input only acts as a true Safe torque off input in control units controlling an inverter unit. In other applications (such as a supply or brake unit), de-energizing the IN1 and/or IN2 terminal will stop the unit but not constitute a true safety function.
-

Default I/O connection diagram for DxT modules (BCU)

XD2D		Drive-to-drive link
1	B	Drive-to-drive link (not in use by default)
2	A	
3	BGND	
4	Shield	
X485		RS485 connection
5	B	Not in use (not in use by default)
6	A	
7	BGND	
8	Shield	
XRO1...XRO3		Relay outputs
11	NC	 XRO1: Running ²⁾ (energized = running) 250 V AC / 30 V DC / 2 A
12	COM	
13	NO	
21	NC	 XRO2: Fault(-1) ²⁾ (Energized = no fault) 250 V AC / 30 V DC / 2 A
22	COM	
23	NO	
31	NC	 XRO3: MCB ctrl ¹⁾ (Energized = closes main contactor/breaker) 250 V AC / 30 V DC / 2 A
32	COM	
33	NO	
XSTO		XSTO connector
1	OUT	 XSTO connector. Both circuits (power module, control unit) must be closed to enable running or start of the supply unit. (IN1 and IN2 must be connected to OUT.) ⁸⁾
2	SGND	
3	IN1	
4	IN2	
5	IN1	Not in use
6	SGND	
7	IN2	
8	SGND	
XDI		Digital inputs
1	DI1	Temp fault ²⁾ (0 = overtemperature)
2	DI2	Run / enable ²⁾ (1 = run / enable)
3	DI3	MCB fb ¹⁾ (0 = main contactor/breaker open)
4	DI4	Auxiliary circuit breaker fault ²⁾
5	DI5	Not in use by default. Can be used for eg. earth fault monitoring.
6	DI6	Reset ²⁾ (0 -> 1 = fault reset)
7	DIIL	Not in use by default. Can be used for eg. emergency stop.
XDIO		Digital input/outputs
1	DIO1	Not in use by default
2	DIO2	Not in use by default
3	DIOGND	Digital input/output ground
4	DIOGND	Digital input/output ground
XD24		Auxiliary voltage output
5	+24VD	+24 V DC 200 mA ⁶⁾
6	DICOM	Digital input ground
7	+24VD	+24 V DC 200 mA ⁶⁾
8	DIOGND	Digital input/output ground
DICOM=DIOGND		Ground selection switch ⁷⁾
XAI		Analog inputs, reference voltage output
1	+VREF	10 V DC, R_L 1...10 kohm
2	-VREF	-10 V DC, R_L 1...10 kohm
3	AGND	Ground
4	AI1+	Not in use by default.
5	AI1-	0(2)...10 V, $R_{in} > 200$ kohm ³⁾
6	AI2+	Not in use by default.
7	AI2-	0(4)...20 mA, $R_{in} = 100$ ohm ⁴⁾
XAO		Analog outputs
1	AO1	Zero ²⁾ 0...20 mA, $R_L < 500$ ohm
2	AGND	
3	AO2	Zero ²⁾ 0...20 mA, $R_L < 500$ ohm
4	AGND	
XPOW		External power input
1	+24VI	24 V DC, 2.05 A
2	GND	
3	+24VI	
4	GND	
X12		Safety functions module connection (not in use in supply units)
X13		Control panel connection
X205		Memory unit connection

The table above shows the control connections of the supply unit, and the default meaning or use of the signals in the supply unit control program.

There are additional fiber optics connections from the BCU control unit to DxT modules.

Notes:

Wire sizes and tightening torques: 0.5 ... 2.5 mm² (24...12 AWG) and 0.5 N·m (5 lbf·in) for both stranded and solid wiring.

As the very same control program is in use with different diode supply types, the default connections are not applicable with them all. For example, some units have the DC link charging, some do not have it. The default parameter settings and I/O connection are valid for the version without the charging circuit.

- 1) Use of the signal in the control program. The use is fixed and it cannot be changed by a parameter.
 - 2) Default use of the signal in the control program. The use can be changed by a parameter. For the delivery-specific use, see the delivery-specific circuit diagrams.
 - 3) Current [0(4)...20 mA, $R_{in} = 100 \text{ ohm}$] or voltage [0(2)...10 V, $R_{in} > 200 \text{ kohm}$] input selected by switch AI1. Change of setting requires reboot of control unit.
 - 4) Current [0(4)...20 mA, $R_{in} = 100 \text{ ohm}$] or voltage [0(2)...10 V, $R_{in} > 200 \text{ kohm}$] input selected by switch AI2. Change of setting requires reboot of control unit.
 - 5) Must be set to ON when the drive is the first or last unit on the drive-to-drive (D2D) link.
 - 6) Total load capacity of these outputs is 4.8 W (200 mA at 24 V) minus the power taken by DIO1 and DIO2.
 - 7) Determines whether DICOM is separated from DIOGND (ie. common reference for digital inputs floats).
DICOM = DIOGND ON: DICOM connected to DIOGND. OFF: DICOM and DIOGND separate.
 - 8) This input is used in inverter units only, not in supply units. This input only acts as a true Safe torque off input in control units controlling an inverter unit. In other applications (such as a supply or brake unit), de-energizing the IN1 and/or IN2 terminal will stop the unit but not constitute a true safety function.
-

Charging of DxD supply unit

The charging is always needed to power up the drive DC link capacitors smoothly. In other words: you may not connect the discharged capacitors to full supply voltage but you must increase the voltage gradually until the capacitors are charged and ready for normal use.

The control program has a function for controlling an additional charging circuit in the supply unit. The charging function is inactive as standard. Cabinet-installed, air-cooled supply unit of type ACS880-307 (+A003) does not have or need an additional charging circuit because it is only used with frame R1i to R7i inverter modules which charge their DC link capacitors by themselves.

The rectifier bridge in ACS880-304 +A003 and ACS880-304LC +A019 supply module is uncontrolled: it cannot control the DC link voltage and limit the charging current of the DC link capacitors at the power up. Therefore you can only use the bridge with inverters that have internal charging circuits, or you must equip the supply unit with a separate, external charging circuit. The control program allows the use of an external charging circuit.

In air-cooled diode supply units, DC voltage measurement signal must be connected to AI2. In liquid-cooled diode supply units, the inverter unit measures DC voltage of the drive DC link and sends the value to the diode supply unit either through its analog input AI2, or a fiber optic link. DC voltage source is selected with parameter [195.40 DC voltage source](#). Selection [AI2 scaled value](#) (default value) is typically used with air-cooled diode supply units, and selection [External measurement signal](#) with liquid-cooled diode supply units. If the diode supply unit recognizes overvoltage or undervoltage situations, it trips the main contactor/breaker.

Charging is ready when the DC voltage > [120.25 MCB closing level](#) and the DC voltage $dU/dt < 120.26$ [Maximum dU/dt](#). If charging takes more time than [120.23 Max DC charging time](#), the supply unit trips on fault [3E08 LSU charging](#).

The control program monitors charging attempts to prevent charging circuit overheating. If there are more than two attempts in five minutes to charge the DC link externally, start inhibit is set ([106.18 Start inhibit status word](#), bit 9). After five minutes from the first charging attempt the start inhibit is removed. The supply unit also generates an event selected with parameter [120.50 Charging overload event sel](#).

If the supply unit is used in a drive system where the charging must be done by the supply unit, you must install an additional charging circuit, and activate and tune the charging function in the supply control program. If you need more information on wiring the components and tuning the parameters, consult your local ABB representative.

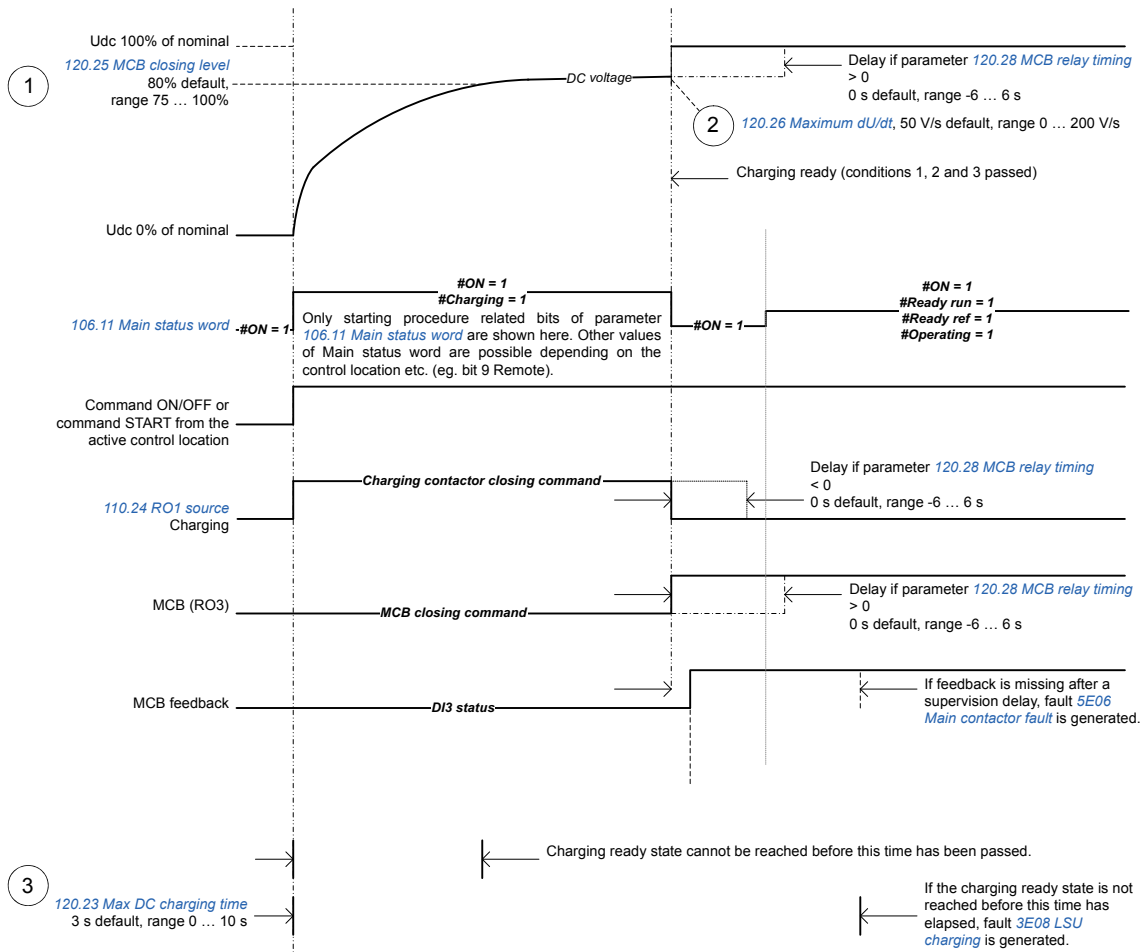

■ Settings and diagnostics

Parameters: *110.24 RO1 source*, *120.21 Delay for MCB DI3 supervision*, *120.23 Max DC charging time*, *120.25 MCB closing level*, *120.26 Maximum dU/dt*, *120.28 MCB relay timing*, *120.30 External charge enable*, *120.50 Charging overload event sel*, *120.60 DC voltage external unscaled*, *120.61 External DC voltage scale*, *195.01 Supply voltage*, *195.40 DC voltage source*

Faults: *3E08 LSU charging*

Charging of DxT supply unit

The main difference between the ordinary diode-diode bridge and the controlled diode-thyristor bridge is the controllability. You cannot control the operation of the diodes but you can control the thyristors: thyristor can be kept blocked or controlled conductive in forward direction. By controlling the thyristors, you can limit the AC current of the drive at the power up without additional charging circuit in the supply unit or in inverter units.

The control program charges the DC link by decreasing the firing angle after closing of main contactor/breaker. If the peak of the charging current is above 30% of the nominal current, the charging ramp is stopped. After ramping the supply changes from charging mode to diode mode with 120 degree firing pulses.

■ Settings and diagnostics

Note: Normally, there is no need to set any other parameters than *195.01 Supply voltage*.

Parameters: *120.21 Delay for MCB DI3 supervision*, *195.01 Supply voltage*

Warnings: *AE61 Overvoltage*, *AE62 Undervoltage*, *AE69 Synchronization*, *AE6B Input phase lost*

Faults: *2E00 Overcurrent*, *2E09 DC short circuit*, *3E05 DC link undervoltage*, *3E06 BU DC link difference*, *3E07 BU voltage difference*, *3E0F Synchronization*, *5E06 Main contactor fault*, *5E17 Running fault of 12 pulse*, *8E00 Overvoltage*

Reduced run function

Reduced run function is available for diode supply units consisting of parallel-connected diode supply modules. The function makes it possible to continue operation with limited current even if one (or more) module is out of service, for example, because of maintenance work. In principle, reduced run is possible with only one module, but in practice, the modules in service must be able to provide enough current for running the inverter modules.

The number of removed diode supply modules is restricted. The following tables list the allowed configurations.

Note: When diode supply modules are removed, the corresponding AC fuses need to be removed too.

■ 6-pulse diode supply unit

Original configuration	Allowed configurations when using reduced run function
2×DSU module	1×DSU module
3×DSU	2×DSU or 1×DSU
4×DSU	3×DSU or 2×DSU or 1×DSU
5×DSU	4×DSU or 3×DSU or 2×DSU or 1×DSU
6×DSU	5×DSU or 4×DSU or 3×DSU or 2×DSU or 1×DSU

■ 12-pulse diode supply unit

Note: Reduced run function is not supported at the time of publication in 12-pulse diode supply units.

With 12-pulse diode supply unit, both secondary windings of the 12-pulse transformer must have the same number of diode supply modules. When using reduced run function with 12-pulse diode supply unit, two diode supply modules are removed at a time.

Original configuration	Allowed configurations when using reduced run function
4×DSU	2×DSU
6×DSU	4×DSU or 2×DSU

■ Activation of the reduced run function

Note: For cabinet-built drives, the wiring accessories and the air baffle needed during the procedure are available from ABB, and are included in the delivery.



WARNING! Follow the safety instructions provided for the diode supply unit in question.

1. Disconnect the supply voltage and all other sources that can supply the DC bus (eg. DC/DC converter) from the diode supply unit.
2. If the control unit of the diode supply unit is powered from the faulty module, install an extension to the wiring and connect it to one of the remaining modules.
3. Remove the module to be serviced from its bay. See the appropriate hardware manual for instructions.
4. Install an air baffle to the top module guide to block the airflow through the empty module bay.
5. Switch on the power to the diode supply unit.
6. Enter the number of diode supply modules present into parameter *195.13 Reduced run mode*.
7. Reset all faults and start the diode supply unit. The maximum current is now automatically limited according to the new configuration. A mismatch between the number of detected modules and the value set in *195.13* will generate a fault (*5E0E Reduced run*).

After all modules have been reinstalled, parameter *195.13 Reduced run mode* must be reset to 0 to disable the reduced run function.

■ Settings and diagnostics

Parameters: *195.13 Reduced run mode*, *195.14 Connected modules*

Faults: *5E0E Reduced run*

User lock

For better cybersecurity, it is highly recommended that you set a master pass code to prevent eg. the changing of parameter values and/or the loading of firmware and other files.



WARNING! ABB will not be liable for damages or losses caused by the failure to activate the user lock using a new pass code. See [Cybersecurity disclaimer](#) (page 12).

To activate the user lock for the first time, enter the default pass code, 10000000, into [196.02 Pass code](#). This will make parameters [196.100...196.102](#) visible. Then enter a new pass code into [196.100 Change user pass code](#), and confirm the code in [196.101 Confirm user pass code](#). In [196.102 User lock functionality](#), define the actions that you want to prevent (we recommend you select all the actions unless otherwise required by the application).

To close the user lock, enter an invalid pass code into [196.02 Pass code](#), activate [196.08 Control board boot](#), or cycle the power. With the lock closed, parameters [196.100...196.102](#) are hidden.

To reopen the lock, enter your pass code into [196.02 Pass code](#). This will again make parameters [196.100...196.102](#) visible.

■ Settings

Parameters [196.02](#) (page 131) and [196.100...196.102](#) (page 134).

5

Parameters

What this chapter contains

The chapter describes the parameters, including actual signals, of the control program.

Terms and abbreviations

Term	Definition
Actual signal	Type of parameter that is the result of a measurement or calculation by the supply unit, or contains status information.
Def	(In the following table, shown on the same row as the parameter name.) Default value of a Parameter for the Factory macro.
FbEq16	(In the following table, shown on the same row as the parameter range, or for each selection.) 16-bit fieldbus equivalent. Scaling between the value shown on the panel and the integer used in fieldbus communication when a 16-bit value is selected for transmission to an external system. Dash (-) indicates that the parameter is not accessible in 16-bit format. Corresponding 32-bit scalings are listed in chapter Additional parameter data (page 137).
Other	The value is taken from another parameter. Choosing "Other" displays a parameter list in which the user can specify the source parameter. Note: The source parameter must be a 32-bit real (floating point) number. To use a 16-bit integer (for example, received from an external device in data sets) as the source, data storage parameters 147.01...147.08 (page 109) can be used.
Other [bit]	Value is taken from a specific bit in another parameter. Choosing "Other" displays a parameter list in which the user can specify the source parameter and bit.
Parameter	Either an user-adjustable operating instruction for the diode supply unit, or an actual signal.
p.u.	Per unit

Reserved digital inputs and relay outputs

Do not change the settings of the reserved digital inputs or relay outputs. For the cabinet-installed multidrive, ACS880-307 or ACS880-307LC, digital inputs and relay outputs are typically defined in use and connected to the appropriate control circuits already at the factory. See the delivery-specific circuit diagrams and subsections [Default I/O connection diagram for DxD modules \(ZCU\)](#) on page 31, and [Default I/O connection diagram for DxT modules \(BCU\)](#) on page 33.

Summary of parameter groups

Group	Contents	Page
101 Actual values	Basic signals for monitoring of the supply unit.	44
104 Warnings and faults	Information on warnings and faults that occurred last.	45
105 Diagnostics	Various run-time-type counters and measurements related to diode supply unit maintenance.	46
106 Control and status words	Control and status words.	47
107 System info	Hardware and firmware information.	53
110 Standard DI, RO	Configuration of digital inputs and relay outputs.	53
111 Standard DIO, FI, FO	Configuration of digital input/outputs and frequency inputs/outputs.	58
112 Standard AI	Configuration of analog inputs.	60
113 Standard AO	Configuration of analog outputs.	63
114 Extension I/O module 1	Configuration of I/O extension module 1.	66
115 Extension I/O module 2	Configuration of I/O extension module 2.	81
116 Extension I/O module 3	Configuration of I/O extension module 3.	85
119 Operation mode	Selection of external control location sources and operating modes.	88
120 Start/stop	Start/stop and run/start enable signal source selection; charging settings.	89
121 Start/stop mode	Start and stop modes; emergency stop mode and signal source selection.	94
131 Fault functions	Settings that define the behavior of the supply unit upon fault situations.	94
133 Generic timer & counter	Configuration of maintenance timers/counters.	101
136 Load analyzer	Peak value and amplitude logger settings.	106
147 Data storage	Parameters that can be written to and read from by using source and target settings of other parameters.	109
149 Panel port communication	Communication settings for the control panel port on the supply unit.	110
150 FBA	General settings for fieldbus communication configuration.	111
151 FBA A settings	Fieldbus adapter A configuration.	114
152 FBA A data in	Selection of data to be transferred from supply unit to fieldbus controller through fieldbus adapter A.	116
153 FBA A data out	Selection of data to be transferred from fieldbus controller to supply unit through fieldbus adapter A.	116
154 FBA B settings	Fieldbus adapter B configuration.	116
155 FBA B data in	Selection of data to be transferred from the diode supply unit to fieldbus controller through fieldbus adapter B.	117
156 FBA B data out	Selection of data to be transferred from fieldbus controller to supply unit through fieldbus adapter B.	118
160 DDCS communication	DDCS communication configuration.	118
161 DDCS transmit	Defines the data sent to the DDCS link.	119
162 DDCS receive	Mapping of data received through the DDCS link.	123

Group	Contents	Page
<i>190 Additional actual values</i>	Additional actual values of 6-pulse diode-thyristor bridge or modules connected to first winding of 12-pulse diode supply unit.	<i>126</i>
<i>192 Additional actual values 2</i>	Additional actual values of modules connected to second winding of 12-pulse diode supply unit.	<i>127</i>
<i>195 HW configuration</i>	Various hardware-related settings.	<i>128</i>
<i>196 System</i>	Language selection; pass code; parameter save and restore; control unit reboot; user lock.	<i>131</i>
<i>206 I/O bus configuration</i>	Basic configuration of the distributed I/O bus.	<i>135</i>
<i>207 I/O bus service</i>	Distributed I/O bus service.	<i>135</i>
<i>208 I/O bus diagnostics</i>	Diagnostic counters of the distributed I/O bus.	<i>135</i>
<i>209 I/O bus fan identification</i>	Fan identification run on the distributed I/O bus.	<i>135</i>

Parameter listing



WARNING! Do not change any parameter settings unless you are absolutely sure what you are doing. The parameter settings and I/O wirings of the cabinet-installed multidrive are done at the factory according to the application requirements.

No.	Name/Value	Description	Def/FbEq16
101 Actual values		Basic signals for monitoring of the supply unit.	
101.01	<i>DC voltage</i>	Measured intermediate circuit voltage [V]. <u>DxD modules only:</u> Note: This signal is activated when the optional DC voltage measurement is enabled.	-
	0.00...2000.00 V	Intermediate circuit voltage.	1 = 1 V
101.02	<i>Line current</i>	<u>DxT modules only:</u> Average rms value of phase currents [A].	-
	0.00...30000.00 A	Phase current.	1 = 1 A
101.03	<i>Line current %</i>	<u>DxT modules only:</u> Average rms value of phase currents [%].	-
	0.0...1000.0%	Phase current in percent of nominal current.	1 = 1%
101.08	<i>Frequency</i>	<u>DxT modules only:</u> Grid frequency [Hz].	-
	0.00...100.00 Hz	Grid frequency.	100 = 1 Hz
101.09	<i>Grid voltage</i>	<u>DxT modules only:</u> Average rms value of grid main voltages [V].	-
	0.00...2000.00 V	Grid main voltage.	1 = 1 V
101.12	<i>Power</i>	<u>DxT modules only:</u> Power [kW].	-
	-30000.00... 30000.00 kW	Power.	1 = 1 kW
101.13	<i>Power %</i>	<u>DxT modules only:</u> Power in percent of nominal [%].	-
	-1000.0...1000.0%	Power in percent of nominal.	1 = 1 %
101.22	<i>kWh supply</i>	<u>DxT modules only:</u> Counts the net kWh.	-
	-1000...1000 kWh	kWh value.	10 = 1 kWh
101.23	<i>MWh supply</i>	<u>DxT modules only:</u> Counts the net MWh.	-
	-1000...1000 MWh	MWh value.	1 = 1 MWh
101.24	<i>GWh supply</i>	<u>DxT modules only:</u> Counts the net GWh.	-
	-32768... 32767 GWh	GWh value.	1 = 1 GWh
101.31	<i>Ambient temperature</i>	<u>DxT modules only:</u> Temperature of module incoming air [°C].	-
	-30000.0... 30000.0 °C	Ambient temperature.	1 = 1 °C
101.61	<i>Nominal supply voltage</i>	<u>DxT modules only:</u> Nominal supply voltage of the converter [V].	-
	0...2000 V	Nominal supply voltage.	1 = 1 V
101.62	<i>Nominal DC voltage</i>	<u>DxT modules only:</u> Nominal DC voltage of the converter [V].	-
	0...2000 V	Nominal DC voltage.	1 = 1 V
101.63	<i>Nominal current</i>	<u>DxT modules only:</u> Nominal current of the converter [A].	-
	0...30000 A	Nominal current.	1 = 1 A
101.64	<i>Nominal power</i>	<u>DxT modules only:</u> Nominal power of the converter [kW].	-
	0...30000 kW	Nominal power.	1 = 1 kW

No.	Name/Value	Description	Def/FbEq16
101.70	<i>Ambient temperature percent</i>	<u>DxT modules only</u> : Ambient temperature of supply unit in percent. 0...100% corresponds to 0...60 °C or 32...140 °F. See also 101.31 Ambient temperature .	-
	-200.00...200.00%	Ambient temperature in percent.	1 = 1%
104 Warnings and faults		Information on warnings and faults that occurred last. For explanations of individual warning and fault codes, see chapter Fault tracing . All parameters in this group are read-only unless otherwise noted.	
104.01	<i>Tripping fault</i>	Code of the 1 st active fault (the fault that caused the current trip).	-
	0000h...FFFFh	1 st active fault.	1 = 1
104.02	<i>Active fault 2</i>	Code of the 2 nd active fault.	-
	0000h...FFFFh	2 nd active fault.	1 = 1
104.03	<i>Active fault 3</i>	Code of the 3 rd active fault.	-
	0000h...FFFFh	3 rd active fault.	1 = 1
104.04	<i>Active fault 4</i>	Code of the 4 th active fault.	-
	0000h...FFFFh	4 th active fault.	1 = 1
104.05	<i>Active fault 5</i>	Code of the 5 th active fault.	-
	0000h...FFFFh	5 th active fault.	1 = 1
104.06	<i>Active warning 1</i>	Code of the 1 st active warning.	-
	0000h...FFFFh	1 st active warning.	1 = 1
104.07	<i>Active warning 2</i>	Code of the 2 nd active warning.	-
	0000h...FFFFh	2 nd active warning.	1 = 1
104.08	<i>Active warning 3</i>	Code of the 3 rd active warning.	-
	0000h...FFFFh	3 rd active warning.	1 = 1
104.09	<i>Active warning 4</i>	Code of the 4 th active warning.	-
	0000h...FFFFh	4 th active warning.	1 = 1
104.10	<i>Active warning 5</i>	Code of the 5 th active warning.	-
	0000h...FFFFh	5 th active warning.	1 = 1
104.11	<i>Latest fault</i>	Code of the 1 st stored fault.	-
	0000h...FFFFh	1 st stored fault.	1 = 1
104.12	<i>2nd latest fault</i>	Code of the 2 nd stored fault.	-
	0000h...FFFFh	2 nd stored fault.	1 = 1
104.13	<i>3rd latest fault</i>	Code of the 3 rd stored fault.	-
	0000h...FFFFh	3 rd stored fault.	1 = 1
104.14	<i>4th latest fault</i>	Code of the 4 th stored fault.	-
	0000h...FFFFh	4 th stored fault.	1 = 1
104.15	<i>5th latest fault</i>	Code of the 5 th stored fault.	-
	0000h...FFFFh	5 th stored fault.	1 = 1
104.16	<i>Latest warning</i>	Code of the 1 st stored warning.	-
	0000h...FFFFh	1 st stored warning.	1 = 1

46 Parameters

No.	Name/Value	Description	Def/FbEq16
104.17	<i>2nd latest warning</i>	Code of the 2 nd stored warning.	-
	0000h...FFFFh	2 nd stored warning.	1 = 1
104.18	<i>3rd latest warning</i>	Code of the 3 rd stored warning.	-
	0000h...FFFFh	3 rd stored warning.	1 = 1
104.19	<i>4th latest warning</i>	Code of the 4 th stored warning.	-
	0000h...FFFFh	4 th stored warning.	1 = 1
104.20	<i>5th latest warning</i>	Code of the 5 th stored warning.	-
	0000h...FFFFh	5 th stored warning.	1 = 1
<i>105 Diagnostics</i>		Various run-time-type counters and measurements related to diode supply unit maintenance. All parameters in this group are read-only unless otherwise noted.	
105.01	<i>On-time counter</i>	On-time counter. The counter runs when the supply unit is powered.	-
	0...65535 d	On-time counter.	1 = 1 d
105.02	<i>Run-time counter</i>	DSU run-time counter. The counter runs when the diode supply unit is running and has closed the main circuit breaker.	-
	0...65535 d	DSU run-time counter.	1 = 1 d
105.04	<i>Fan on-time counter</i>	<u>DxT modules only</u> : Running time of the cooling fan. Can be reset on the control panel by keeping Reset depressed for over 3 seconds.	-
	0...65535 d	Cooling fan run-time counter.	1 = 1 d
105.11	<i>Converter temperature %</i>	<u>DxT modules only</u> : Converter semiconductor temperature in percent of the fault limit.	-
	-40.0...160.0%	Converter temperature in percent.	1 = 1%
105.21	<i>MCB closing time counter</i>	<u>DxD modules only</u> : Counts the closures of the main circuit breaker (MCB). This parameter can be used for maintenance purposes. Depending on application, the maintenance interval of the main circuit breaker may vary. See the maintenance instructions of the main circuit breaker.	-
	0...4294967295	Count of closures of main circuit breaker.	1 = 1

No.	Name/Value	Description	Def/FbEq16																																		
<i>106 Control and status words</i>		Control and status words.																																			
<i>106.01</i>	<i>Main control word</i>	<p>The main control word of the diode supply unit. This parameter shows the control signals as received from the selected sources (such as digital inputs, the fieldbus interfaces, etc.).</p> <p>This parameter is read-only.</p> <p>The bit assignments are shown in the table below. For detailed bit descriptions, see page 184.</p> <table border="1" data-bbox="678 609 1015 1162"> <thead> <tr> <th>Bit</th> <th>Name</th> </tr> </thead> <tbody> <tr><td>0</td><td>ON/OFF</td></tr> <tr><td>1</td><td>Off2 control</td></tr> <tr><td>2</td><td>Off3 control</td></tr> <tr><td>3</td><td>Start</td></tr> <tr><td>4</td><td>-</td></tr> <tr><td>5</td><td>-</td></tr> <tr><td>6</td><td>-</td></tr> <tr><td>7</td><td>Reset</td></tr> <tr><td>8</td><td>-</td></tr> <tr><td>9</td><td>-</td></tr> <tr><td>10</td><td>Remote cmd</td></tr> <tr><td>11</td><td>Ext ctrl loc</td></tr> <tr><td>12</td><td>User bit 0</td></tr> <tr><td>13</td><td>User bit 1</td></tr> <tr><td>14</td><td>User bit 2</td></tr> <tr><td>15</td><td>User bit 3</td></tr> </tbody> </table>	Bit	Name	0	ON/OFF	1	Off2 control	2	Off3 control	3	Start	4	-	5	-	6	-	7	Reset	8	-	9	-	10	Remote cmd	11	Ext ctrl loc	12	User bit 0	13	User bit 1	14	User bit 2	15	User bit 3	-
Bit	Name																																				
0	ON/OFF																																				
1	Off2 control																																				
2	Off3 control																																				
3	Start																																				
4	-																																				
5	-																																				
6	-																																				
7	Reset																																				
8	-																																				
9	-																																				
10	Remote cmd																																				
11	Ext ctrl loc																																				
12	User bit 0																																				
13	User bit 1																																				
14	User bit 2																																				
15	User bit 3																																				
	0000h...FFFFh	Main control word.	1 = 1																																		
<i>106.03</i>	<i>FBA A transparent control word</i>	<p>The unaltered control word received from the PLC through fieldbus adapter A.</p> <p>This parameter is read-only.</p>	-																																		
	00000000h ... FFFFFFFFh	Control word received through fieldbus adapter A.	-																																		
<i>106.04</i>	<i>FBA B transparent control word</i>	<p>The unaltered control word received from the PLC through fieldbus adapter B.</p> <p>This parameter is read-only.</p>	-																																		
	00000000h ... FFFFFFFFh	Control word received through fieldbus adapter B.	-																																		

48 Parameters

No.	Name/Value	Description	Def/FbEq16																																																
106.11	Main status word	<p>Main status word of the diode supply unit.</p> <p>Reflects the status of the supply unit irrespective of control source, eg. a fieldbus system, control panel (keypad), PC tool, standard I/O, application program or sequence programming, and irrespective of actual control profile which is used to control the supply unit.</p> <p>This parameter is read-only.</p> <p>The bit assignments are shown in the table below. For detailed bit descriptions, see page 186.</p> <table border="1"> <thead> <tr> <th>Bit</th> <th>Name</th> </tr> </thead> <tbody> <tr><td>0</td><td>Ready to switch ON</td></tr> <tr><td>1</td><td>Ready run</td></tr> <tr><td>2</td><td>Ready ref</td></tr> <tr><td>3</td><td>Tripped</td></tr> <tr><td>4</td><td>-</td></tr> <tr><td>5</td><td>-</td></tr> <tr><td>6</td><td>-</td></tr> <tr><td>7</td><td>Warning</td></tr> <tr><td>8</td><td>Operating</td></tr> <tr><td>9</td><td>Remote</td></tr> <tr><td>10</td><td>Ready for load</td></tr> <tr><td>11</td><td>User bit 0</td></tr> <tr><td>12</td><td>User bit 1</td></tr> <tr><td>13</td><td>User bit 2</td></tr> <tr><td>14</td><td>Charging</td></tr> <tr><td>15</td><td>User bit 3</td></tr> </tbody> </table>	Bit	Name	0	Ready to switch ON	1	Ready run	2	Ready ref	3	Tripped	4	-	5	-	6	-	7	Warning	8	Operating	9	Remote	10	Ready for load	11	User bit 0	12	User bit 1	13	User bit 2	14	Charging	15	User bit 3	-														
Bit	Name																																																		
0	Ready to switch ON																																																		
1	Ready run																																																		
2	Ready ref																																																		
3	Tripped																																																		
4	-																																																		
5	-																																																		
6	-																																																		
7	Warning																																																		
8	Operating																																																		
9	Remote																																																		
10	Ready for load																																																		
11	User bit 0																																																		
12	User bit 1																																																		
13	User bit 2																																																		
14	Charging																																																		
15	User bit 3																																																		
	0000h...FFFFh	Main status word.	1 = 1																																																
106.16	Drive status word 1	<p>Status word 1 of the supply unit.</p> <p>This parameter is read-only.</p> <table border="1"> <thead> <tr> <th>Bit</th> <th>Name</th> <th>Description</th> </tr> </thead> <tbody> <tr><td>0</td><td>Enabled</td><td>1 = Run enable and start enable signals are present</td></tr> <tr><td>1</td><td>Inhibited</td><td>1 = Start inhibited</td></tr> <tr><td>2</td><td>Reserved</td><td></td></tr> <tr><td>3</td><td>Reserved</td><td></td></tr> <tr><td>4</td><td>Reserved</td><td></td></tr> <tr><td>5</td><td>Started</td><td>1 = DSU has been started</td></tr> <tr><td>6</td><td>Reserved</td><td></td></tr> <tr><td>7</td><td>Reserved</td><td></td></tr> <tr><td>8</td><td>Local control</td><td>1 = DSU is in local control</td></tr> <tr><td>9</td><td>Network control</td><td>1 = DSU is in network control</td></tr> <tr><td>10</td><td>Ext1 active</td><td>1 = Control location Ext1 active</td></tr> <tr><td>11</td><td>Ext2 active</td><td>1 = Control location Ext2 active</td></tr> <tr><td>12</td><td>Charging</td><td>1 = Charging relay is closed</td></tr> <tr><td>13</td><td>MCB</td><td>1 = MCB relay is closed</td></tr> <tr><td>14...15</td><td>Reserved</td><td></td></tr> </tbody> </table>	Bit	Name	Description	0	Enabled	1 = Run enable and start enable signals are present	1	Inhibited	1 = Start inhibited	2	Reserved		3	Reserved		4	Reserved		5	Started	1 = DSU has been started	6	Reserved		7	Reserved		8	Local control	1 = DSU is in local control	9	Network control	1 = DSU is in network control	10	Ext1 active	1 = Control location Ext1 active	11	Ext2 active	1 = Control location Ext2 active	12	Charging	1 = Charging relay is closed	13	MCB	1 = MCB relay is closed	14...15	Reserved		-
Bit	Name	Description																																																	
0	Enabled	1 = Run enable and start enable signals are present																																																	
1	Inhibited	1 = Start inhibited																																																	
2	Reserved																																																		
3	Reserved																																																		
4	Reserved																																																		
5	Started	1 = DSU has been started																																																	
6	Reserved																																																		
7	Reserved																																																		
8	Local control	1 = DSU is in local control																																																	
9	Network control	1 = DSU is in network control																																																	
10	Ext1 active	1 = Control location Ext1 active																																																	
11	Ext2 active	1 = Control location Ext2 active																																																	
12	Charging	1 = Charging relay is closed																																																	
13	MCB	1 = MCB relay is closed																																																	
14...15	Reserved																																																		
	0000h...FFFFh	Status word 1.	1 = 1																																																

No.	Name/Value	Description	Def/FbEq16																																													
106.17	<i>Drive status word 2</i>	Drive status word 2. This parameter is read-only.	-																																													
<table border="1"> <thead> <tr> <th>Bit</th> <th>Name</th> <th>Description</th> </tr> </thead> <tbody> <tr><td>0</td><td>Reserved</td><td></td></tr> <tr><td>1</td><td>Reserved</td><td></td></tr> <tr><td>2</td><td>Reserved</td><td></td></tr> <tr><td>3</td><td>Reserved</td><td></td></tr> <tr><td>4</td><td>Reserved</td><td></td></tr> <tr><td>5</td><td>Reserved</td><td></td></tr> <tr><td>6</td><td>Reserved</td><td></td></tr> <tr><td>7</td><td>Reserved</td><td></td></tr> <tr><td>8</td><td>Reserved</td><td></td></tr> <tr><td>9</td><td>Reserved</td><td></td></tr> <tr><td>10</td><td>Reserved</td><td></td></tr> <tr><td>11</td><td>Reserved</td><td></td></tr> <tr><td>12</td><td>Reduced run</td><td>1 = Reduced run active (see section <i>Reduced run function</i> on page 38)</td></tr> <tr><td>13...15</td><td>Reserved</td><td></td></tr> </tbody> </table>				Bit	Name	Description	0	Reserved		1	Reserved		2	Reserved		3	Reserved		4	Reserved		5	Reserved		6	Reserved		7	Reserved		8	Reserved		9	Reserved		10	Reserved		11	Reserved		12	Reduced run	1 = Reduced run active (see section <i>Reduced run function</i> on page 38)	13...15	Reserved	
Bit	Name	Description																																														
0	Reserved																																															
1	Reserved																																															
2	Reserved																																															
3	Reserved																																															
4	Reserved																																															
5	Reserved																																															
6	Reserved																																															
7	Reserved																																															
8	Reserved																																															
9	Reserved																																															
10	Reserved																																															
11	Reserved																																															
12	Reduced run	1 = Reduced run active (see section <i>Reduced run function</i> on page 38)																																														
13...15	Reserved																																															
	0000h...FFFFh	Drive status word 2.	1 = 1																																													
106.18	<i>Start inhibit status word</i>	Start inhibit status word.	-																																													
<table border="1"> <thead> <tr> <th>Bit</th> <th>Name</th> </tr> </thead> <tbody> <tr><td>0</td><td>Not ready run</td></tr> <tr><td>1</td><td>Ctrl location changed</td></tr> <tr><td>2</td><td>SSW inhibit</td></tr> <tr><td>3</td><td>Fault reset</td></tr> <tr><td>4</td><td>Lost start enable</td></tr> <tr><td>5</td><td>Lost run enable</td></tr> <tr><td>6</td><td>Reserved</td></tr> <tr><td>7</td><td>Reserved</td></tr> <tr><td>8</td><td>Reserved</td></tr> <tr><td>9</td><td>Charging overload</td></tr> <tr><td>10</td><td>Reserved</td></tr> <tr><td>11</td><td>Reserved</td></tr> <tr><td>12</td><td>Em Off2</td></tr> <tr><td>13</td><td>Em Off3</td></tr> <tr><td>14</td><td>Auto reset inhibit</td></tr> <tr><td>15</td><td>Reserved</td></tr> </tbody> </table>				Bit	Name	0	Not ready run	1	Ctrl location changed	2	SSW inhibit	3	Fault reset	4	Lost start enable	5	Lost run enable	6	Reserved	7	Reserved	8	Reserved	9	Charging overload	10	Reserved	11	Reserved	12	Em Off2	13	Em Off3	14	Auto reset inhibit	15	Reserved											
Bit	Name																																															
0	Not ready run																																															
1	Ctrl location changed																																															
2	SSW inhibit																																															
3	Fault reset																																															
4	Lost start enable																																															
5	Lost run enable																																															
6	Reserved																																															
7	Reserved																																															
8	Reserved																																															
9	Charging overload																																															
10	Reserved																																															
11	Reserved																																															
12	Em Off2																																															
13	Em Off3																																															
14	Auto reset inhibit																																															
15	Reserved																																															
	0000h...FFFFh	Start inhibit status word.	1 = 1																																													

50 Parameters

No.	Name/Value	Description	Def/FbEq16																					
106.25	<i>Drive inhibit status word 2</i>	Drive inhibit status word 2. This word specifies the source of the inhibiting signal that is preventing the unit from starting. See also parameters <i>106.18 Start inhibit status word</i> , and <i>106.16 Drive status word 1</i> , bit 1. This parameter is read-only.	-																					
<table border="1"> <thead> <tr> <th>Bit</th> <th>Name</th> <th>Description</th> </tr> </thead> <tbody> <tr> <td>0</td> <td>Follower drive</td> <td>1 = A follower is preventing the master from starting.</td> </tr> <tr> <td>1</td> <td>Application</td> <td>1 = The application program is preventing the drive from starting.</td> </tr> <tr> <td>2</td> <td>Aux. power failure</td> <td>1 = A control unit auxiliary power failure is preventing the drive from starting.</td> </tr> <tr> <td>3</td> <td>Reserved</td> <td></td> </tr> <tr> <td>4</td> <td>Ref source parametrization</td> <td>1 = A reference source parametrization conflict is preventing the drive from starting.</td> </tr> <tr> <td>5...15</td> <td>Reserved</td> <td></td> </tr> </tbody> </table>				Bit	Name	Description	0	Follower drive	1 = A follower is preventing the master from starting.	1	Application	1 = The application program is preventing the drive from starting.	2	Aux. power failure	1 = A control unit auxiliary power failure is preventing the drive from starting.	3	Reserved		4	Ref source parametrization	1 = A reference source parametrization conflict is preventing the drive from starting.	5...15	Reserved	
Bit	Name	Description																						
0	Follower drive	1 = A follower is preventing the master from starting.																						
1	Application	1 = The application program is preventing the drive from starting.																						
2	Aux. power failure	1 = A control unit auxiliary power failure is preventing the drive from starting.																						
3	Reserved																							
4	Ref source parametrization	1 = A reference source parametrization conflict is preventing the drive from starting.																						
5...15	Reserved																							
	0000h...FFFFh	Drive inhibit status word 2.	1 = 1																					
106.30	<i>MSW bit 11 sel</i>	Selects a binary source whose status is transmitted as bit 11 of <i>106.11 Main status word</i> .	<i>Ext ctrl loc</i>																					
	False	0.	1																					
	True	1.	2																					
	Ext ctrl loc	External control location selected.	3																					
	<i>Other [bit]</i>	A specific bit in another parameter.	3																					
106.31	<i>MSW bit 12 sel</i>	Selects a binary source whose status is transmitted as bit 12 of <i>106.11 Main status word</i> .	<i>False</i>																					
	False	0.	1																					
	True	1.	2																					
	<i>Other [bit]</i>	A specific bit in another parameter.	3																					
106.32	<i>MSW bit 13 sel</i>	Selects a binary source whose status is transmitted as bit 13 of <i>106.11 Main status word</i> .	<i>False</i>																					
	False	0.	1																					
	True	1.	2																					
	<i>Other [bit]</i>	A specific bit in another parameter.	3																					
106.33	<i>MSW bit 15 sel</i>	Selects a binary source whose status is transmitted as bit 15 of <i>106.11 Main status word</i> .	<i>False</i>																					
	False	0.	1																					
	True	1.	2																					
	<i>Other [bit]</i>	A specific bit in another parameter.	3																					

No.	Name/Value	Description	Def/FbEq16																																																			
106.50	<i>User status word 1</i>	User status word 1.																																																				
		<table border="1"> <thead> <tr> <th>Bit</th> <th>Name</th> <th>Description</th> </tr> </thead> <tbody> <tr><td>0</td><td>User status bit 0</td><td>See 106.60 User status word 1 bit 0 sel.</td></tr> <tr><td>1</td><td>User status bit 1</td><td>See 106.61 User status word 1 bit 1 sel.</td></tr> <tr><td>2</td><td>User status bit 2</td><td>See 106.62 User status word 1 bit 2 sel.</td></tr> <tr><td>3</td><td>User status bit 3</td><td>See 106.63 User status word 1 bit 3 sel.</td></tr> <tr><td>4</td><td>User status bit 4</td><td>See 106.64 User status word 1 bit 4 sel.</td></tr> <tr><td>5</td><td>User status bit 5</td><td>See 106.65 User status word 1 bit 5 sel.</td></tr> <tr><td>6</td><td>User status bit 6</td><td>See 106.66 User status word 1 bit 6 sel.</td></tr> <tr><td>7</td><td>User status bit 7</td><td>See 106.67 User status word 1 bit 7 sel.</td></tr> <tr><td>8</td><td>User status bit 8</td><td>See 106.68 User status word 1 bit 8 sel.</td></tr> <tr><td>9</td><td>User status bit 9</td><td>See 106.69 User status word 1 bit 9 sel.</td></tr> <tr><td>10</td><td>User status bit 10</td><td>See 106.70 User status word 1 bit 10 sel.</td></tr> <tr><td>11</td><td>User status bit 11</td><td>See 106.71 User status word 1 bit 11 sel.</td></tr> <tr><td>12</td><td>User status bit 12</td><td>See 106.72 User status word 1 bit 12 sel.</td></tr> <tr><td>13</td><td>User status bit 13</td><td>See 106.73 User status word 1 bit 13 sel.</td></tr> <tr><td>14</td><td>User status bit 14</td><td>See 106.74 User status word 1 bit 14 sel.</td></tr> <tr><td>15</td><td>User status bit 15</td><td>See 106.75 User status word 1 bit 15 sel.</td></tr> </tbody> </table>	Bit	Name	Description	0	User status bit 0	See 106.60 User status word 1 bit 0 sel.	1	User status bit 1	See 106.61 User status word 1 bit 1 sel.	2	User status bit 2	See 106.62 User status word 1 bit 2 sel.	3	User status bit 3	See 106.63 User status word 1 bit 3 sel.	4	User status bit 4	See 106.64 User status word 1 bit 4 sel.	5	User status bit 5	See 106.65 User status word 1 bit 5 sel.	6	User status bit 6	See 106.66 User status word 1 bit 6 sel.	7	User status bit 7	See 106.67 User status word 1 bit 7 sel.	8	User status bit 8	See 106.68 User status word 1 bit 8 sel.	9	User status bit 9	See 106.69 User status word 1 bit 9 sel.	10	User status bit 10	See 106.70 User status word 1 bit 10 sel.	11	User status bit 11	See 106.71 User status word 1 bit 11 sel.	12	User status bit 12	See 106.72 User status word 1 bit 12 sel.	13	User status bit 13	See 106.73 User status word 1 bit 13 sel.	14	User status bit 14	See 106.74 User status word 1 bit 14 sel.	15	User status bit 15	See 106.75 User status word 1 bit 15 sel.	
Bit	Name	Description																																																				
0	User status bit 0	See 106.60 User status word 1 bit 0 sel.																																																				
1	User status bit 1	See 106.61 User status word 1 bit 1 sel.																																																				
2	User status bit 2	See 106.62 User status word 1 bit 2 sel.																																																				
3	User status bit 3	See 106.63 User status word 1 bit 3 sel.																																																				
4	User status bit 4	See 106.64 User status word 1 bit 4 sel.																																																				
5	User status bit 5	See 106.65 User status word 1 bit 5 sel.																																																				
6	User status bit 6	See 106.66 User status word 1 bit 6 sel.																																																				
7	User status bit 7	See 106.67 User status word 1 bit 7 sel.																																																				
8	User status bit 8	See 106.68 User status word 1 bit 8 sel.																																																				
9	User status bit 9	See 106.69 User status word 1 bit 9 sel.																																																				
10	User status bit 10	See 106.70 User status word 1 bit 10 sel.																																																				
11	User status bit 11	See 106.71 User status word 1 bit 11 sel.																																																				
12	User status bit 12	See 106.72 User status word 1 bit 12 sel.																																																				
13	User status bit 13	See 106.73 User status word 1 bit 13 sel.																																																				
14	User status bit 14	See 106.74 User status word 1 bit 14 sel.																																																				
15	User status bit 15	See 106.75 User status word 1 bit 15 sel.																																																				
	0000h...FFFFh	User-defined status word.	1 = 1																																																			
106.60	<i>User status word 1 bit 0 sel</i>	Selects a binary source whose status is transmitted as bit 0 of 106.50 User status word 1.	<i>False</i>																																																			
	False	0.	1																																																			
	True	1.	2																																																			
	<i>Other [bit]</i>	A specific bit in another parameter.	3																																																			
106.61	<i>User status word 1 bit 1 sel</i>	Selects a binary source whose status is transmitted as bit 1 of 106.50 User status word 1.	<i>False</i>																																																			
	False	0.	1																																																			
	True	1.	2																																																			
	<i>Other [bit]</i>	A specific bit in another parameter.	3																																																			
106.62	<i>User status word 1 bit 2 sel</i>	Selects a binary source whose status is transmitted as bit 2 of 106.50 User status word 1.	<i>False</i>																																																			
	False	0.	1																																																			
	True	1.	2																																																			
	<i>Other [bit]</i>	A specific bit in another parameter.	3																																																			
106.63	<i>User status word 1 bit 3 sel</i>	Selects a binary source whose status is transmitted as bit 3 of 106.50 User status word 1.	<i>False</i>																																																			
	False	0.	1																																																			
	True	1.	2																																																			
	<i>Other [bit]</i>	A specific bit in another parameter.	3																																																			
106.64	<i>User status word 1 bit 4 sel</i>	Selects a binary source whose status is transmitted as bit 4 of 106.50 User status word 1.	<i>False</i>																																																			
	False	0.	1																																																			
	True	1.	2																																																			
	<i>Other [bit]</i>	A specific bit in another parameter.	3																																																			
106.65	<i>User status word 1 bit 5 sel</i>	Selects a binary source whose status is transmitted as bit 5 of 106.50 User status word 1.	<i>False</i>																																																			
	False	0.	1																																																			
	True	1.	2																																																			
	<i>Other [bit]</i>	A specific bit in another parameter.	3																																																			

52 Parameters

No.	Name/Value	Description	Def/FbEq16
106.66	<i>User status word 1 bit 6 sel</i>	Selects a binary source whose status is transmitted as bit 6 of <i>106.50 User status word 1</i> .	<i>False</i>
	False	0.	1
	True	1.	2
	<i>Other [bit]</i>	A specific bit in another parameter.	3
106.67	<i>User status word 1 bit 7 sel</i>	Selects a binary source whose status is transmitted as bit 7 of <i>106.50 User status word 1</i> .	<i>False</i>
	False	0.	1
	True	1.	2
	<i>Other [bit]</i>	A specific bit in another parameter.	3
106.68	<i>User status word 1 bit 8 sel</i>	Selects a binary source whose status is transmitted as bit 8 of <i>106.50 User status word 1</i> .	<i>False</i>
	False	0.	1
	True	1.	2
	<i>Other [bit]</i>	A specific bit in another parameter.	3
106.69	<i>User status word 1 bit 9 sel</i>	Selects a binary source whose status is transmitted as bit 9 of <i>106.50 User status word 1</i> .	<i>False</i>
	False	0.	1
	True	1.	2
	<i>Other [bit]</i>	A specific bit in another parameter.	3
106.70	<i>User status word 1 bit 10 sel</i>	Selects a binary source whose status is transmitted as bit 10 of <i>106.50 User status word 1</i> .	<i>False</i>
	False	0.	1
	True	1.	2
	<i>Other [bit]</i>	A specific bit in another parameter.	3
106.71	<i>User status word 1 bit 11 sel</i>	Selects a binary source whose status is transmitted as bit 11 of <i>106.50 User status word 1</i> .	<i>False</i>
	False	0.	1
	True	1.	2
	<i>Other [bit]</i>	A specific bit in another parameter.	3
106.72	<i>User status word 1 bit 12 sel</i>	Selects a binary source whose status is transmitted as bit 12 of <i>106.50 User status word 1</i> .	<i>False</i>
	False	0.	1
	True	1.	2
	<i>Other [bit]</i>	A specific bit in another parameter.	3
106.73	<i>User status word 1 bit 13 sel</i>	Selects a binary source whose status is transmitted as bit 13 of <i>106.50 User status word 1</i> .	<i>False</i>
	False	0.	1
	True	1.	2
	<i>Other [bit]</i>	A specific bit in another parameter.	3
106.74	<i>User status word 1 bit 14 sel</i>	Selects a binary source whose status is transmitted as bit 14 of <i>106.50 User status word 1</i> .	<i>False</i>
	False	0.	1
	True	1.	2
	<i>Other [bit]</i>	A specific bit in another parameter.	3
106.75	<i>User status word 1 bit 15 sel</i>	Selects a binary source whose status is transmitted as bit 15 of <i>106.50 User status word 1</i> .	<i>False</i>
	False	0.	1
	True	1.	2
	<i>Other [bit]</i>	A specific bit in another parameter.	3

No.	Name/Value	Description	Def/FbEq16																		
107 System info		Hardware and firmware information. All parameters in this group are read-only.																			
107.03	<i>Drive rating id</i>	<u>DxT modules only</u> : Type of the diode supply unit.	-																		
107.04	<i>Firmware name</i>	Firmware identification.	-																		
107.05	<i>Firmware version</i>	Version number of the firmware.	-																		
107.06	<i>Loading package name</i>	Name of the firmware loading package.	-																		
107.07	<i>Loading package version</i>	Version number of the firmware loading package.	-																		
107.08	<i>Bootloader version</i>	Version number of the firmware bootloader.	-																		
107.11	<i>Cpu usage</i>	Microprocessor load in percent.	-																		
	0 ... 100%	Microprocessor load.	1 = 1%																		
107.13	<i>PU logic version number</i>	<u>DxT modules only</u> : The version number of the power unit FPGA logic.	-																		
110 Standard DI, RO		Configuration of digital inputs and relay outputs.																			
110.01	<i>DI status</i>	Status of digital inputs DI1L and DI6...DI1. Bits 0...5 reflect the status of DI1...DI6; bit 15 reflects the status of the DI1L input.	-																		
	0000h...FFFFh	Status of digital inputs.	1 = 1																		
110.02	<i>DI delayed status</i>	Status of digital inputs DI1L and DI6...DI1 after any activation/deactivation delays. Bits 0...5 reflect the delayed status of DI1...DI6; bit 15 reflects the delayed status of the DI1L input.	-																		
	0000h...FFFFh	Delayed status of digital inputs.	1 = 1																		
110.03	<i>DI force selection</i>	Defines how the true readings of the digital inputs can be overridden for eg. testing purposes. A bit in parameter 110.04 DI force data is provided for each digital input, and its value is applied whenever the corresponding bit in this parameter is 1.	0000h																		
		<table border="1"> <thead> <tr> <th>Bit</th> <th>Value</th> </tr> </thead> <tbody> <tr> <td>0</td> <td>1 = Force DI1 to value of bit 0 of parameter 110.04 DI force data.</td> </tr> <tr> <td>1</td> <td>1 = Force DI2 to value of bit 1 of parameter 110.04 DI force data.</td> </tr> <tr> <td>2</td> <td>1 = Force DI3 to value of bit 2 of parameter 110.04 DI force data.</td> </tr> <tr> <td>3</td> <td>1 = Force DI4 to value of bit 3 of parameter 110.04 DI force data.</td> </tr> <tr> <td>4</td> <td>1 = Force DI5 to value of bit 4 of parameter 110.04 DI force data.</td> </tr> <tr> <td>5</td> <td>1 = Force DI6 to value of bit 5 of parameter 110.04 DI force data.</td> </tr> <tr> <td>6...14</td> <td>Reserved</td> </tr> <tr> <td>15</td> <td>1 = Force DI1L to value of bit 15 of parameter 110.04 DI force data.</td> </tr> </tbody> </table>	Bit	Value	0	1 = Force DI1 to value of bit 0 of parameter 110.04 DI force data .	1	1 = Force DI2 to value of bit 1 of parameter 110.04 DI force data .	2	1 = Force DI3 to value of bit 2 of parameter 110.04 DI force data .	3	1 = Force DI4 to value of bit 3 of parameter 110.04 DI force data .	4	1 = Force DI5 to value of bit 4 of parameter 110.04 DI force data .	5	1 = Force DI6 to value of bit 5 of parameter 110.04 DI force data .	6...14	Reserved	15	1 = Force DI1L to value of bit 15 of parameter 110.04 DI force data .	
Bit	Value																				
0	1 = Force DI1 to value of bit 0 of parameter 110.04 DI force data .																				
1	1 = Force DI2 to value of bit 1 of parameter 110.04 DI force data .																				
2	1 = Force DI3 to value of bit 2 of parameter 110.04 DI force data .																				
3	1 = Force DI4 to value of bit 3 of parameter 110.04 DI force data .																				
4	1 = Force DI5 to value of bit 4 of parameter 110.04 DI force data .																				
5	1 = Force DI6 to value of bit 5 of parameter 110.04 DI force data .																				
6...14	Reserved																				
15	1 = Force DI1L to value of bit 15 of parameter 110.04 DI force data .																				
	0000h...FFFFh	Status of digital inputs.	1 = 1																		
110.04	<i>DI force data</i>	Defines and contains the values of digital inputs that are used instead of the true readings if selected in parameter 110.03 DI force selection . Bit 0 is the forced value for DI1.	0000h																		
	0000h...FFFFh	Forced values of digital inputs.	1 = 1																		

54 Parameters

No.	Name/Value	Description	Def/FbEq16
110.05	DI1 ON delay	Defines the activation delay for digital input DI1.	0.0 s
<p style="text-align: center;"> t_{On} 110.05 DI1 ON delay t_{Off} 110.06 DI1 OFF delay </p>			
	0.0 ... 3000.0 s	Activation delay for DI1.	10 = 1 s
110.06	DI1 OFF delay	Defines the deactivation delay for digital input DI1. See parameter 110.05 DI1 ON delay .	0.0 s
	0.0 ... 3000.0 s	Deactivation delay for DI1.	10 = 1 s
110.07	DI2 ON delay	Defines the activation delay for digital input DI2.	0.0 s
<p style="text-align: center;"> t_{On} 110.07 DI2 ON delay t_{Off} 110.08 DI2 OFF delay </p>			
	0.0 ... 3000.0 s	Activation delay for DI2.	10 = 1 s
110.08	DI2 OFF delay	Defines the deactivation delay for digital input DI2. See parameter 110.07 DI2 ON delay .	0.0 s
	0.0 ... 3000.0 s	Deactivation delay for DI2.	10 = 1 s
110.09	DI3 ON delay	Defines the activation delay for digital input DI3.	0.3 s
<p style="text-align: center;"> t_{On} 110.09 DI3 ON delay t_{Off} 110.10 DI3 OFF delay </p>			
	0.0 ... 3000.0 s	Activation delay for DI3.	10 = 1 s
110.10	DI3 OFF delay	Defines the deactivation delay for digital input DI3. See parameter 110.09 DI3 ON delay .	0.0 s
	0.0 ... 3000.0 s	Deactivation delay for DI3.	10 = 1 s

No.	Name/Value	Description	Def/FbEq16
110.11	DI4 ON delay	Defines the activation delay for digital input DI4.	0.0 s
<p> t_{On} 110.11 DI4 ON delay t_{Off} 110.12 DI4 OFF delay </p>			
	0.0 ... 3000.0 s	Activation delay for DI4.	10 = 1 s
110.12	DI4 OFF delay	Defines the deactivation delay for digital input DI4. See parameter 110.11 DI4 ON delay .	0.0 s
	0.0 ... 3000.0 s	Deactivation delay for DI4.	10 = 1 s
110.13	DI5 ON delay	Defines the activation delay for digital input DI5.	0.0 s
<p> t_{On} 110.13 DI5 ON delay t_{Off} 110.14 DI4 OFF delay </p>			
	0.0 ... 3000.0 s	Activation delay for DI5.	10 = 1 s
110.14	DI5 OFF delay	Defines the deactivation delay for digital input DI5. See parameter 110.13 DI5 ON delay .	0.0 s
	0.0 ... 3000.0 s	Deactivation delay for DI5.	10 = 1 s
110.15	DI6 ON delay	Defines the activation delay for digital input DI6.	0.0 s
<p> t_{On} 110.15 DI6 ON delay t_{Off} 110.16 DI6 OFF delay </p>			
	0.0 ... 3000.0 s	Activation delay for DI6.	10 = 1 s
110.16	DI6 OFF delay	Defines the deactivation delay for digital input DI6. See parameter 110.15 DI6 ON delay .	0.0 s
	0.0 ... 3000.0 s	Deactivation delay for DI6.	10 = 1 s

No.	Name/Value	Description	Def/FbEq16
110.21	<i>RO status</i>	Shows the status of relay outputs RO8...RO1. Example: 00000001 = RO1 is energized, RO2...RO8 are de-energized.	
	0000h...FFFFh	Status of relay outputs.	1 = 1
110.24	<i>RO1 source</i>	Selects a signal to be connected to relay output RO1. <u>DxD modules only:</u> Note: This parameter is write-protected if parameter 120.30 External charge enable is set to <i>Yes</i> . Note: For the cabinet-installed supply units, check the delivery-specific use from the delivery-specific circuit diagrams. Do not change the setting if relay output is in use and connected already.	<i>Running</i>
	Not energized	Relay output is not energized.	0
	Energized	Relay output is energized.	1
	Ready	Bit 0 of 106.11 Main status word (see page 48). Relay is energized when the supply unit is ready.	2
	Started	Bit 4 of 106.16 Drive status word 1 (see page 48). Relay is energized when the supply unit is started.	3
	Running	Bit 1 of 106.11 Main status word (see page 48). Relay is energized when the supply unit is running.	4
	Warning	Bit 7 of 106.11 Main status word (see page 48). Relay is energized when a warning is active.	5
	Fault	Bit 3 of 106.11 Main status word (see page 48). Relay is energized when a fault is active.	6
	MCB	Bit 13 of 106.16 Drive status word 1 (see page 48). Relay is energized when MCB closing command is given.	7
	Charging	Bit 14 of 106.16 Drive status word 1 (see page 48). Relay is energized when external charging is charging the DC link.	8
	Fault (-1)	Inverted bit 3 of 106.11 Main status word (see page 48). Relay is de-energized when a fault is active.	9
	<i>Other [bit]</i>	A specific bit in another parameter.	
110.25	<i>RO1 ON delay</i>	Defines the activation delay for relay output RO1.	0.0 s
<p style="text-align: center;"> t_{On} 110.25 RO1 ON delay t_{Off} 110.26 RO1 OFF delay </p>			
	0.0 ... 3000.0 s	Activation delay for RO1.	10 = 1 s
110.26	<i>RO1 OFF delay</i>	Defines the deactivation delay for relay output RO1. See parameter 110.25 RO1 ON delay .	0.0 s
	0.0 ... 3000.0 s	Deactivation delay for RO1.	10 = 1 s

No.	Name/Value	Description	Def/FbEq16
110.27	RO2 source	Selects a supply unit signal to be connected to relay output RO2. For the available selections, see parameter 110.24 RO1 source. Note: For the cabinet-installed supply units, check the delivery-specific use from the delivery-specific circuit diagrams. Do not change the setting if relay output is in use and connected already.	Fault (-1)
110.28	RO2 ON delay	Defines the activation delay for relay output RO2.	0.0 s
<p style="text-align: center;"> t_{On} 110.28 RO2 ON delay t_{Off} 110.29 RO2 OFF delay </p>			
	0.0 ... 3000.0 s	Activation delay for RO2.	10 = 1 s
110.29	RO2 OFF delay	Defines the deactivation delay for relay output RO2. See parameter 110.28 RO2 ON delay.	0.0 s
	0.0 ... 3000.0 s	Deactivation delay for RO2.	10 = 1 s
110.30	RO3 source	Selects a signal to be connected to relay output RO3. For the available selections, see parameter 110.24 RO1 source. DxD modules only: Note: This parameter is write-protected if parameter 120.30 External charge enable is set to Yes. Note: For the cabinet-installed supply units, check the delivery-specific use from the delivery-specific circuit diagrams. Do not change the setting if relay output is in use and connected already.	MCB
110.31	RO3 ON delay	Defines the activation delay for relay output RO3.	0.0 s
<p style="text-align: center;"> t_{On} 110.31 RO3 ON delay t_{Off} 110.32 RO3 OFF delay </p>			
	0.0 ... 3000.0 s	Activation delay for RO3.	10 = 1 s
110.32	RO3 OFF delay	Defines the deactivation delay for relay output RO3. See parameter 110.31 RO3 ON delay.	0.0 s
	0.0 ... 3000.0 s	Deactivation delay for RO3.	10 = 1 s
110.51	DI filter time	Defines a filtering time for parameter 110.01 DI status.	10.0 ms
	0.3 ... 100.0 ms	Filtering time for 110.01.	10 = 1 ms

No.	Name/Value	Description	Def/FbEq16																					
110.99	<i>RO/DIO control word</i>	Storage parameter for controlling the relay outputs and digital input/outputs. To control the relay outputs (RO) and the digital input/outputs (DIO), send a control word with the bit assignments shown below as Modbus I/O data. Set the target selection parameter of that particular data. In the source selection parameter of the desired output, select the appropriate bit of this word.	0000h																					
<table border="1"> <thead> <tr> <th>Bit</th> <th>Name</th> <th>Description</th> </tr> </thead> <tbody> <tr> <td>0</td> <td>RO1</td> <td rowspan="3">Source bits for relay outputs RO1...RO3 (see parameters 110.24, 110.27 and 110.30).</td> </tr> <tr> <td>1</td> <td>RO2</td> </tr> <tr> <td>2</td> <td>RO3</td> </tr> <tr> <td>3...7</td> <td>Reserved</td> <td></td> </tr> <tr> <td>8</td> <td>DIO1</td> <td rowspan="2">Source bits for digital input/outputs DIO1...DIO3 (see parameters 111.06 and 111.10).</td> </tr> <tr> <td>9</td> <td>DIO2</td> </tr> <tr> <td>10...15</td> <td>Reserved</td> <td></td> </tr> </tbody> </table>				Bit	Name	Description	0	RO1	Source bits for relay outputs RO1...RO3 (see parameters 110.24 , 110.27 and 110.30).	1	RO2	2	RO3	3...7	Reserved		8	DIO1	Source bits for digital input/outputs DIO1...DIO3 (see parameters 111.06 and 111.10).	9	DIO2	10...15	Reserved	
Bit	Name	Description																						
0	RO1	Source bits for relay outputs RO1...RO3 (see parameters 110.24 , 110.27 and 110.30).																						
1	RO2																							
2	RO3																							
3...7	Reserved																							
8	DIO1	Source bits for digital input/outputs DIO1...DIO3 (see parameters 111.06 and 111.10).																						
9	DIO2																							
10...15	Reserved																							
0000h...FFFFh		RO/DIO control word.	1 = 1																					
111 Standard DIO, FI, FO		Configuration of digital input/outputs and frequency inputs.																						
111.01	<i>DIO status</i>	Status of digital input/outputs DIO8...DIO1. Example: 0000001001 = DIO1 and DIO4 are on, the remainder are off.	-																					
0000h...FFFFh		Status of digital input/outputs.	1 = 1																					
111.02	<i>DIO delayed status</i>	Status of digital input/outputs DIO8...DIO1 after activation/deactivation delays. Bit 0 reflects the delayed status of DIO1.	-																					
0000h...FFFFh		Delayed status of digital input/outputs.	1 = 1																					
111.05	<i>DIO1 function</i>	Selects whether DIO1 is used as a digital output or input.	<i>Output</i>																					
Output		DIO1 is used as a digital output.	0																					
Input		DIO1 is used as a digital input.	1																					
Freq		DIO1 is used as a frequency input.	2																					
111.06	<i>DIO1 output source</i>	Selects a signal to be connected to digital input/output DIO1 when parameter 111.05 DIO1 function is set to <i>Output</i> .	<i>Not energized</i>																					
Not energized		Output is not energized.	0																					
Energized		Output is energized.	1																					
Ready		Bit 0 of 106.11 Main status word (see page 48). Output is energized when the supply unit is ready.	2																					
Started		Bit 4 of 106.16 Drive status word 1 (see page 48). Output is energized when the supply unit is started.	3																					
Running		Bit 1 of 106.11 Main status word (see page 48). Output is energized when the supply unit is running.	4																					
Warning		Bit 7 of 106.11 Main status word (see page 48). Output is energized when a warning is active.	5																					
Fault		Bit 3 of 106.11 Main status word (see page 48). Output is energized when a fault is active.	6																					
MCB		Bit 13 of 106.16 Drive status word 1 (see page 48). Output is energized when MCB closing command is given.	7																					
Charging		Bit 14 of 106.16 Drive status word 1 (see page 48). Output is energized when external charging is charging the DC link.	8																					
Fault (-1)		Inverted bit 3 of 106.11 Main status word (see page 48). Relay is de-energized when a fault is active.	9																					
<i>Other [bit]</i>		Source selection (see Terms and abbreviations on page 41).	-																					

No.	Name/Value	Description	Def/FbEq16
111.07	<i>DIO1 ON delay</i>	Defines the activation delay for digital input/output DIO1 when parameter <i>111.05 DIO1 function</i> is set to <i>Output</i> .	0.0 s
<p style="text-align: center;">t_{On} <i>111.07 DIO1 ON delay</i> t_{Off} <i>111.08 DIO1 OFF delay</i></p>			
	0.0 ... 3000.0 s	Activation delay for DIO1 when set as an output.	10 = 1 s
111.08	<i>DIO1 OFF delay</i>	Defines the deactivation delay for digital input/output DIO1 when parameter <i>111.05 DIO1 function</i> is set to <i>Output</i> . See parameter <i>111.07 DIO1 ON delay</i> .	0.0 s
	0.0 ... 3000.0 s	Deactivation delay for DIO1 when set as an output.	10 = 1 s
111.09	<i>DIO2 function</i>	Selects whether DIO2 is used as a digital output or input.	<i>Output</i>
	Output	DIO2 is used as a digital output.	0
	Input	DIO2 is used as a digital input.	1
	Freq	Reserved.	2
111.10	<i>DIO2 output source</i>	Selects a supply unit signal to be connected to digital input/output DIO2 when parameter <i>111.09 DIO2 function</i> is set to <i>Output</i> . For the available selections, see parameter <i>111.06 DIO1 output source</i> .	<i>Not energized</i>
111.11	<i>DIO2 ON delay</i>	Defines the activation delay for digital input/output DIO2 when parameter <i>111.09 DIO2 function</i> is set to <i>Output</i> .	0.0 s
<p style="text-align: center;">t_{On} <i>111.11 DIO2 ON delay</i> t_{Off} <i>111.12 DIO2 OFF delay</i></p>			
	0.0 ... 3000.0 s	Activation delay for DIO2 when set as an output.	10 = 1 s
111.12	<i>DIO2 OFF delay</i>	Defines the deactivation delay for digital input/output DIO2 when parameter <i>111.09 DIO2 function</i> is set to <i>Output</i> . See parameter <i>111.11 DIO2 ON delay</i> .	0.0 s
	0.0 ... 3000.0 s	Deactivation delay for DIO2 when set as an output.	10 = 1 s
111.38	<i>Freq in 1 actual value</i>	Value of frequency input 1 before scaling. See parameter <i>111.42 Freq in 1 min</i> .	-
	0 ... 16000 Hz	Unscaled value of frequency input 1.	1 = 1 Hz

60 Parameters

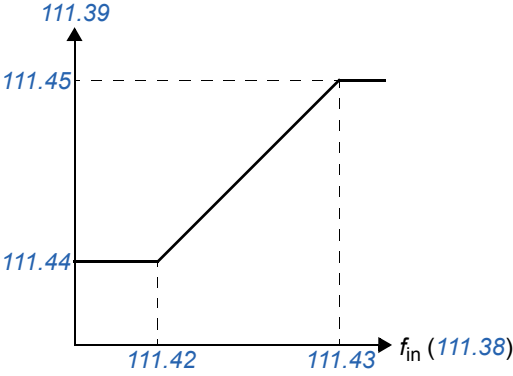
No.	Name/Value	Description	Def/FbEq16
111.39	<i>Freq in 1 scaled</i>	Value of frequency input 1 after scaling. See parameter 111.42 Freq in 1 min.	-
	-32768.000 ... 32767.000	Scaled value of frequency input 1.	1 = 1
111.42	<i>Freq in 1 min</i>	Defines the minimum input frequency for frequency input 1. The incoming frequency signal (111.38 Freq in 1 actual value) is scaled into an internal signal (111.39 Freq in 1 scaled) by parameters 111.42...111.45 as follows: 	0 Hz
	0 ... 16000 Hz	Minimum frequency of frequency input 1.	1 = 1 Hz
111.43	<i>Freq in 1 max</i>	Defines the maximum input frequency for frequency input 1. See parameter 111.42 Freq in 1 min.	16000 Hz
	0 ... 16000 Hz	Maximum frequency for frequency input 1.	1 = 1 Hz
111.44	<i>Freq in 1 at scaled min</i>	Defines the value that corresponds to the minimum input frequency defined by parameter 111.42 Freq in 1 min. See diagram at parameter 111.42 Freq in 1 min.	0.000
	-32768.000 ... 32767.000	Value corresponding to minimum of frequency input 1.	1 = 1
111.45	<i>Freq in 1 at scaled max</i>	Defines the value that corresponds to the maximum input frequency defined by parameter 111.43 Freq in 1 max. See diagram at parameter 111.42 Freq in 1 min.	1500.000
	-32768.000 ... 32767.000	Value corresponding to maximum of frequency input 1.	1 = 1
111.81	<i>DIO filter time</i>	Defines a filtering time for parameter 111.01 DIO status . The filtering time will only affect the DIOs that are in input mode.	10.0 ms
	0.3 ... 100.0 ms	Filtering time for 111.01 .	10 = 1 ms
112 Standard AI		Configuration of analog inputs.	
112.03	<i>AI supervision function</i>	Selects how the supply unit reacts when an analog input signal moves out of the minimum and/or maximum limits specified for the input. The inputs and the limits to be observed are selected by parameter 112.04 AI supervision selection .	<i>No action</i>
	No action	No action taken.	0
	Fault	The supply unit trips on 8E06 AI supervision .	1
	Warning	The supply unit generates an AE67 AI supervision warning.	2

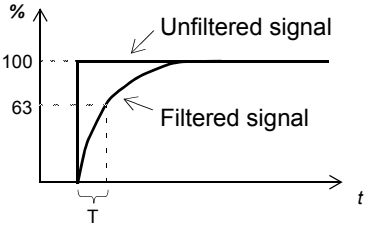
No.	Name/Value	Description	Def/FbEq16																		
112.04	<i>AI supervision selection</i>	Specifies the analog input limits to be supervised. See parameter 112.03 AI supervision function .	0000b																		
		<table border="1"> <thead> <tr> <th>Bit</th> <th>Name</th> <th>Description</th> </tr> </thead> <tbody> <tr> <td>0</td> <td>AI1 < MIN</td> <td>1 = Minimum limit supervision of AI1 active.</td> </tr> <tr> <td>1</td> <td>AI1 > MAX</td> <td>1 = Maximum limit supervision of AI1 active.</td> </tr> <tr> <td>2</td> <td>AI2 < MIN</td> <td>1 = Minimum limit supervision of AI2 active.</td> </tr> <tr> <td>3</td> <td>AI2 > MAX</td> <td>1 = Maximum limit supervision of AI2 active.</td> </tr> <tr> <td>4...15</td> <td>Reserved</td> <td></td> </tr> </tbody> </table>	Bit	Name	Description	0	AI1 < MIN	1 = Minimum limit supervision of AI1 active.	1	AI1 > MAX	1 = Maximum limit supervision of AI1 active.	2	AI2 < MIN	1 = Minimum limit supervision of AI2 active.	3	AI2 > MAX	1 = Maximum limit supervision of AI2 active.	4...15	Reserved		
Bit	Name	Description																			
0	AI1 < MIN	1 = Minimum limit supervision of AI1 active.																			
1	AI1 > MAX	1 = Maximum limit supervision of AI1 active.																			
2	AI2 < MIN	1 = Minimum limit supervision of AI2 active.																			
3	AI2 > MAX	1 = Maximum limit supervision of AI2 active.																			
4...15	Reserved																				
	0000b...1111b	Activation of analog input supervision.	1 = 1																		
112.11	<i>AI1 actual value</i>	Value of analog input AI1 in mA or V (depending on whether the input is set to current or voltage by jumper J1).	-																		
	-22.000 ... 22.000 mA or V	Value of analog input AI1.	1000 = 1 mA or V																		
112.12	<i>AI1 scaled value</i>	Value of analog input AI1 after scaling. See parameters 112.19 AI1 scaled at AI1 min and 112.20 AI1 scaled at AI1 max .	-																		
	-32768.000 ... 32767.000	Scaled value of analog input AI1.	1 = 1																		
112.15	<i>AI1 unit selection</i>	Selects the unit for readings and settings related to analog input 1.	V																		
	mA	Milliamperes.	10																		
	V	Volts.	2																		
112.16	<i>AI1 filter time</i>	<p>Defines the filter time constant for analog input AI1.</p>  <p>$O = I \times (1 - e^{-t/T})$</p> <p>I = filter input (step) O = filter output t = time T = filter time constant</p> <p>Note: The signal is also filtered due to the signal interface hardware (approximately 0.25 ms time constant). This cannot be changed by any parameter.</p>	0.000 s																		
	0.000 ... 30.000 s	Filter time constant.	1000 = 1 s																		
112.17	<i>AI1 min</i>	Defines the minimum value for analog input AI1. See the drawing at parameter 112.19 AI1 scaled at AI1 min .	0.000 V																		
	-22.000 ... 22.000 V or mA	Minimum value of AI1.	1000 = 1 V or mA																		
112.18	<i>AI1 max</i>	Defines the maximum value for analog input AI1. See the drawing at parameter 112.19 AI1 scaled at AI1 min .	20.000 V																		
	-22.000 ... 22.000 V or mA	Maximum value of AI1.	1000 = 1 V or mA																		

62 Parameters

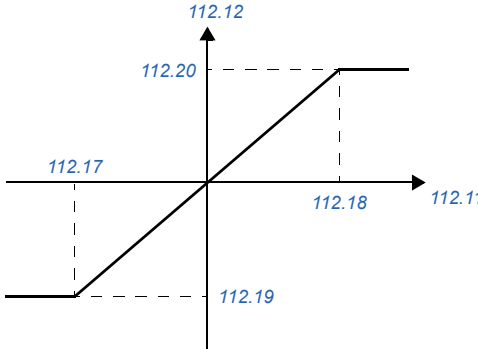
No.	Name/Value	Description	Def/FbEq16
112.19	<i>AI1 scaled at AI1 min</i>	Defines the real value of parameter <i>112.12 AI1 scaled value</i> that that corresponds to the minimum analog input AI1 value defined by parameter <i>112.17 AI1 min</i> . 	0.000
	-32768.000 ... 32768.000	Real value corresponding to minimum AI1 value.	1 = 1
112.20	<i>AI1 scaled at AI1 max</i>	Defines the real value of parameter <i>112.12 AI1 scaled value</i> that corresponds to the maximum analog input AI1 value defined by parameter <i>112.18 AI1 max</i> . See the drawing at parameter <i>112.19 AI1 scaled at AI1 min</i> .	1920.000
	-32768.000 ... 32767.000	Real value corresponding to maximum AI1 value.	1 = 1
112.21	<i>AI2 actual value</i>	Value of analog input AI2 in mA or V (depending on whether the input is set to current or voltage by jumper J2).	-
	-22.000 ... 22.000 mA or V	Value of analog input AI2.	1000 = 1 mA or V
112.22	<i>AI2 scaled value</i>	Value of analog input AI2 after scaling. See parameters <i>112.29 AI2 scaled at AI2 min</i> and <i>112.30 AI2 scaled at AI2 max</i> .	-
	-32768.000 ... 32767.000	Scaled value of analog input AI2.	1 = 1
112.25	<i>AI2 unit selection</i>	Selects the unit for readings and settings related to analog input 2.	<i>mA</i>
	mA	Milliamperes.	10
	V	Volts.	2
112.26	<i>AI2 filter time</i>	Defines the filter time constant for analog input AI2. See parameter <i>112.16 AI1 filter time</i> .	0.000 s
	0.000 ... 30.000 s	Filter time constant.	1000 = 1 s
112.27	<i>AI2 min</i>	Defines the minimum value for analog input AI2.	0.000 mA
	-22.000 ... 22.000 mA or V	Minimum value of AI2.	1000 = 1 mA or V
112.28	<i>AI2 max</i>	Defines the maximum value for analog input AI2.	20.000 mA
	-22.000 ... 22.000 mA or V	Maximum value of AI2.	1000 = 1 mA or V

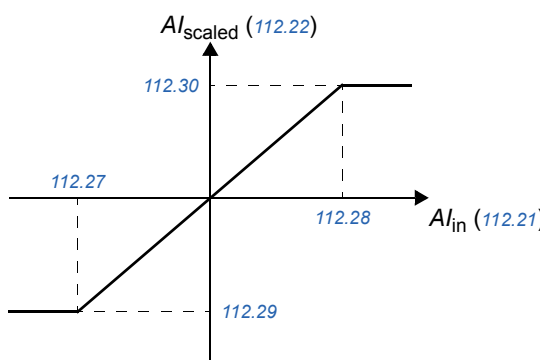
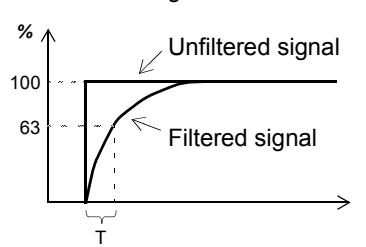
No.	Name/Value	Description	Def/FbEq16
112.29	<i>AI2 scaled at AI2 min</i>	Defines the real value of parameter 112.22 AI2 scaled value that corresponds to the minimum analog input AI2 value defined by parameter 112.27 AI2 min . 	0.000
	-32768.000 ...32767.000	Real value corresponding to minimum AI2 value.	1 = 1
112.30	<i>AI2 scaled at AI2 max</i>	Defines the real value of parameter 112.22 AI2 scaled value that corresponds to the maximum analog input AI2 value defined by parameter 112.28 AI2 max . See the drawing at parameter 112.29 AI2 scaled at AI2 min .	1920.000
	-32768.000 ... 32767.000	Real value corresponding to maximum AI2 value.	1 = 1
113 Standard AO		Configuration of analog outputs.	
113.11	<i>AO1 actual value</i>	Value of AO1 in mA.	-
	0.000 ... 22.000 mA	Value of AO1.	1000 = 1 mA
113.12	<i>AO1 source</i>	Selects a signal to be connected to analog output AO1.	<i>Zero</i>
	Zero	None.	0
	DC voltage	101.01 DC voltage	1
	AO1 data storage	113.91 AO1 data storage (page 65).	37
	AO2 data storage	113.92 AO2 data storage (page 65).	38
	Other	The value is taken from another parameter.	-
113.16	<i>AO1 filter time</i>	Defines the filtering time constant for analog output AO1.  $O = I \times (1 - e^{-t/T})$ I = filter input (step) O = filter output t = time T = filter time constant	0.100 s
	0.000 ... 30.000 s	Filter time constant.	1000 = 1 s

64 Parameters

No.	Name/Value	Description	Def/FbEq16
113.17	<i>AO1 source min</i>	<p>Defines the real value of the signal (selected by parameter 113.12 AO1 source) that corresponds to the minimum AO1 output value (defined by parameter 113.19 AO1 out at AO1 src min).</p> <p>The figure consists of two coordinate systems. The vertical axis for both is labeled I_{AO1} (mA) and has tick marks at 113.19 and 113.20. The horizontal axis is labeled 'Signal (real) selected by par. 113.12'. The top graph shows a horizontal line at 113.19 mA for signal values up to 113.17. At 113.17, the line rises linearly to 113.20 mA at signal value 113.18, and then remains constant at 113.20 mA for higher signal values. The bottom graph shows a horizontal line at 113.20 mA for signal values up to 113.18. At 113.18, the line falls linearly to 113.19 mA at signal value 113.17, and then remains constant at 113.19 mA for higher signal values.</p>	0.0
	-32768.0 ... 32767.0	Real signal value corresponding to minimum AO1 output value.	1 = 1
113.18	<i>AO1 source max</i>	<p>Defines the real value of the signal (selected by parameter 113.12 AO1 source) that corresponds to the maximum AO1 output value (defined by parameter 113.20 AO1 out at AO1 src max). See parameter 113.17 AO1 source min.</p>	100.0
	-32768.0 ... 32767.0	Real signal value corresponding to maximum AO1 output value.	1 = 1
113.19	<i>AO1 out at AO1 src min</i>	<p>Defines the minimum output value for analog output AO1. See also drawing at parameter 113.17 AO1 source min.</p>	4.000 mA
	0.000 ... 22.000 mA	Minimum AO1 output value.	1000 = 1 mA
113.20	<i>AO1 out at AO1 src max</i>	<p>Defines the maximum output value for analog output AO1. See also drawing at parameter 113.17 AO1 source min.</p>	20.000 mA
	0.000 ... 22.000 mA	Maximum AO1 output value.	1000 = 1 mA
113.21	<i>AO2 actual value</i>	Value of AO2 in mA.	-
	0.000 ... 22.000 mA	Value of AO2.	1000 = 1 mA
113.22	<i>AO2 source</i>	<p>Selects a signal to be connected to analog output AO2. For the selections, see parameter 113.12 AO1 source.</p>	Zero
113.26	<i>AO2 filter time</i>	<p>Defines the filtering time constant for analog output AO2. See parameter 113.16 AO1 filter time.</p>	0.100 s
	0.000 ... 30.000 s	Filter time constant.	1000 = 1 s

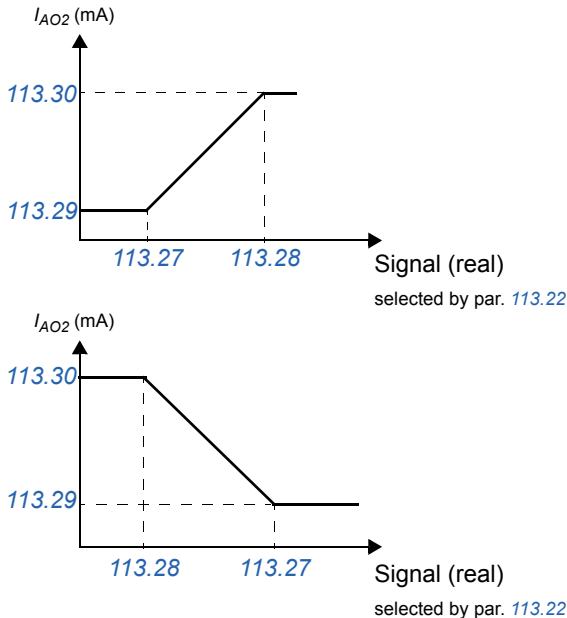
No.	Name/Value	Description	Def/FbEq16
113.27	<i>AO2 source min</i>	<p>Defines the real value of the signal (selected by parameter 113.22 AO2 source) that corresponds to the minimum AO2 output value (defined by parameter 113.29 AO2 out at AO2 src min).</p> 	0.0
	-32768.0 ... 32767.0	Real signal value corresponding to minimum AO2 output value.	1 = 1
113.28	<i>AO2 source max</i>	<p>Defines the real value of the signal (selected by parameter 113.22 AO2 source) that corresponds to the maximum AO2 output value (defined by parameter 113.30 AO2 out at AO2 src max). See parameter 113.27 AO2 source min.</p>	100.0
	-32768.0 ... 32767.0	Real signal value corresponding to maximum AO2 output value.	1 = 1
113.29	<i>AO2 out at AO2 src min</i>	<p>Defines the minimum output value for analog output AO2. See also drawing at parameter 113.27 AO2 source min.</p>	4.000 mA
	0.000 ... 22.000 mA	Minimum AO2 output value.	1000 = 1 mA
113.30	<i>AO2 out at AO2 src max</i>	<p>Defines the maximum output value for analog output AO2. See also drawing at parameter 113.27 AO2 source min.</p>	20.000 mA
	0.000 ... 22.000 mA	Maximum AO2 output value.	1000 = 1 mA
113.91	<i>AO1 data storage</i>	<p>Storage parameter for controlling analog output AO1 eg. through fieldbus. In 113.12 AO1 source, select AO1 data storage. Then set this parameter as the target of the incoming value data.</p>	0.00
	-327.68 ... 327.67	Storage parameter for AO1.	100 = 1
113.92	<i>AO2 data storage</i>	<p>Storage parameter for controlling analog output AO2 eg. through fieldbus. In 113.22 AO2 source, select AO2 data storage. Then set this parameter as the target of the incoming value data.</p>	0.00
	-327.68 ... 327.67	Storage parameter for AO2.	100 = 1

No.	Name/Value	Description	Def/FbEq16
	114 Extension I/O module 1	Configuration of I/O extension module 1. See also section <i>Programmable I/O extensions</i> (page 22). Note: The contents of the parameter group vary according to the selected I/O extension module type.	
114.01	Module 1 type	Activates (and specifies the type of) I/O extension module 1.	<i>None</i>
	None	Inactive.	0
	FIO-01	FIO-01.	1
	FIO-11	FIO-11.	2
	FDIO-01	FDIO-01.	3
	FAIO-01	FAIO-01.	4
114.02	Module 1 location	Specifies the node number (1...3) on the control unit into which the I/O extension module is installed. (Node 1 = slot 1, node 2 = slot 2, node 3 = slot 3) Alternatively, specifies the node ID of the slot on an FEA-0x extension adapter.	<i>Slot 1</i>
	Slot 1	Slot 1.	1
	Slot 2	Slot 2.	2
	Slot 3	Slot 3.	3
	4...254	Node ID of the slot on the FEA-03 extension adapter.	1 = 1
114.03	Module 1 status	Displays the status of I/O extension module 1.	<i>No option</i>
	No option	No module detected in the specified slot.	0
	No communication	A module has been detected but cannot be communicated with.	1
	Unknown	The module type is unknown.	2
	FIO-01	An FIO-01 module has been detected and is active.	3
	FIO-11	An FIO-11 module has been detected and is active.	4
	FAIO-01	An FAIO-01 module has been detected and is active.	24
	FDIO-01	An FDIO-01 module has been detected and is active.	25
114.05	DI status	<i>(Visible when 114.01 Module 1 type = FDIO-01)</i> Displays the status of the digital inputs on the extension module. The activation/deactivation delays (if any are specified) are ignored. A filtering time (for input mode) can be defined by parameter <i>114.08 DI filter time</i> . Bit 0 indicates the status of DI1. Note: The number of active bits in this parameter depends on the number of digital input/outputs on the extension module. Example: 0101b = DI1 and DI3 are on, remainder are off. This parameter is read-only.	-
	0000b...1111b	Status of digital inputs.	1 = 1
114.05	DIO status	<i>(Visible when 114.01 Module 1 type = FIO-01 or FIO-11)</i> Displays the electrical status of the digital input/outputs on the extension module. The activation/deactivation delays (if any are specified) are ignored. Bit 0 indicates the status of DIO1. Note: The number of active bits in this parameter depends on the number of digital input/outputs on the extension module. Example: 1001b = DIO1 and DIO4 are on, remainder are off. This parameter is read-only.	-
	0000b...1111b	Status of digital input/outputs.	1 = 1

No.	Name/Value	Description	Def/FbEq16
114.06	<i>DI delayed status</i>	(Visible when 114.01 Module 1 type = FDIO-01) Displays the delayed status of the digital inputs on the extension module. The word is updated only after activation/deactivation delays (if any are specified). Bit 0 indicates the status of DI1. Note: The number of active bits in this parameter depends on the number of digital inputs on the extension module. Example: 0101b = DI1 and DI3 are on, remainder are off. This parameter is read-only.	-
	0000b...1111b	Delayed status of digital inputs.	1 = 1
114.06	<i>DIO delayed status</i>	(Visible when 114.01 Module 1 type = FIO-01 or FIO-11) Displays the status of the digital input/outputs on the extension module. This word is updated only after activation/deactivation delays (if any are specified). Bit 0 indicates the status of DIO1. Note: The number of active bits in this parameter depends on the number of digital input/outputs on the extension module. Example: 1001b = DIO1 and DIO4 are on, remainder are off. This parameter is read-only.	-
	0000b...1111b	Delayed status of digital input/outputs.	1 = 1
114.08	<i>DI filter time</i>	(Visible when 114.01 Module 1 type = FDIO-01) Defines a filtering time for parameter 114.05 DI status.	10.0 ms
	0.8 ... 100.0 ms	Filtering time for 114.05.	10 = 1 ms
114.08	<i>DIO filter time</i>	(Visible when 114.01 Module 1 type = FIO-01 or FIO-11) Defines a filtering time for parameter 114.05 DIO status. The filtering time will only affect the DIOs that are in input mode.	10.0 ms
	0.8 ... 100.0 ms	Filtering time for 114.05.	10 = 1 ms
114.09	<i>DIO1 configuration</i>	(Visible when 114.01 Module 1 type = FIO-01 or FIO-11) Selects whether DIO1 of the extension module is used as a digital input or output.	Input
	Input	DIO1 is used as a digital input.	0
	Output	DIO1 is used as a digital output.	1
114.11	<i>DIO1 output source</i>	(Visible when 114.01 Module 1 type = FIO-01 or FIO-11) Selects a signal to be connected to digital input/output DIO1 when parameter 114.09 DIO1 configuration is set to Output.	Not energized
	Not energized	Output is not energized.	0
	Energized	Output is energized.	1
	Ready	Bit 0 of 106.11 Main status word (see page 48). Output is energized when the supply unit is ready.	2
	Charge ready	Bit 1 of 106.11 Main status word (see page 48). Output is energized when the intermediate circuit DC charging is ready.	3
	Enabled	Bit 0 of 106.16 Drive status word 1 (see page 48). Output is energized when the supply unit is enabled.	4
	Started	Bit 5 of 106.16 Drive status word 1 (see page 48). Output is energized when the supply unit is started.	5
	Running	Bit 4 of 106.16 Drive status word 1 (see page 48). Output is energized when the supply unit is running.	6
	Warning	Bit 7 of 106.11 Main status word (see page 48). Output is energized when a warning is active.	13
	Fault	Bit 3 of 106.11 Main status word (see page 48). Output is energized when a fault is active.	14
	MCB	Bit 13 of 106.16 Drive status word 1 (see page 48). Output is energized when MCB closing command is given.	15

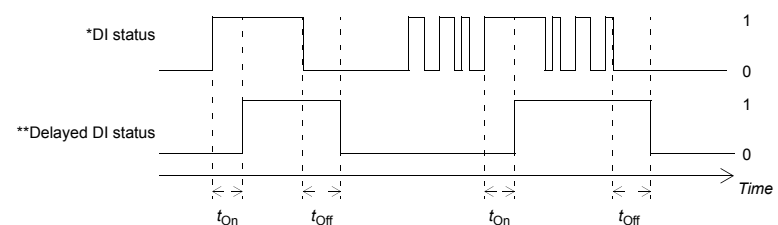
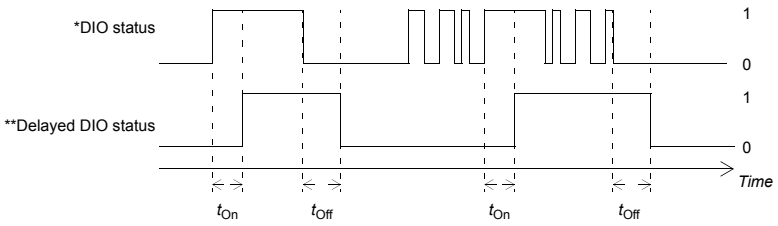
No.	Name/Value	Description	Def/FbEq16
	Charging	Bit 12 of <i>106.16 Drive status word 1</i> (see page 48). Output is energized when the external charging has charged the supply unit.	16
	<i>Other</i>	A specific bit in another parameter.	-
114.12	<i>DI1 ON delay</i>	(Visible when <i>114.01 Module 1 type = FDIO-01</i>) Defines the activation delay for digital input DI1.	0.00 s
 <p>t_{On} = <i>114.12 DI1 ON delay</i> t_{Off} = <i>114.13 DI1 OFF delay</i> *Electrical status of DI or status of selected source (in output mode). Indicated by <i>114.05 DI status</i>. **Indicated by <i>114.06 DI delayed status</i>.</p>			
	0.00 ... 3000.00 s	Activation delay for DI1.	10 = 1 s
114.12	<i>DIO1 ON delay</i>	(Visible when <i>114.01 Module 1 type = FIO-01</i> or <i>FIO-11</i>) Defines the activation delay for digital input/output DIO1.	0.0 s
 <p>t_{On} = <i>114.12 DIO1 ON delay</i> t_{Off} = <i>114.13 DIO1 OFF delay</i> *Electrical status of DIO (in input mode) or status of selected source (in output mode). Indicated by <i>114.05 DIO status</i>. **Indicated by <i>114.06 DIO delayed status</i>.</p>			
	0.0 ... 3000.0 s	Activation delay for DIO1.	10 = 1 s
114.13	<i>DI1 OFF delay</i>	(Visible when <i>114.01 Module 1 type = FDIO-01</i>) Defines the deactivation delay for digital input DI1. See parameter <i>114.12 DI1 ON delay</i> .	0.00 s
	0.00 ... 3000.00 s	Deactivation delay for DI1.	10 = 1 s
114.13	<i>DIO1 OFF delay</i>	(Visible when <i>114.01 Module 1 type = FIO-01</i> or <i>FIO-11</i>) Defines the deactivation delay for digital input/output DIO1. See parameter <i>114.12 DIO1 ON delay</i> .	0.0 s
	0.0 ... 3000.0 s	Deactivation delay for DIO1.	10 = 1 s
114.14	<i>DIO2 configuration</i>	(Visible when <i>114.01 Module 1 type = FIO-01</i> or <i>FIO-11</i>) Selects whether DIO2 of the extension module is used as a digital input or output.	<i>Input</i>
	Input	DIO2 is used as a digital input.	0
	Output	DIO2 is used as a digital output.	1
114.16	<i>DIO2 output source</i>	(Visible when <i>114.01 Module 1 type = FIO-01</i> or <i>FIO-11</i>) Selects a signal to be connected to digital input/output DIO2 when parameter <i>114.14 DIO2 configuration</i> is set to <i>Output</i> . For the available selections, see parameter <i>114.11 DIO1 output source</i> .	<i>Not energized</i>

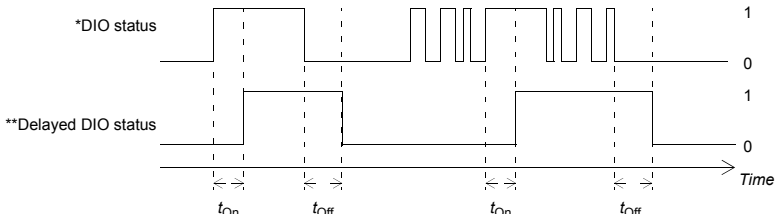
No.	Name/Value	Description	Def/FbEq16
114.17	<i>DI2 ON delay</i>	(Visible when 114.01 Module 1 type = FDIO-01) Defines the activation delay for digital input DI2. See parameter 114.12 DI1 ON delay.	0.00 s
	0.00 ... 3000.00 s	Activation delay for DI2.	10 = 1 s
114.17	<i>DIO2 ON delay</i>	(Visible when 114.01 Module 1 type = FIO-01 or FIO-11) Defines the activation delay for digital input/output DIO2.	0.0 s
	 <p>t_{On} = 114.17 DIO2 ON delay t_{Off} = 114.18 DIO2 OFF delay *Electrical status of DIO (in input mode) or status of selected source (in output mode). Indicated by 114.05 DIO status. **Indicated by 114.06 DIO delayed status.</p>		
	0.0 ... 3000.0 s	Activation delay for DIO2.	10 = 1 s
114.18	<i>DI2 OFF delay</i>	(Visible when 114.01 Module 1 type = FDIO-01) Defines the deactivation delay for digital input DI2. See parameter 114.12 DI1 ON delay.	0.00 s
	0.00 ... 3000.00 s	Deactivation delay for DI2.	10 = 1 s
114.18	<i>DIO2 OFF delay</i>	(Visible when 114.01 Module 1 type = FIO-01 or FIO-11) Defines the deactivation delay for digital input/output DIO2. See parameter 114.17 DIO2 ON delay.	0.0 s
	0.0 ... 3000.0 s	Deactivation delay for DIO2.	10 = 1 s
114.19	<i>DIO3 configuration</i>	(Visible when 114.01 Module 1 type = FIO-01) Selects whether DIO3 of the extension module is used as a digital input or output.	Input
	Input	DIO3 is used as a digital input.	0
	Output	DIO3 is used as a digital output.	1
114.19	<i>AI supervision function</i>	(Visible when 114.01 Module 1 type = FIO-11 or FAIO-01) Selects how the supply unit reacts when an analog input signal moves out of the minimum and/or maximum limits specified for the input. The inputs and the limits to be observed are selected by parameter 114.20 AI supervision selection.	No action
	No action	No action taken.	0
	Fault	Supply unit trips on 8E06 AI supervision.	1
	Warning	Supply unit generates an AE67 AI supervision warning.	2

70 Parameters

No.	Name/Value	Description	Def/FbEq16																								
114.20	<i>AI supervision selection</i>	(Visible when 114.01 Module 1 type = FIO-11 or FAIO-01) Specifies the analog input limits to be supervised. See parameter 114.19 <i>AI supervision function</i> .	0000h																								
<table border="1"> <thead> <tr> <th>Bit</th> <th>Name</th> <th>Description</th> </tr> </thead> <tbody> <tr> <td>0</td> <td>AI1 < MIN</td> <td>1 = Minimum limit supervision of AI1 active.</td> </tr> <tr> <td>1</td> <td>AI1 > MAX</td> <td>1 = Maximum limit supervision of AI1 active.</td> </tr> <tr> <td>2</td> <td>AI2 < MIN</td> <td>1 = Minimum limit supervision of AI2 active.</td> </tr> <tr> <td>3</td> <td>AI2 > MAX</td> <td>1 = Maximum limit supervision of AI2 active.</td> </tr> <tr> <td>4</td> <td>AI3 < MIN</td> <td>1 = Minimum limit supervision of AI3 active.</td> </tr> <tr> <td>5</td> <td>AI3 > MAX</td> <td>1 = Maximum limit supervision of AI3 active.</td> </tr> <tr> <td>6...15</td> <td>Reserved</td> <td></td> </tr> </tbody> </table>				Bit	Name	Description	0	AI1 < MIN	1 = Minimum limit supervision of AI1 active.	1	AI1 > MAX	1 = Maximum limit supervision of AI1 active.	2	AI2 < MIN	1 = Minimum limit supervision of AI2 active.	3	AI2 > MAX	1 = Maximum limit supervision of AI2 active.	4	AI3 < MIN	1 = Minimum limit supervision of AI3 active.	5	AI3 > MAX	1 = Maximum limit supervision of AI3 active.	6...15	Reserved	
Bit	Name	Description																									
0	AI1 < MIN	1 = Minimum limit supervision of AI1 active.																									
1	AI1 > MAX	1 = Maximum limit supervision of AI1 active.																									
2	AI2 < MIN	1 = Minimum limit supervision of AI2 active.																									
3	AI2 > MAX	1 = Maximum limit supervision of AI2 active.																									
4	AI3 < MIN	1 = Minimum limit supervision of AI3 active.																									
5	AI3 > MAX	1 = Maximum limit supervision of AI3 active.																									
6...15	Reserved																										
0000h...FFFFh		Activation of analog input supervision.	1 = 1																								
114.21	<i>DIO3 output source</i>	(Visible when 114.01 Module 1 type = FIO-01) Selects a signal to be connected to digital input/output DIO3 when parameter 114.19 <i>DIO3 configuration</i> is set to <i>Output</i> . For the available selections, see parameter 114.11 <i>DIO1 output source</i> .	<i>Not energized</i>																								
114.22	<i>DI3 ON delay</i>	(Visible when 114.01 Module 1 type = FDIO-01) Defines the activation delay for digital input DI3. See parameter 114.12 <i>DI1 ON delay</i> .	0.00 s																								
0.00 ... 3000.00 s		Activation delay for DI3.	10 = 1 s																								
114.22	<i>DIO3 ON delay</i>	(Visible when 114.01 Module 1 type = FIO-01) Defines the activation delay for digital input/output DIO3.	0.0 s																								
<p>$t_{On} = 114.22$ <i>DIO3 ON delay</i> $t_{Off} = 114.23$ <i>DIO3 OFF delay</i> *Electrical status of DIO (in input mode) or status of selected source (in output mode). Indicated by 114.05 <i>DIO status</i>. **Indicated by 114.06 <i>DIO delayed status</i>.</p>																											
0.0 ... 3000.0 s		Activation delay for DIO3.	10 = 1 s																								
114.22	<i>AI force sel</i>	(Visible when 114.01 Module 1 type = FIO-11 or FAIO-01) The true readings of the analog inputs can be overridden for eg. testing purposes. A forced value parameter is provided for each analog input, and its value is applied whenever the corresponding bit in this parameter is 1.	00000000h																								
<table border="1"> <thead> <tr> <th>Bit</th> <th>Value</th> </tr> </thead> <tbody> <tr> <td>0</td> <td>1 = Force AI1 to value of parameter 114.28 <i>AI1 force data</i>.</td> </tr> <tr> <td>1</td> <td>1 = Force AI2 to value of parameter 114.43 <i>AI2 force data</i>.</td> </tr> <tr> <td>2</td> <td>1 = Force AI3 to value of parameter 114.58 <i>AI3 force data</i>.</td> </tr> <tr> <td>3...31</td> <td>Reserved.</td> </tr> </tbody> </table>				Bit	Value	0	1 = Force AI1 to value of parameter 114.28 <i>AI1 force data</i> .	1	1 = Force AI2 to value of parameter 114.43 <i>AI2 force data</i> .	2	1 = Force AI3 to value of parameter 114.58 <i>AI3 force data</i> .	3...31	Reserved.														
Bit	Value																										
0	1 = Force AI1 to value of parameter 114.28 <i>AI1 force data</i> .																										
1	1 = Force AI2 to value of parameter 114.43 <i>AI2 force data</i> .																										
2	1 = Force AI3 to value of parameter 114.58 <i>AI3 force data</i> .																										
3...31	Reserved.																										
00000000h ... FFFFFFFFh		Forced values selector for analog inputs.	1 = 1																								

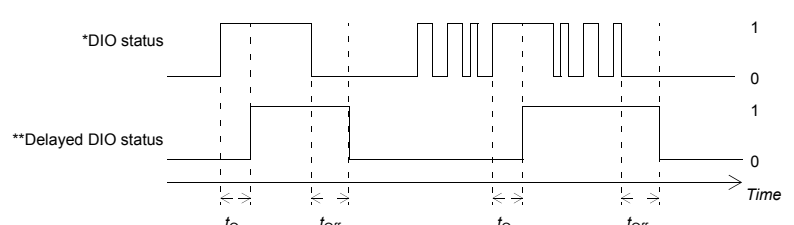
No.	Name/Value	Description	Def/FbEq16
114.23	<i>D13 OFF delay</i>	(Visible when 114.01 Module 1 type = FDIO-01) Defines the deactivation delay for digital input DI3. See parameter 114.12 DI1 ON delay.	0.00 s
	0.00 ... 3000.00 s	Deactivation delay for DI3.	10 = 1 s
114.23	<i>DIO3 OFF delay</i>	(Visible when 114.01 Module 1 type = FIO-01) Defines the deactivation delay for digital input/output DIO3. See parameter 114.22 DIO3 ON delay.	0.0 s
	0.0 ... 3000.0 s	Deactivation delay for DIO3.	10 = 1 s
114.24	<i>DIO4 configuration</i>	(Visible when 114.01 Module 1 type = FIO-01) Selects whether DIO4 of the I/O extension module is used as a digital input or output.	Input
	Input	DIO4 is used as a digital input.	0
	Output	DIO4 is used as a digital output.	1
114.26	<i>DIO4 output source</i>	(Visible when 114.01 Module 1 type = FIO-01) Selects a signal to be connected to digital input/output DIO4 when parameter 114.24 DIO4 configuration is set to Output. For the available selections, see parameter 114.11 DIO1 output source.	Not energized
114.26	<i>AI1 actual value</i>	(Visible when 114.01 Module 1 type = FIO-11 or FAIO-01) Displays the value of analog input AI1 in mA or V (depending on whether the input is set to current or voltage). This parameter is read-only.	-
	-22.000 ... 22.000 mA or V	Value of analog input AI1.	1000 = 1 mA or V
114.27	<i>DIO4 ON delay</i>	(Visible when 114.01 Module 1 type = FIO-01) Defines the activation delay for digital input/output DIO4.	0.0 s
	 <p>$t_{On} = 114.27$ DIO4 ON delay $t_{Off} = 114.28$ DIO4 OFF delay *Electrical status of DIO (in input mode) or status of selected source (in output mode). Indicated by 114.05 DIO status. **Indicated by 114.06 DIO delayed status.</p>		
	0.0 ... 3000.0 s	Activation delay for DIO4.	10 = 1 s
114.27	<i>AI1 scaled value</i>	(Visible when 114.01 Module 1 type = FIO-11 or FAIO-01) Displays the value of analog input AI1 after scaling. See parameter 114.35 AI1 scaled at AI1 min. This parameter is read-only.	-
	-32768.000 ... 32767.000	Scaled value of analog input AI1.	1 = 1
114.28	<i>DIO4 OFF delay</i>	(Visible when 114.01 Module 1 type = FIO-01) Defines the deactivation delay for digital input/output DIO4. See parameter 114.27 DIO4 ON delay.	0.0 s
	0.0 ... 3000.0 s	Deactivation delay for DIO4.	10 = 1 s
114.28	<i>AI1 force data</i>	(Visible when 114.01 Module 1 type = FIO-11 or FAIO-01) Forced value that can be used instead of the true reading of the input. See parameter 114.22 AI force sel.	-
	-22.000 ... 22.000 mA or V	Forced value of analog input AI1.	1000 = 1 mA or V

72 Parameters

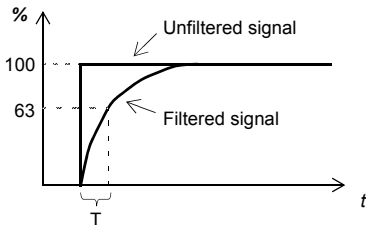
No.	Name/Value	Description	Def/FbEq16
114.29	AI1 HW switch pos	(Visible when 114.01 Module 1 type = FIO-11 or FAIO-01) Shows the position of the hardware current/voltage selector on the I/O extension module. Note: The setting of the current/voltage selector must match the unit selection made in parameter 114.30 AI1 unit selection.	-
	V	Volts.	2
	mA	Milliamperes.	10
114.30	AI1 unit selection	(Visible when 114.01 Module 1 type = FIO-11 or FAIO-01) Selects the unit for readings and settings related to analog input AI1. Note: This setting must match the corresponding hardware setting on the I/O extension module (see the manual of the I/O extension module). The hardware setting is shown by parameter 114.29 AI1 HW switch pos.	mA
	V	Volts.	2
	mA	Milliamperes.	10
114.31	RO status	(Visible when 114.01 Module 1 type = FIO-01 or FDIO-01) Status of relay outputs on the I/O extension module. Example: 00000001b = RO1 is energized, RO2 is de-energized.	-
	0000h...FFFFh	Status of relay outputs.	1 = 1
114.31	AI1 filter gain	(Visible when 114.01 Module 1 type = FIO-11 or FAIO-01) Selects a hardware filtering time for AI1. See also parameter 114.32 AI1 filter time.	No filtering
	No filtering	No filtering.	0
	125 us	125 microseconds.	1
	250 us	250 microseconds.	2
	500 us	500 microseconds.	3
	1 ms	1 millisecond.	4
	2 ms	2 milliseconds.	5
	4 ms	4 milliseconds.	6
	7.9375 ms	7.9375 milliseconds.	7
114.32	AI1 filter time	(Visible when 114.01 Module 1 type = FIO-11 or FAIO-01) Defines the filter time constant for analog input AI1.  $O = I \times (1 - e^{-t/T})$ <p>I = filter input (step) O = filter output t = time T = filter time constant</p> Note: The signal is also filtered due to the signal interface hardware. See parameter 114.31 AI1 filter gain.	0.040 s
	0.000 ... 30.000 s	Filter time constant.	1000 = 1 s

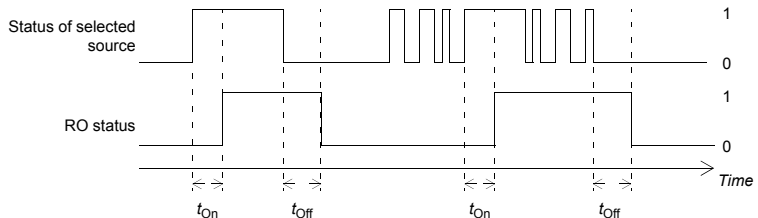
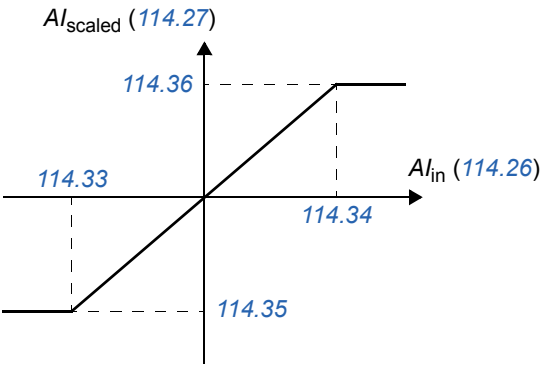
No.	Name/Value	Description	Def/FbEq16
114.33	<i>AI1 min</i>	(Visible when 114.01 Module 1 type = FIO-11 or FAIO-01) Defines the minimum value for analog input AI1.	0.000 mA or V
	-22.000 ... 22.000 mA or V	Minimum value of AI1.	1000 = 1 mA or V
114.34	<i>RO1 source</i>	(Visible when 114.01 Module 1 type = FIO-01 or FDIO-01) Selects a signal to be connected to relay output RO1. For the available selections, see parameter 114.11 DIO1 output source.	Not energized
114.34	<i>AI1 max</i>	(Visible when 114.01 Module 1 type = FIO-11 or FAIO-01) Defines the maximum value for analog input AI1.	10.000 mA or V
	-22.000 ... 22.000 mA or V	Maximum value of AI1.	1000 = 1 mA or V
114.35	<i>RO1 ON delay</i>	(Visible when 114.01 Module 1 type = FIO-01 or FDIO-01) Defines the activation delay for relay output RO1.	0.0 s
		 <p>$t_{On} = 114.35$ RO1 ON delay $t_{Off} = 114.36$ RO1 OFF delay</p>	
	0.0 ... 3000.0 s	Activation delay for RO1.	10 = 1 s
114.35	<i>AI1 scaled at AI1 min</i>	(Visible when 114.01 Module 1 type = FIO-11 or FAIO-01) Defines the real value that corresponds to the minimum analog input AI1 value defined by parameter 114.33 AI1 min.	0.000
			
	-32768.000 ... 32767.000	Real value corresponding to minimum AI1 value.	1 = 1
114.36	<i>RO1 OFF delay</i>	(Visible when 114.01 Module 1 type = FIO-01 or FDIO-01) Defines the deactivation delay for relay output RO1. See parameter 114.35 RO1 ON delay.	0.0 s
	0.0 ... 3000.0 s	Deactivation delay for RO1.	10 = 1 s
114.36	<i>AI1 scaled at AI1 max</i>	(Visible when 114.01 Module 1 type = FIO-11 or FAIO-01) Defines the real value that corresponds to the maximum analog input AI1 value defined by parameter 114.34 AI1 max. See the drawing at parameter 114.35 AI1 scaled at AI1 min.	1500.0
	-32768.000 ... 32767.000	Real value corresponding to maximum AI1 value.	1 = 1

74 Parameters

No.	Name/Value	Description	Def/FbEq16
114.37	RO2 source	(Visible when 114.01 Module 1 type = FIO-01 or FDIO-01) Selects a signal to be connected to relay output RO2. For the available selections, see parameter 114.11 DIO1 output source.	Not energized
114.38	RO2 ON delay	(Visible when 114.01 Module 1 type = FIO-01 or FDIO-01) Defines the activation delay for relay output RO2.	0.0 s
<p> t_{On} = 114.38 RO2 ON delay t_{Off} = 114.39 RO2 OFF delay </p>			
	0.0 ... 3000.0 s	Activation delay for RO2.	10 = 1 s
114.39	RO2 OFF delay	(Visible when 114.01 Module 1 type = FIO-01 or FDIO-01) Defines the deactivation delay for relay output RO1. See parameter 114.35 RO1 ON delay.	0.0 s
	0.0 ... 3000.0 s	Deactivation delay for RO2.	10 = 1 s
114.41	AI2 actual value	(Visible when 114.01 Module 1 type = FIO-11 or FAIO-01) Displays the value of analog input AI2 in mA or V (depending on whether the input is set to current or voltage). This parameter is read-only.	-
	-22.000 ... 22.000 mA or V	Value of analog input AI2.	1000 = 1 mA or V
114.42	AI2 scaled value	(Visible when 114.01 Module 1 type = FIO-11 or FAIO-01) Displays the value of analog input AI2 after scaling. See parameter 114.50 AI2 scaled at AI2 min. This parameter is read-only.	-
	-32768.000 ... 32767.000	Scaled value of analog input AI2.	1 = 1
114.43	AI2 force data	(Visible when 114.01 Module 1 type = FIO-11 or FAIO-01) Forced value that can be used instead of the true reading of the input. See parameter 114.22 AI force sel.	0.000 mA
	-22.000 ... 22.000 mA or V	Forced value of analog input AI2.	1000 = 1 mA or V
114.44	AI2 HW switch pos	(Visible when 114.01 Module 1 type = FIO-11 or FAIO-01) Shows the position of the hardware current/voltage selector on the I/O extension module. Note: The setting of the current/voltage selector must match the unit selection made in parameter 114.45 AI2 unit selection.	-
	V	Volts.	2
	mA	Milliamperes.	10
114.45	AI2 unit selection	(Visible when 114.01 Module 1 type = FIO-11 or FAIO-01) Selects the unit for readings and settings related to analog input AI2. Note: This setting must match the corresponding hardware setting on the I/O extension module (see the manual of the I/O extension module). The hardware setting is shown by parameter 114.44 AI2 HW switch pos.	mA
	V	Volts.	2
	mA	Milliamperes.	10

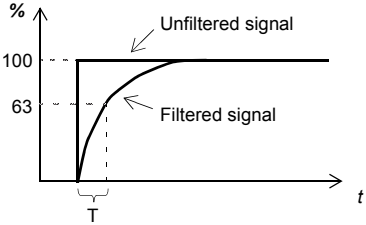
No.	Name/Value	Description	Def/FbEq16
114.46	<i>AI2 filter gain</i>	(Visible when 114.01 Module 1 type = FIO-11 or FAIO-01) Selects a hardware filtering time for AI2. See also parameter 114.47 <i>AI2 filter time</i> .	No filtering
	No filtering	No filtering.	0
	125 us	125 microseconds.	1
	250 us	250 microseconds.	2
	500 us	500 microseconds.	3
	1 ms	1 millisecond.	4
	2 ms	2 milliseconds.	5
	4 ms	4 milliseconds.	6
	7.9375 ms	7.9375 milliseconds.	7
114.47	<i>AI2 filter time</i>	(Visible when 114.01 Module 1 type = FIO-11 or FAIO-01) Defines the filter time constant for analog input AI2.  $O = I \times (1 - e^{-t/T})$ I = filter input (step) O = filter output t = time T = filter time constant Note: The signal is also filtered due to the signal interface hardware. See parameter 114.46 <i>AI2 filter gain</i> .	0.100 s
	0.000 ... 30.000 s	Filter time constant.	1000 = 1 s
114.48	<i>AI2 min</i>	(Visible when 114.01 Module 1 type = FIO-11 or FAIO-01) Defines the minimum value for analog input AI2.	0.000 mA or V
	-22.000 ... 22.000 mA or V	Minimum value of AI2.	1000 = 1 mA or V
114.49	<i>AI2 max</i>	(Visible when 114.01 Module 1 type = FIO-11 or FAIO-01) Defines the maximum value for analog input AI2.	10.000 mA or V
	-22.000 ... 22.000 mA or V	Maximum value of AI2.	1000 = 1 mA or V

76 Parameters

No.	Name/Value	Description	Def/FbEq16
114.50	<i>AI2 scaled at AI2 min</i>	<p>(Visible when 114.01 Module 1 type = FIO-11 or FAIO-01)</p> <p>Defines the real value that corresponds to the minimum analog input AI2 value defined by parameter 114.48 AI2 min.</p>	0.000
	-32768.000 ... 32767.000	Real value corresponding to minimum AI2 value.	1 = 1
114.51	<i>AI2 scaled at AI2 max</i>	<p>(Visible when 114.01 Module 1 type = FIO-11 or FAIO-01)</p> <p>Defines the real value that corresponds to the maximum analog input AI2 value defined by parameter 114.49 AI2 max. See the drawing at parameter 114.50 AI2 scaled at AI2 min.</p>	1500.0
	-32768.000 ... 32767.000	Real value corresponding to maximum AI2 value.	1 = 1
114.56	<i>AI3 actual value</i>	<p>(Visible when 114.01 Module 1 type = FIO-11)</p> <p>Displays the value of analog input AI3 in mA or V (depending on whether the input is set to current or voltage). This parameter is read-only.</p>	-
	-22.000 ... 22.000 mA or V	Value of analog input AI3.	1000 = 1 mA or V
114.57	<i>AI3 scaled value</i>	<p>(Visible when 114.01 Module 1 type = FIO-11)</p> <p>Displays the value of analog input AI3 after scaling. See parameter 114.65 AI3 scaled at AI3 min. This parameter is read-only.</p>	-
	-32768.000 ... 32767.000	Scaled value of analog input AI3.	1 = 1
114.58	<i>AI3 force data</i>	<p>(Visible when 114.01 Module 1 type = FIO-11)</p> <p>Forced value that can be used instead of the true reading of the input. See parameter 114.22 AI force sel.</p>	0.000 mA
	-22.000 ... 22.000 mA or V	Forced value of analog input AI3.	1000 = 1 mA or V
114.59	<i>AI3 HW switch pos</i>	<p>(Visible when 114.01 Module 1 type = FIO-11)</p> <p>Shows the position of the hardware current/voltage selector on the I/O extension module. Note: The setting of the current/voltage selector must match the unit selection made in parameter 114.60 AI3 unit selection.</p>	-
	V	Volts.	2
	mA	Milliamperes.	10

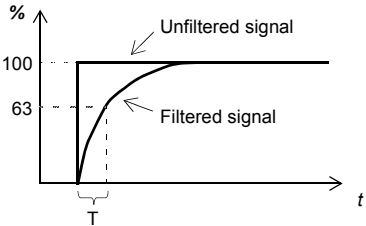
No.	Name/Value	Description	Def/FbEq16
114.60	<i>AI3 unit selection</i>	(Visible when 114.01 Module 1 type = FIO-11) Selects the unit for readings and settings related to analog input AI3. Note: This setting must match the corresponding hardware setting on the I/O extension module (see the manual of the I/O extension module). The hardware setting is shown by parameter 114.59 AI3 HW switch pos.	<i>mA</i>
	V	Volts.	2
	mA	Milliamperes.	10
114.61	<i>AI3 filter gain</i>	(Visible when 114.01 Module 1 type = FIO-11) Selects a hardware filtering time for AI3. See also parameter 114.62 AI3 filter time.	<i>No filtering</i>
	No filtering	No filtering.	0
	125 us	125 microseconds.	1
	250 us	250 microseconds.	2
	500 us	500 microseconds.	3
	1 ms	1 millisecond.	4
	2 ms	2 milliseconds.	5
	4 ms	4 milliseconds.	6
	7.9375 ms	7.9375 milliseconds.	7
114.62	<i>AI3 filter time</i>	(Visible when 114.01 Module 1 type = FIO-11) Defines the filter time constant for analog input AI3.  $O = I \times (1 - e^{-t/T})$ I = filter input (step) O = filter output t = time T = filter time constant Note: The signal is also filtered due to the signal interface hardware. See parameter 114.61 AI3 filter gain.	0.100 s
	0.000 ... 30.000 s	Filter time constant.	1000 = 1 s
114.63	<i>AI3 min</i>	(Visible when 114.01 Module 1 type = FIO-11) Defines the minimum value for analog input AI3.	0.000 mA or V
	-22.000 ... 22.000 mA or V	Minimum value of AI3.	1000 = 1 mA or V
114.64	<i>AI3 max</i>	(Visible when 114.01 Module 1 type = FIO-11) Defines the maximum value for analog input AI3.	10.000 mA or V
	-22.000 ... 22.000 mA or V	Maximum value of AI3.	1000 = 1 mA or V

78 Parameters

No.	Name/Value	Description	Def/FbEq16						
114.65	<i>AI3 scaled at AI3 min</i>	<p>(Visible when 114.01 Module 1 type = FIO-11)</p> <p>Defines the real value that corresponds to the minimum analog input AI3 value defined by parameter 114.63 AI3 min.</p>	0.000						
	-32768.000 ... 32767.000	Real value corresponding to minimum AI3 value.	1 = 1						
114.66	<i>AI3 scaled at AI3 max</i>	<p>(Visible when 114.01 Module 1 type = FIO-11)</p> <p>Defines the real value that corresponds to the maximum analog input AI3 value defined by parameter 114.64 AI3 max. See the drawing at parameter 114.65 AI3 scaled at AI3 min.</p>	1500.0						
	-32768.000 ... 32767.000	Real value corresponding to maximum AI3 value.	1 = 1						
114.71	<i>AO force selection</i>	<p>(Visible when 114.01 Module 1 type = FIO-11 or FAIO-01)</p> <p>The value of the analog output can be overridden for eg. testing purposes. A forced value parameter (114.78 AO1 force data) is provided for the analog output, and its value is applied whenever the corresponding bit in this parameter is 1.</p>	00000000h						
<table border="1"> <thead> <tr> <th>Bit</th> <th>Value</th> </tr> </thead> <tbody> <tr> <td>0</td> <td>1 = Force AO1 to value of parameter 114.78 AO1 force data.</td> </tr> <tr> <td>1...31</td> <td>Reserved.</td> </tr> </tbody> </table>				Bit	Value	0	1 = Force AO1 to value of parameter 114.78 AO1 force data.	1...31	Reserved.
Bit	Value								
0	1 = Force AO1 to value of parameter 114.78 AO1 force data.								
1...31	Reserved.								
	00000000h ... FFFFFFFFh	Forced values selector for analog outputs.	1 = 1						
114.76	<i>AO1 actual value</i>	<p>(Visible when 114.01 Module 1 type = FIO-11 or FAIO-01)</p> <p>Displays the value of AO1 in mA. This parameter is read-only.</p>	-						
	0.000 ... 22.000 mA	Value of AO1.	1000 = 1 mA						
114.77	<i>AO1 source</i>	<p>(Visible when 114.01 Module 1 type = FIO-11 or FAIO-01)</p> <p>Selects a signal to be connected to analog output AO1. Alternatively, sets the output to excitation mode to feed a constant current to a temperature sensor.</p>	<i>Zero</i>						
	Zero	None.	0						
	DC voltage	101.01 DC voltage	1						
	Line current	101.02 Line current	2						
	Other	The value is taken from another parameter.	-						
114.78	<i>AO1 force data</i>	<p>(Visible when 114.01 Module 1 type = FIO-11 or FAIO-01)</p> <p>Forced value that can be used instead of the selected output signal. See parameter 114.71 AO force selection.</p>	0.000 mA						
	0.000 ... 22.000 mA	Forced value of analog output AI1.	1000 = 1 mA						

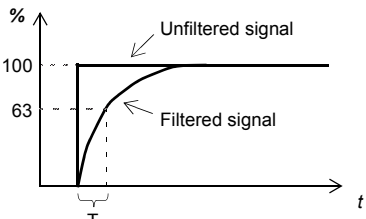
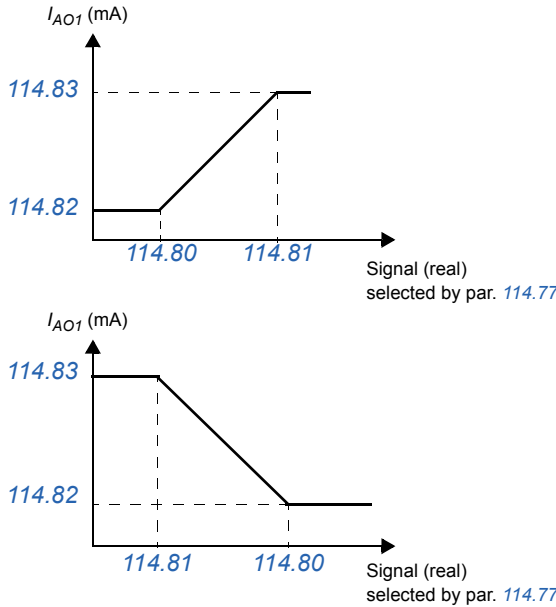
No.	Name/Value	Description	Def/FbEq16
114.79	AO1 filter time	<p>(Visible when 114.01 Module 1 type = FIO-11 or FAIO-01)</p> <p>Defines the filtering time constant for analog output AO1.</p>  <p>$O = I \times (1 - e^{-t/T})$</p> <p>I = filter input (step) O = filter output t = time T = filter time constant</p>	0.100 s
	0.000 ... 30.000 s	Filter time constant.	1000 = 1 s
114.80	AO1 source min	<p>(Visible when 114.01 Module 1 type = FIO-11 or FAIO-01)</p> <p>Defines the real value of the signal (selected by parameter 114.77 AO1 source) that corresponds to the minimum AO1 output value (defined by parameter 114.82 AO1 out at AO1 src min).</p>  <p>Signal (real) selected by par. 114.77</p> <p>Signal (real) selected by par. 114.77</p>	0.0
	-32768.0 ... 32767.0	Real signal value corresponding to minimum AO1 output value.	1 = 1
114.81	AO1 source max	<p>(Visible when 114.01 Module 1 type = FIO-11 or FAIO-01)</p> <p>Defines the real value of the signal (selected by parameter 114.77 AO1 source) that corresponds to the maximum AO1 output value (defined by parameter 114.83 AO1 out at AO1 src max). See parameter 114.80 AO1 source min.</p>	1500.0
	-32768.0 ... 32767.0	Real signal value corresponding to maximum AO1 output value.	1 = 1
114.82	AO1 out at AO1 src min	<p>(Visible when 114.01 Module 1 type = FIO-11 or FAIO-01)</p> <p>Defines the minimum output value for analog output AO1. See also drawing at parameter 114.80 AO1 source min.</p>	0.000 mA
	0.000 ... 22.000 mA	Minimum AO1 output value.	1000 = 1 mA

80 Parameters

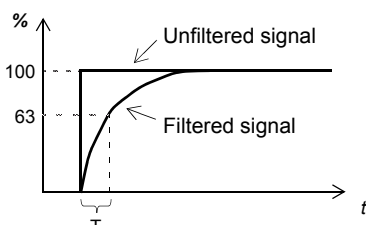
No.	Name/Value	Description	Def/FbEq16
114.83	<i>AO1 out at AO1 src max</i>	(Visible when 114.01 Module 1 type = FIO-11 or FAIO-01) Defines the maximum output value for analog output AO1. See also drawing at parameter 114.80 AO1 source min.	20.000 mA
	0.000 ... 22.000 mA	Maximum AO1 output value.	1000 = 1 mA
114.86	<i>AO2 actual value</i>	(Visible when 114.01 Module 1 type = FAIO-01) Displays the value of AO2 in mA. This parameter is read-only.	-
	0.000 ... 22.000 mA	Value of AO2.	1000 = 1 mA
114.87	<i>AO2 source</i>	(Visible when 114.01 Module 1 type = FAIO-01) Selects a signal to be connected to analog output AO2. Alternatively, sets the output to excitation mode to feed a constant current to a temperature sensor. For the selections, see parameter 114.77 AO1 source.	Zero
114.88	<i>AO2 force data</i>	(Visible when 114.01 Module 1 type = FAIO-01) Forced value that can be used instead of the selected output signal. See parameter 114.71 AO force selection.	0.000 mA
	0.000 ... 22.000 mA	Forced value of analog output AO2.	1000 = 1 mA
114.89	<i>AO2 filter time</i>	(Visible when 114.01 Module 1 type = FAIO-01) Defines the filtering time constant for analog output AO2.  $O = I \times (1 - e^{-t/T})$ I = filter input (step) O = filter output t = time T = filter time constant	0.100 s
	0.000 ... 30.000 s	Filter time constant.	1000 = 1 s

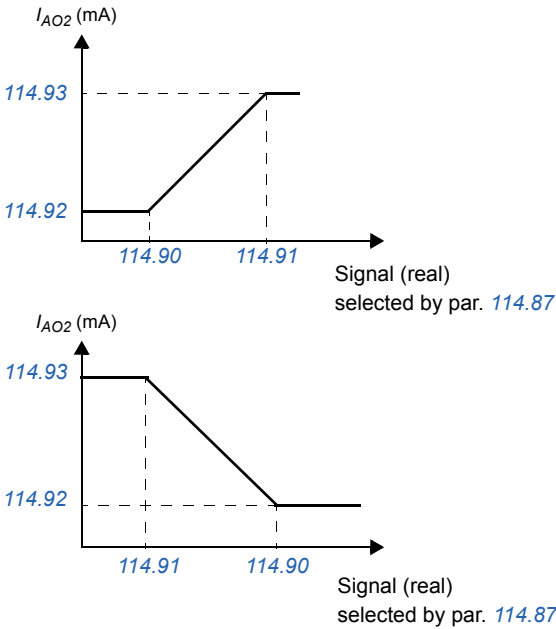
No.	Name/Value	Description	Def/FbEq16
114.90	<i>AO2 source min</i>	<p>(Visible when 114.01 Module 1 type = FAIO-01)</p> <p>Defines the real value of the signal (selected by parameter 114.87 AO2 source) that corresponds to the minimum AO2 output value (defined by parameter 114.92 AO2 out at AO2 src min).</p> 	0.0
	-32768.0 ... 32767.0	Real signal value corresponding to minimum AO2 output value.	1 = 1
114.91	<i>AO2 source max</i>	<p>(Visible when 114.01 Module 1 type = FAIO-01)</p> <p>Defines the real value of the signal (selected by parameter 114.87 AO2 source) that corresponds to the maximum AO2 output value (defined by parameter 114.93 AO2 out at AO2 src max). See parameter 114.90 AO2 source min.</p>	100.0
	-32768.0 ... 32767.0	Real signal value corresponding to maximum AO2 output value.	1 = 1
114.92	<i>AO2 out at AO2 src min</i>	<p>(Visible when 114.01 Module 1 type = FAIO-01)</p> <p>Defines the minimum output value for analog output AO2. See also drawing at parameter 114.90 AO2 source min.</p>	0.000 mA
	0.000 ... 22.000 mA	Minimum AO2 output value.	1000 = 1 mA
114.93	<i>AO2 out at AO2 src max</i>	<p>(Visible when 114.01 Module 1 type = FAIO-01)</p> <p>Defines the maximum output value for analog output AO2. See also drawing at parameter 114.90 AO2 source min.</p>	10.000 mA
	0.000 ... 22.000 mA	Maximum AO2 output value.	1000 = 1 mA
115 Extension I/O module 2		<p>Configuration of I/O extension module 2. See also section <i>Programmable I/O extensions</i> (page 22).</p> <p>Note: The contents of the parameter group vary according to the selected I/O extension module type.</p>	
115.01	<i>Module 2 type</i>	See parameter 114.01 Module 1 type.	None
115.02	<i>Module 2 location</i>	See parameter 114.02 Module 1 location.	Slot 1
115.03	<i>Module 2 status</i>	See parameter 114.03 Module 1 status.	No option
115.05	<i>DI status</i>	<p>(Visible when 115.01 Module 2 type = FDIO-01)</p> <p>See parameter 114.05 DI status.</p>	-

82 Parameters

No.	Name/Value	Description	Def/FbEq16
115.05	<i>DIO status</i>	(Visible when 115.01 Module 2 type = FIO-01 or FIO-11) See parameter 114.05 DIO status.	-
115.06	<i>DI delayed status</i>	(Visible when 115.01 Module 2 type = FDIO-01) See parameter 114.06 DI delayed status.	-
115.06	<i>DIO delayed status</i>	(Visible when 115.01 Module 2 type = FIO-01 or FIO-11) See parameter 114.06 DIO delayed status.	-
115.08	<i>DI filter time</i>	(Visible when 115.01 Module 2 type = FDIO-01) See parameter 114.08 DI filter time.	10.0 ms
115.08	<i>DIO filter time</i>	(Visible when 115.01 Module 2 type = FIO-01 or FIO-11) See parameter 114.08 DIO filter time.	10.0 ms
115.09	<i>DIO1 configuration</i>	(Visible when 115.01 Module 2 type = FIO-01 or FIO-11) See parameter 114.09 DIO1 configuration.	Input
115.11	<i>DIO1 output source</i>	(Visible when 115.01 Module 2 type = FIO-01 or FIO-11) See parameter 114.11 DIO1 output source.	Not energized
115.12	<i>DI1 ON delay</i>	(Visible when 115.01 Module 2 type = FDIO-01) See parameter 114.12 DI1 ON delay.	0.00 s
115.12	<i>DIO1 ON delay</i>	(Visible when 115.01 Module 2 type = FIO-01 or FIO-11) See parameter 114.12 DIO1 ON delay.	0.0 s
115.13	<i>DI1 OFF delay</i>	(Visible when 115.01 Module 2 type = FDIO-01) See parameter 114.13 DI1 OFF delay.	0.00 s
115.13	<i>DIO1 OFF delay</i>	(Visible when 115.01 Module 2 type = FIO-01 or FIO-11) See parameter 114.13 DIO1 OFF delay.	0.0 s
115.14	<i>DIO2 configuration</i>	(Visible when 115.01 Module 2 type = FIO-01 or FIO-11) See parameter 114.14 DIO2 configuration.	Input
115.16	<i>DIO2 output source</i>	(Visible when 115.01 Module 2 type = FIO-01 or FIO-11) See parameter 114.16 DIO2 output source.	Not energized
115.17	<i>DI2 ON delay</i>	(Visible when 115.01 Module 2 type = FDIO-01) See parameter 114.17 DI2 ON delay.	0.00 s
115.17	<i>DIO2 ON delay</i>	(Visible when 115.01 Module 2 type = FIO-01 or FIO-11) See parameter 114.17 DIO2 ON delay.	0.0 s
115.18	<i>DI2 OFF delay</i>	(Visible when 115.01 Module 2 type = FDIO-01) See parameter 114.18 DI2 OFF delay.	0.00 s
115.18	<i>DIO2 OFF delay</i>	(Visible when 115.01 Module 2 type = FIO-01 or FIO-11) See parameter 114.18 DIO2 OFF delay.	0.0 s
115.19	<i>DIO3 configuration</i>	(Visible when 115.01 Module 2 type = FIO-01) See parameter 114.19 DIO3 configuration.	Input
115.19	<i>AI supervision function</i>	(Visible when 115.01 Module 2 type = FIO-11 or FAIO-01) See parameter 114.19 AI supervision function.	No action
115.20	<i>AI supervision selection</i>	(Visible when 115.01 Module 2 type = FIO-11 or FAIO-01) See parameter 114.20 AI supervision selection.	0000h
115.21	<i>DIO3 output source</i>	(Visible when 115.01 Module 2 type = FIO-01) See parameter 114.21 DIO3 output source.	Not energized
115.22	<i>DI3 ON delay</i>	(Visible when 115.01 Module 2 type = FDIO-01) See parameter 114.22 DI3 ON delay.	0.00 s
115.22	<i>DIO3 ON delay</i>	(Visible when 115.01 Module 2 type = FIO-01) See parameter 114.22 DIO3 ON delay.	0.0 s
115.22	<i>AI force sel</i>	(Visible when 115.01 Module 2 type = FIO-11 or FAIO-01) See parameter 114.22 AI force sel.	00000000h
115.23	<i>DI3 OFF delay</i>	(Visible when 115.01 Module 2 type = FDIO-01) See parameter 114.23 DI3 OFF delay.	0.00 s
115.23	<i>DIO3 OFF delay</i>	(Visible when 115.01 Module 2 type = FIO-01) See parameter 114.23 DIO3 OFF delay.	0.0 s

No.	Name/Value	Description	Def/FbEq16
115.24	DIO4 configuration	(Visible when 115.01 Module 2 type = FIO-01) See parameter 114.24 DIO4 configuration.	Input
115.26	DIO4 output source	(Visible when 115.01 Module 2 type = FIO-01) See parameter 114.26 DIO4 output source.	Not energized
115.26	AI1 actual value	(Visible when 115.01 Module 2 type = FIO-11 or FAIO-01) See parameter 114.26 AI1 actual value.	-
115.27	DIO4 ON delay	(Visible when 115.01 Module 2 type = FIO-01) See parameter 114.27 DIO4 ON delay.	0.0 s
115.27	AI1 scaled value	(Visible when 115.01 Module 2 type = FIO-11 or FAIO-01) See parameter 114.27 AI1 scaled value.	-
115.28	DIO4 OFF delay	(Visible when 115.01 Module 2 type = FIO-01) See parameter 114.28 DIO4 OFF delay.	0.0 s
115.28	AI1 force data	(Visible when 115.01 Module 2 type = FIO-11 or FAIO-01) See parameter 114.28 AI1 force data.	-
115.29	AI1 HW switch pos	(Visible when 115.01 Module 2 type = FIO-11 or FAIO-01) See parameter 114.29 AI1 HW switch pos.	-
115.30	AI1 unit selection	(Visible when 115.01 Module 2 type = FIO-11 or FAIO-01) See parameter 114.30 AI1 unit selection.	mA
115.31	RO status	(Visible when 115.01 Module 2 type = FIO-01 or FDIO-01) See parameter 114.31 RO status.	-
115.31	AI1 filter gain	(Visible when 115.01 Module 2 type = FIO-11 or FAIO-01) See parameter 114.31 AI1 filter gain.	No filtering
115.32	AI1 filter time	(Visible when 115.01 Module 2 type = FIO-11 or FAIO-01) See parameter 114.32 AI1 filter time.	0.040 s
115.33	AI1 min	(Visible when 115.01 Module 2 type = FIO-11 or FAIO-01) See parameter 114.33 AI1 min.	0.000 mA or V
115.34	RO1 source	(Visible when 115.01 Module 2 type = FIO-01 or FDIO-01) See parameter 114.34 RO1 source.	Not energized
115.34	AI1 max	(Visible when 115.01 Module 2 type = FIO-11 or FAIO-01) See parameter 114.34 AI1 max.	10.000 mA or V
115.35	RO1 ON delay	(Visible when 115.01 Module 2 type = FIO-01 or FDIO-01) See parameter 114.35 RO1 ON delay.	0.0 s
115.35	AI1 scaled at AI1 min	(Visible when 115.01 Module 2 type = FIO-11 or FAIO-01) See parameter 114.35 AI1 scaled at AI1 min.	0.000
115.36	RO1 OFF delay	(Visible when 115.01 Module 2 type = FIO-01 or FDIO-01) See parameter 114.36 RO1 OFF delay.	0.0 s
115.36	AI1 scaled at AI1 max	(Visible when 115.01 Module 2 type = FIO-11 or FAIO-01) See parameter 114.36 AI1 scaled at AI1 max.	1500.0
115.37	RO2 source	(Visible when 115.01 Module 2 type = FIO-01 or FDIO-01) See parameter 114.37 RO2 source.	Not energized
115.38	RO2 ON delay	(Visible when 115.01 Module 2 type = FIO-01 or FDIO-01) See parameter 114.38 RO2 ON delay.	0.0 s
115.39	RO2 OFF delay	(Visible when 115.01 Module 2 type = FIO-01 or FDIO-01) See parameter 114.39 RO2 OFF delay.	0.0 s
115.41	AI2 actual value	(Visible when 115.01 Module 2 type = FIO-11 or FAIO-01) See parameter 114.41 AI2 actual value.	-
115.42	AI2 scaled value	(Visible when 115.01 Module 2 type = FIO-11 or FAIO-01) See parameter 114.42 AI2 scaled value.	-
115.43	AI2 force data	(Visible when 115.01 Module 2 type = FIO-11 or FAIO-01) See parameter 114.43 AI2 force data.	0.000 mA
115.44	AI2 HW switch pos	(Visible when 115.01 Module 2 type = FIO-11 or FAIO-01) See parameter 114.44 AI2 HW switch pos.	-

84 Parameters

No.	Name/Value	Description	Def/FbEq16
115.45	<i>AI2 unit selection</i>	(Visible when 115.01 Module 2 type = FIO-11 or FAIO-01) See parameter 114.45 AI2 unit selection.	<i>mA</i>
115.46	<i>AI2 filter gain</i>	(Visible when 115.01 Module 2 type = FIO-11 or FAIO-01) See parameter 114.46 AI2 filter gain.	<i>No filtering</i>
115.47	<i>AI2 filter time</i>	(Visible when 115.01 Module 2 type = FIO-11 or FAIO-01) See parameter 114.47 AI2 filter time.	0.100 s
115.48	<i>AI2 min</i>	(Visible when 115.01 Module 2 type = FIO-11 or FAIO-01) See parameter 114.48 AI2 min.	0.000 mA or V
115.49	<i>AI2 max</i>	(Visible when 115.01 Module 2 type = FIO-11 or FAIO-01) See parameter 114.49 AI2 max.	10.000 mA or V
115.50	<i>AI2 scaled at AI2 min</i>	(Visible when 115.01 Module 2 type = FIO-11 or FAIO-01) See parameter 114.50 AI2 scaled at AI2 min.	0.000
115.51	<i>AI2 scaled at AI2 max</i>	(Visible when 115.01 Module 2 type = FIO-11 or FAIO-01) See parameter 114.51 AI2 scaled at AI2 max.	1500.0
115.56	<i>AI3 actual value</i>	(Visible when 115.01 Module 2 type = FIO-11) See parameter 114.56 AI3 actual value.	-
115.57	<i>AI3 scaled value</i>	(Visible when 115.01 Module 2 type = FIO-11) See parameter 114.57 AI3 scaled value.	-
115.58	<i>AI3 force data</i>	(Visible when 115.01 Module 2 type = FIO-11) See parameter 114.58 AI3 force data.	0.000 mA
115.59	<i>AI3 HW switch pos</i>	(Visible when 115.01 Module 2 type = FIO-11) See parameter 114.59 AI3 HW switch pos.	-
115.60	<i>AI3 unit selection</i>	(Visible when 115.01 Module 2 type = FIO-11) See parameter 114.60 AI3 unit selection.	<i>mA</i>
115.61	<i>AI3 filter gain</i>	(Visible when 115.01 Module 2 type = FIO-11) See parameter 114.61 AI3 filter gain.	<i>No filtering</i>
115.62	<i>AI3 filter time</i>	(Visible when 115.01 Module 2 type = FIO-11) See parameter 114.62 AI3 filter time.	0.100 s
115.63	<i>AI3 min</i>	(Visible when 115.01 Module 2 type = FIO-11) See parameter 114.63 AI3 min.	0.000 mA or V
115.64	<i>AI3 max</i>	(Visible when 115.01 Module 2 type = FIO-11) See parameter 114.64 AI3 max.	10.000 mA or V
115.65	<i>AI3 scaled at AI3 min</i>	(Visible when 115.01 Module 2 type = FIO-11) See parameter 114.65 AI3 scaled at AI3 min.	0.000
115.66	<i>AI3 scaled at AI3 max</i>	(Visible when 115.01 Module 2 type = FIO-11) See parameter 114.66 AI3 scaled at AI3 max.	1500.0
115.71	<i>AO force selection</i>	(Visible when 115.01 Module 2 type = FIO-11 or FAIO-01) See parameter 114.71 AO force selection.	00000000h
115.76	<i>AO1 actual value</i>	(Visible when 115.01 Module 2 type = FIO-11 or FAIO-01) See parameter 114.76 AO1 actual value.	-
115.77	<i>AO1 source</i>	(Visible when 115.01 Module 2 type = FIO-11 or FAIO-01) See parameter 114.77 AO1 source.	<i>Zero</i>
115.78	<i>AO1 force data</i>	(Visible when 115.01 Module 2 type = FIO-11 or FAIO-01) See parameter 114.78 AO1 force data.	0.000 mA
115.79	<i>AO1 filter time</i>	(Visible when 115.01 Module 2 type = FIO-11 or FAIO-01) See parameter 114.79 AO1 filter time.	0.100 s
115.80	<i>AO1 source min</i>	(Visible when 115.01 Module 2 type = FIO-11 or FAIO-01) See parameter 114.80 AO1 source min.	0.0
115.81	<i>AO1 source max</i>	(Visible when 115.01 Module 2 type = FIO-11 or FAIO-01) See parameter 114.81 AO1 source max.	1500.0
115.82	<i>AO1 out at AO1 src min</i>	(Visible when 115.01 Module 2 type = FIO-11 or FAIO-01) See parameter 114.82 AO1 out at AO1 src min.	0.000 mA

No.	Name/Value	Description	Def/FbEq16
115.83	AO1 out at AO1 src max	(Visible when 115.01 Module 2 type = FIO-11 or FAIO-01) See parameter 114.83 AO1 out at AO1 src max.	20.000 mA
115.86	AO2 actual value	(Visible when 115.01 Module 2 type = FAIO-01) See parameter 114.86 AO2 actual value.	-
115.87	AO2 source	(Visible when 115.01 Module 2 type = FAIO-01) See parameter 114.87 AO2 source.	Zero
115.88	AO2 force data	(Visible when 115.01 Module 2 type = FAIO-01) See parameter 114.88 AO2 force data.	0.000 mA
115.89	AO2 filter time	(Visible when 115.01 Module 2 type = FAIO-01) See parameter 114.89 AO2 filter time.	0.100 s
115.90	AO2 source min	(Visible when 115.01 Module 2 type = FAIO-01) See parameter 114.90 AO2 source min.	0.0
115.91	AO2 source max	(Visible when 115.01 Module 2 type = FAIO-01) See parameter 114.91 AO2 source max.	100.0
115.92	AO2 out at AO2 src min	(Visible when 115.01 Module 2 type = FAIO-01) See parameter 114.92 AO2 out at AO2 src min.	0.000 mA
115.93	AO2 out at AO2 src max	(Visible when 115.01 Module 2 type = FAIO-01) See parameter 114.93 AO2 out at AO2 src max.	10.000 mA
116 Extension I/O module 3		Configuration of I/O extension module 3. See also section <i>Programmable I/O extensions</i> (page 22). Note: The contents of the parameter group vary according to the selected I/O extension module type.	
116.01	Module 3 type	See parameter 114.01 Module 1 type.	None
116.02	Module 3 location	See parameter 114.02 Module 1 location.	Slot 1
116.03	Module 3 status	See parameter 114.03 Module 1 status.	No option
116.05	DI status	(Visible when 116.01 Module 3 type = FDIO-01) See parameter 114.05 DI status.	-
116.05	DIO status	(Visible when 116.01 Module 3 type = FIO-01 or FIO-11) See parameter 114.05 DIO status.	-
116.06	DI delayed status	(Visible when 116.01 Module 3 type = FDIO-01) See parameter 114.06 DI delayed status.	-
116.06	DIO delayed status	(Visible when 116.01 Module 3 type = FIO-01 or FIO-11) See parameter 114.06 DIO delayed status.	-
116.08	DI filter time	(Visible when 116.01 Module 3 type = FDIO-01) See parameter 114.08 DI filter time.	10.0 ms
116.08	DIO filter time	(Visible when 116.01 Module 3 type = FIO-01 or FIO-11) See parameter 114.08 DIO filter time.	10.0 ms
116.09	DIO1 configuration	(Visible when 116.01 Module 3 type = FIO-01 or FIO-11) See parameter 114.09 DIO1 configuration.	Input
116.11	DIO1 output source	(Visible when 116.01 Module 3 type = FIO-01 or FIO-11) See parameter 114.11 DIO1 output source.	Not energized
116.12	DI1 ON delay	(Visible when 116.01 Module 3 type = FDIO-01) See parameter 114.12 DI1 ON delay.	0.00 s
116.12	DIO1 ON delay	(Visible when 116.01 Module 3 type = FIO-01 or FIO-11) See parameter 114.12 DIO1 ON delay.	0.0 s
116.13	DI1 OFF delay	(Visible when 116.01 Module 3 type = FDIO-01) See parameter 114.13 DI1 OFF delay.	0.00 s
116.13	DIO1 OFF delay	(Visible when 116.01 Module 3 type = FIO-01 or FIO-11) See parameter 114.13 DIO1 OFF delay.	0.0 s
116.14	DIO2 configuration	(Visible when 116.01 Module 3 type = FIO-01 or FIO-11) See parameter 114.14 DIO2 configuration.	Input

86 Parameters

No.	Name/Value	Description	Def/FbEq16
116.16	DIO2 output source	(Visible when 116.01 Module 3 type = FIO-01 or FIO-11) See parameter 114.16 DIO2 output source.	Not energized
116.17	DI2 ON delay	(Visible when 116.01 Module 3 type = FDIO-01) See parameter 114.17 DI2 ON delay.	0.00 s
116.17	DIO2 ON delay	(Visible when 116.01 Module 3 type = FIO-01 or FIO-11) See parameter 114.17 DIO2 ON delay.	0.0 s
116.18	DI2 OFF delay	(Visible when 116.01 Module 3 type = FDIO-01) See parameter 114.18 DI2 OFF delay.	0.00 s
116.18	DIO2 OFF delay	(Visible when 116.01 Module 3 type = FIO-01 or FIO-11) See parameter 114.18 DIO2 OFF delay.	0.0 s
116.19	DIO3 configuration	(Visible when 116.01 Module 3 type = FIO-01) See parameter 114.19 DIO3 configuration.	Input
116.19	AI supervision function	(Visible when 116.01 Module 3 type = FIO-11 or FAIO-01) See parameter 114.19 AI supervision function.	No action
116.20	AI supervision selection	(Visible when 116.01 Module 3 type = FIO-11 or FAIO-01) See parameter 114.20 AI supervision selection.	0000h
116.21	DIO3 output source	(Visible when 116.01 Module 3 type = FIO-01) See parameter 114.21 DIO3 output source.	Not energized
116.22	DI3 ON delay	(Visible when 116.01 Module 3 type = FDIO-01) See parameter 114.22 DI3 ON delay.	0.00 s
116.22	DIO3 ON delay	(Visible when 116.01 Module 3 type = FIO-01) See parameter 114.22 DIO3 ON delay.	0.0 s
116.22	AI force sel	(Visible when 116.01 Module 3 type = FIO-11 or FAIO-01) See parameter 114.22 AI force sel.	00000000h
116.23	DI3 OFF delay	(Visible when 116.01 Module 3 type = FDIO-01) See parameter 114.23 DI3 OFF delay.	0.00 s
116.23	DIO3 OFF delay	(Visible when 116.01 Module 3 type = FIO-01) See parameter 114.23 DIO3 OFF delay.	0.0 s
116.24	DIO4 configuration	(Visible when 116.01 Module 3 type = FIO-01) See parameter 114.24 DIO4 configuration.	Input
116.26	DIO4 output source	(Visible when 116.01 Module 3 type = FIO-01) See parameter 114.26 DIO4 output source.	Not energized
116.26	AI1 actual value	(Visible when 116.01 Module 3 type = FIO-11 or FAIO-01) See parameter 114.26 AI1 actual value.	-
116.27	DIO4 ON delay	(Visible when 116.01 Module 3 type = FIO-01) See parameter 114.27 DIO4 ON delay.	0.0 s
116.27	AI1 scaled value	(Visible when 116.01 Module 3 type = FIO-11 or FAIO-01) See parameter 114.27 AI1 scaled value.	-
116.28	DIO4 OFF delay	(Visible when 116.01 Module 3 type = FIO-01) See parameter 114.28 DIO4 OFF delay.	0.0 s
116.28	AI1 force data	(Visible when 116.01 Module 3 type = FIO-11 or FAIO-01) See parameter 114.28 AI1 force data.	-
116.29	AI1 HW switch pos	(Visible when 116.01 Module 3 type = FIO-11 or FAIO-01) See parameter 114.29 AI1 HW switch pos.	-
116.30	AI1 unit selection	(Visible when 116.01 Module 3 type = FIO-11 or FAIO-01) See parameter 114.30 AI1 unit selection.	mA
116.31	RO status	(Visible when 116.01 Module 3 type = FIO-01 or FDIO-01) See parameter 114.31 RO status.	-
116.31	AI1 filter gain	(Visible when 116.01 Module 3 type = FIO-11 or FAIO-01) See parameter 114.31 AI1 filter gain.	No filtering
116.32	AI1 filter time	(Visible when 116.01 Module 3 type = FIO-11 or FAIO-01) See parameter 114.32 AI1 filter time.	0.040 s

No.	Name/Value	Description	Def/FbEq16
116.33	AI1 min	(Visible when 116.01 Module 3 type = FIO-11 or FAIO-01) See parameter 114.33 AI1 min.	0.000 mA or V
116.34	RO1 source	(Visible when 116.01 Module 3 type = FIO-01 or FDIO-01) See parameter 114.34 RO1 source.	Not energized
116.34	AI1 max	(Visible when 116.01 Module 3 type = FIO-11 or FAIO-01) See parameter 114.34 AI1 max.	10.000 mA or V
116.35	RO1 ON delay	(Visible when 116.01 Module 3 type = FIO-01 or FDIO-01) See parameter 114.35 RO1 ON delay.	0.0 s
116.35	AI1 scaled at AI1 min	(Visible when 116.01 Module 3 type = FIO-11 or FAIO-01) See parameter 114.35 AI1 scaled at AI1 min.	0.000
116.36	RO1 OFF delay	(Visible when 116.01 Module 3 type = FIO-01 or FDIO-01) See parameter 114.36 RO1 OFF delay.	0.0 s
116.36	AI1 scaled at AI1 max	(Visible when 116.01 Module 3 type = FIO-11 or FAIO-01) See parameter 114.36 AI1 scaled at AI1 max.	1500.0
116.37	RO2 source	(Visible when 116.01 Module 3 type = FIO-01 or FDIO-01) See parameter 114.37 RO2 source.	Not energized
116.38	RO2 ON delay	(Visible when 116.01 Module 3 type = FIO-01 or FDIO-01) See parameter 114.38 RO2 ON delay.	0.0 s
116.39	RO2 OFF delay	(Visible when 116.01 Module 3 type = FIO-01 or FDIO-01) See parameter 114.39 RO2 OFF delay.	0.0 s
116.41	AI2 actual value	(Visible when 116.01 Module 3 type = FIO-11 or FAIO-01) See parameter 114.41 AI2 actual value.	-
116.42	AI2 scaled value	(Visible when 116.01 Module 3 type = FIO-11 or FAIO-01) See parameter 114.42 AI2 scaled value.	-
116.43	AI2 force data	(Visible when 116.01 Module 3 type = FIO-11 or FAIO-01) See parameter 114.43 AI2 force data.	0.000 mA
116.44	AI2 HW switch pos	(Visible when 116.01 Module 3 type = FIO-11 or FAIO-01) See parameter 114.44 AI2 HW switch pos.	-
116.45	AI2 unit selection	(Visible when 116.01 Module 3 type = FIO-11 or FAIO-01) See parameter 114.45 AI2 unit selection.	mA
116.46	AI2 filter gain	(Visible when 116.01 Module 3 type = FIO-11 or FAIO-01) See parameter 114.46 AI2 filter gain.	No filtering
116.47	AI2 filter time	(Visible when 116.01 Module 3 type = FIO-11 or FAIO-01) See parameter 114.47 AI2 filter time.	0.100 s
116.48	AI2 min	(Visible when 116.01 Module 3 type = FIO-11 or FAIO-01) See parameter 114.48 AI2 min.	0.000 mA or V
116.49	AI2 max	(Visible when 116.01 Module 3 type = FIO-11 or FAIO-01) See parameter 114.49 AI2 max.	10.000 mA or V
116.50	AI2 scaled at AI2 min	(Visible when 116.01 Module 3 type = FIO-11 or FAIO-01) See parameter 114.50 AI2 scaled at AI2 min.	0.000
116.51	AI2 scaled at AI2 max	(Visible when 116.01 Module 3 type = FIO-11 or FAIO-01) See parameter 114.51 AI2 scaled at AI2 max.	1500.0
116.56	AI3 actual value	(Visible when 116.01 Module 3 type = FIO-11) See parameter 114.56 AI3 actual value.	-
116.57	AI3 scaled value	(Visible when 116.01 Module 3 type = FIO-11) See parameter 114.57 AI3 scaled value.	-
116.58	AI3 force data	(Visible when 116.01 Module 3 type = FIO-11) See parameter 114.58 AI3 force data.	0.000 mA
116.59	AI3 HW switch pos	(Visible when 116.01 Module 3 type = FIO-11) See parameter 114.59 AI3 HW switch pos.	-
116.60	AI3 unit selection	(Visible when 116.01 Module 3 type = FIO-11) See parameter 114.60 AI3 unit selection.	mA

88 Parameters

No.	Name/Value	Description	Def/FbEq16
116.61	AI3 filter gain	(Visible when 116.01 Module 3 type = FIO-11) See parameter 114.61 AI3 filter gain.	No filtering
116.62	AI3 filter time	(Visible when 116.01 Module 3 type = FIO-11) See parameter 114.62 AI3 filter time.	0.100 s
116.63	AI3 min	(Visible when 116.01 Module 3 type = FIO-11) See parameter 114.63 AI3 min.	0.000 mA or V
116.64	AI3 max	(Visible when 116.01 Module 3 type = FIO-11) See parameter 114.64 AI3 max.	10.000 mA or V
116.65	AI3 scaled at AI3 min	(Visible when 116.01 Module 3 type = FIO-11) See parameter 114.65 AI3 scaled at AI3 min.	0.000
116.66	AI3 scaled at AI3 max	(Visible when 116.01 Module 3 type = FIO-11) See parameter 114.66 AI3 scaled at AI3 max.	1500.0
116.71	AO force selection	(Visible when 116.01 Module 3 type = FIO-11 or FAIO-01) See parameter 114.71 AO force selection.	00000000h
116.76	AO1 actual value	(Visible when 116.01 Module 3 type = FIO-11 or FAIO-01) See parameter 114.76 AO1 actual value.	-
116.77	AO1 source	(Visible when 116.01 Module 3 type = FIO-11 or FAIO-01) See parameter 114.77 AO1 source.	Zero
116.78	AO1 force data	(Visible when 116.01 Module 3 type = FIO-11 or FAIO-01) See parameter 114.78 AO1 force data.	0.000 mA
116.79	AO1 filter time	(Visible when 116.01 Module 3 type = FIO-11 or FAIO-01) See parameter 114.79 AO1 filter time.	0.100 s
116.80	AO1 source min	(Visible when 116.01 Module 3 type = FIO-11 or FAIO-01) See parameter 114.80 AO1 source min.	0.0
116.81	AO1 source max	(Visible when 116.01 Module 3 type = FIO-11 or FAIO-01) See parameter 114.81 AO1 source max.	1500.0
116.82	AO1 out at AO1 src min	(Visible when 116.01 Module 3 type = FIO-11 or FAIO-01) See parameter 114.82 AO1 out at AO1 src min.	0.000 mA
116.83	AO1 out at AO1 src max	(Visible when 116.01 Module 3 type = FIO-11 or FAIO-01) See parameter 114.83 AO1 out at AO1 src max.	20.000 mA
116.86	AO2 actual value	(Visible when 116.01 Module 3 type = FAIO-01) See parameter 114.86 AO2 actual value.	-
116.87	AO2 source	(Visible when 116.01 Module 3 type = FAIO-01) See parameter 114.87 AO2 source.	Zero
116.88	AO2 force data	(Visible when 116.01 Module 3 type = FAIO-01) See parameter 114.88 AO2 force data.	0.000 mA
116.89	AO2 filter time	(Visible when 116.01 Module 3 type = FAIO-01) See parameter 114.89 AO2 filter time.	0.100 s
116.90	AO2 source min	(Visible when 116.01 Module 3 type = FAIO-01) See parameter 114.90 AO2 source min.	0.0
116.91	AO2 source max	(Visible when 116.01 Module 3 type = FAIO-01) See parameter 114.91 AO2 source max.	100.0
116.92	AO2 out at AO2 src min	(Visible when 116.01 Module 3 type = FAIO-01) See parameter 114.92 AO2 out at AO2 src min.	0.000 mA
116.93	AO2 out at AO2 src max	(Visible when 116.01 Module 3 type = FAIO-01) See parameter 114.93 AO2 out at AO2 src max.	10.000 mA
119 Operation mode		Selection of external control location sources and operating modes.	
119.11	Ext1/Ext2 sel	Selects the external control location EXT1/EXT2.	EXT1
	EXT1	EXT1 selected.	0
	EXT2	EXT2 selected.	1

No.	Name/Value	Description	Def/FbEq16						
	FBA A MCW bit 11	106.01 Main control word , bit 11 received through fieldbus interface A.	2						
	DI1	Digital input DI1 (as indicated by 110.02 DI delayed status , bit 0). Note: DI1 is reserved for temperature fault in the control program. Do not select it for any other use.	3						
	DI2	Digital input DI2 (as indicated by 110.02 DI delayed status , bit 1).	4						
	DI3	Digital input DI3 (as indicated by 110.02 DI delayed status , bit 2). Note: DI3 is reserved for main breaker/contactors fault in the control program. Do not select it for any other use.	5						
	DI4	Digital input DI4 (as indicated by 110.02 DI delayed status , bit 3). Note: DI4 is reserved for auxiliary circuit breaker fault in the control program. Do not select it for any other use.	6						
	DI5	Digital input DI5 (as indicated by 110.02 DI delayed status , bit 4).	7						
	DI6	Digital input DI6 (as indicated by 110.02 DI delayed status bit 5).	8						
	DIO1	Digital input/output DIO1 (as indicated by 111.02 DIO delayed status , bit 0).	11						
	DIO2	Digital input/output DIO2 (as indicated by 111.02 DIO delayed status , bit 1).	12						
	<i>Other [bit]</i>	Source selection (see Terms and abbreviations on page 41).	-						
119.17	Local ctrl disable	Enables/disables (or selects a source that enables/disables) local control.  WARNING! Before disabling local control, ensure that the control panel is not needed for stopping the supply unit.	No						
	No	Local control enabled.	0						
	Yes	Local control disabled.	1						
120 Start/stop		Start/stop and run/start enable signal source selection; charging settings.							
120.01	Ext1 commands	Selects the source of start and stop commands for external control location 1 (EXT1). Note: This parameter cannot be changed while the converter is running.	In1 Start						
	Not sel	No start or stop command sources selected.	0						
	In1 Start	The source of the start and stop commands is selected by parameter 120.03 Ext1 in1 . The state transitions of the source bit are interpreted as follows: <table border="1" data-bbox="683 1686 1109 1816"> <thead> <tr> <th>State of source (120.03)</th> <th>Command</th> </tr> </thead> <tbody> <tr> <td>0 -> 1</td> <td>Start</td> </tr> <tr> <td>1 -> 0</td> <td>Stop</td> </tr> </tbody> </table>	State of source (120.03)	Command	0 -> 1	Start	1 -> 0	Stop	1
State of source (120.03)	Command								
0 -> 1	Start								
1 -> 0	Stop								

90 Parameters

No.	Name/Value	Description	Def/FbEq16												
	In1P Start; In2 Stop	The sources of the start and stop commands are selected by parameters 120.03 Ext1 in1 and 120.04 Ext1 in2 . The state transitions of the source bits are interpreted as follows: <table border="1" data-bbox="512 367 1115 533"> <thead> <tr> <th>State of source 1 (120.03)</th> <th>State of source 2 (120.04)</th> <th>Command</th> </tr> </thead> <tbody> <tr> <td>0 -> 1</td> <td>1</td> <td>Start</td> </tr> <tr> <td>Any</td> <td>1 -> 0</td> <td>Stop</td> </tr> <tr> <td>Any</td> <td>0</td> <td>Stop</td> </tr> </tbody> </table>	State of source 1 (120.03)	State of source 2 (120.04)	Command	0 -> 1	1	Start	Any	1 -> 0	Stop	Any	0	Stop	4
State of source 1 (120.03)	State of source 2 (120.04)	Command													
0 -> 1	1	Start													
Any	1 -> 0	Stop													
Any	0	Stop													
	Keypad	The start and stop commands are taken from the control panel (or PC connected to the control panel).	11												
	Fieldbus A	The start and stop commands are taken from fieldbus adapter A.	12												
	DDCS controller	The start and stop commands are taken from an external (DDCS) controller.	16												
120.02	Ext1 start trigger	Defines whether the start signal for external control location EXT1 is edge-triggered or level-triggered. Note: In case the settings of parameters 120.01 and 120.02 are in conflict, the setting of parameter 120.01 takes preference.	Edge												
	Edge	The start signal is edge-triggered.	0												
	Level	The start signal is level-triggered.	1												
120.03	Ext1 in1	Selects source 1 for external control location EXT1. See parameter 120.01 Ext1 commands .	DI2												
	Off	0.	0												
	On	1.	1												
	DI1	Digital input DI1 (as indicated by 110.02 DI delayed status , bit 0). Note: DI1 is reserved for temperature fault in the control program. Do not select it for any other use.	2												
	DI2	Digital input DI2 (as indicated by 110.02 DI delayed status , bit 1).	3												
	DI3	Digital input DI3 (as indicated by 110.02 DI delayed status , bit 2). Note: DI3 is reserved for main breaker/contactors fault in the control program. Do not select it for any other use.	4												
	DI4	Digital input DI4 (as indicated by 110.02 DI delayed status , bit 3). Note: DI4 is reserved for auxiliary circuit breaker fault in the control program. Do not select it for any other use.	5												
	DI5	Digital input DI5 (as indicated by 110.02 DI delayed status , bit 4).	6												
	DI6	Digital input DI6 (as indicated by 110.02 DI delayed status bit 5).	7												
	DIO1	Digital input/output DIO1 (as indicated by 111.02 DIO delayed status , bit 0).	10												
	DIO2	Digital input /output DIO2 (as indicated by 111.02 DIO delayed status , bit 1).	11												
	Other [bit]	Source selection (see Terms and abbreviations on page 41).	-												
120.04	Ext1 in2	Selects source 2 for external control location EXT1. See parameter 120.01 Ext1 commands . For the available selections, see parameter 120.03 Ext1 in1 .	DI2												

No.	Name/Value	Description	Def/FbEq16												
120.06	<i>Ext2 commands</i>	Selects the source of start and stop commands for external control location 2 (EXT2). Note: This parameter cannot be changed while the converter is running.	<i>Not sel</i>												
	Not sel	No start or stop command sources selected.	0												
	In1 Start	The source of the start and stop commands is selected by parameter <i>120.08 Ext2 in1</i> . The state transitions of the source bit are interpreted as follows: <table border="1" data-bbox="678 539 1115 674"> <thead> <tr> <th>State of source (120.08)</th> <th>Command</th> </tr> </thead> <tbody> <tr> <td>0 -> 1</td> <td>Start</td> </tr> <tr> <td>1 -> 0</td> <td>Stop</td> </tr> </tbody> </table>	State of source (120.08)	Command	0 -> 1	Start	1 -> 0	Stop	1						
State of source (120.08)	Command														
0 -> 1	Start														
1 -> 0	Stop														
	In1P Start; In2 Stop	The sources of the start and stop commands are selected by parameters <i>120.08 Ext2 in1</i> and <i>120.09 Ext2 in2</i> . The state transitions of the source bits are interpreted as follows: <table border="1" data-bbox="662 815 1264 981"> <thead> <tr> <th>State of source 1 (120.08)</th> <th>State of source 2 (120.09)</th> <th>Command</th> </tr> </thead> <tbody> <tr> <td>0 -> 1</td> <td>1</td> <td>Start</td> </tr> <tr> <td>Any</td> <td>1 -> 0</td> <td>Stop</td> </tr> <tr> <td>Any</td> <td>0</td> <td>Stop</td> </tr> </tbody> </table>	State of source 1 (120.08)	State of source 2 (120.09)	Command	0 -> 1	1	Start	Any	1 -> 0	Stop	Any	0	Stop	4
State of source 1 (120.08)	State of source 2 (120.09)	Command													
0 -> 1	1	Start													
Any	1 -> 0	Stop													
Any	0	Stop													
	Keypad	The start and stop commands are taken from the control panel (or PC connected to the control panel).	11												
	Fieldbus A	The start and stop commands are taken from fieldbus adapter A.	12												
	DDCS controller	The start and stop commands are taken from an external (DDCS) controller.	16												
120.07	<i>Ext2 start trigger</i>	Defines whether the start signal for external control location EXT2 is edge-triggered or level-triggered. Note: In case the settings of parameters <i>120.06</i> and <i>120.07</i> are in conflict, the setting of parameter <i>120.06</i> takes preference.	<i>Edge</i>												
	Edge	The start signal is edge-triggered.	0												
	Level	The start signal is level-triggered.	1												
120.08	<i>Ext2 in1</i>	Selects source 1 for external control location EXT2. See parameter <i>120.06 Ext2 commands</i> . For the available selections, see parameter <i>120.03 Ext1 in1</i> .	<i>Off</i>												
120.09	<i>Ext2 in2</i>	Selects source 2 for external control location EXT2. See parameter <i>120.06 Ext2 commands</i> . For the available selections, see parameter <i>120.03 Ext1 in1</i> .	<i>Off</i>												
120.12	<i>Run enable 1</i>	Selects the source of the external run enable signal. If the run enable signal is switched off, the supply unit will not start, or stops if running. 1 = Run enable. Note: This parameter cannot be changed while the converter is running.	<i>DI2</i>												
	Off	0.	0												
	On	1.	1												
	DI1	Digital input DI1 (as indicated by <i>110.02 DI delayed status</i> , bit 0). Note: DI1 is reserved for temperature fault in the control program. Do not select it for any other use.	2												

92 Parameters

No.	Name/Value	Description	Def/FbEq16
	DI2	Digital input DI2 (as indicated by 110.02 DI delayed status , bit 1).	3
	DI3	Digital input DI3 (as indicated by 110.02 DI delayed status , bit 2). Note: DI3 is reserved for main breaker/contactors fault in the control program. Do not select it for any other use.	4
	DI4	Digital input DI4 (as indicated by 110.02 DI delayed status , bit 3). Note: DI4 is reserved for auxiliary circuit breaker fault in the control program. Do not select it for any other use.	5
	DI5	Digital input DI5 (as indicated by 110.02 DI delayed status , bit 4).	6
	DI6	Digital input DI6 (as indicated by 110.02 DI delayed status bit 5).	7
	DIO1	Digital input/output DIO1 (as indicated by 111.02 DIO delayed status , bit 0).	10
	DIO2	Digital input/output DIO2 (as indicated by 111.02 DIO delayed status , bit 1).	11
	DIIL	DIIL input (110.02 DI delayed status , bit 15).	33
	Other [bit]	Source selection (see Terms and abbreviations on page 41).	-
120.19	Enable start signal	Selects the source for the start enable signal. 1 = Start enable. With the signal switched off, the converter will not start. (Switching the signal off while the converter is running will not stop it.)	On
	Off	0.	0
	On	1.	1
	DI1	Digital input DI1 (as indicated by 110.02 DI delayed status , bit 0). Note: DI1 is reserved for temperature fault in the control program. Do not select it for any other use.	2
	DI2	Digital input DI2 (as indicated by 110.02 DI delayed status , bit 1).	3
	DI3	Digital input DI3 (as indicated by 110.02 DI delayed status , bit 2). Note: DI3 is reserved for main breaker/contactors fault in the control program. Do not select it for any other use.	4
	DI4	Digital input DI4 (as indicated by 110.02 DI delayed status , bit 3). Note: DI4 is reserved for auxiliary circuit breaker fault in the control program. Do not select it for any other use.	5
	DI5	Digital input DI5 (as indicated by 110.02 DI delayed status , bit 4).	6
	DI6	Digital input DI6 (as indicated by 110.02 DI delayed status bit 5).	7
	DIO1	Digital input/output DIO1 (as indicated by 111.02 DIO delayed status , bit 0).	10
	DIO2	Digital input/output DIO2 (as indicated by 111.02 DIO delayed status , bit 1).	11
	DIIL	DIIL input (110.02 DI delayed status , bit 15).	30
	Other [bit]	Source selection (see Terms and abbreviations on page 41).	-

No.	Name/Value	Description	Def/FbEq16
120.21	<i>Delay for MCB DI3 supervision</i>	Start and stop delay for supervision of main circuit breaker DI3 feedback. After the delay a fault is given in start and stop states if the command and the feedback do not match.	1.00 s
	0.00 ... 8.00 s	Start and stop delay for supervision.	100 = 1 s
120.23	<i>Max DC charging time</i>	<u>DxD modules only</u> : Defines the maximum charging time for the charging function. See section Charging of DxD supply unit on page 35.	3.00 s
	0.00 ... 10.00 s	Maximum charging time	100 = 1 s
120.25	<i>MCB closing level</i>	<u>DxD modules only</u> : Defines the DC link voltage level for the charging function. When the measured DC link voltage exceeds the level, the main contactor/breaker can be closed.	80%
	20 ... 100%	Intermediate circuit DC voltage level in percent of the nominal	1 = 1%
120.26	<i>Maximum dU/dt</i>	<u>DxD modules only</u> : Defines the maximum DC link voltage change rate (dU/dt) for the charging function. When the change rate falls below this maximum change rate limit, the control program can close the main contactor/breaker. The change rate is measured in 10 ms sample interval. See section Charging of DxD supply unit on page 35.	50 V/s
	0 ... 200 V/s	Maximum dU/dt change	1 = 1 V/s
120.27	<i>Start delay</i>	<u>DxD modules only</u> : Defines the start delay that delay the setting of the charged state after the main circuit breaker has closed. Without charged state the start command is blocked from the modulator.	0.65 s
	0.00 ... 10.00 s	Start delay.	100 = 1 s
120.28	<i>MCB relay timing</i>	<u>DxD modules only</u> : Defines a contactor change-over delay time for the charging function. This is the delay between switching of the charging contactor and switching on the main contactor/breaker. The value can be positive or negative. The negative value defines the time when both contactors are closed. State 'charged' is set after charging contactor has opened and possible start delay parameter time has ended. See section Charging of DxD supply unit on page 35.	-0.10 s
	-6.00 ... 6.00 s	Delay between charging contactor opening and main circuit contactor closing.	100 = 1 s
120.30	<i>External charge enable</i>	<u>DxD modules only</u> : Enables the external charging function. See section Charging of DxD supply unit on page 35.	No
	No	External charging disabled.	0
	Yes	External charging enabled.	1
120.50	<i>Charging overload event sel</i>	<u>DxD modules only</u> : Selects the event type for external charging overload event. See section Charging of DxD supply unit on page 35.	Fault
	Fault	The supply unit trips on fault 3E09 Charging count .	0
	Warning	The supply unit generates a warning AE85 Charging count .	1
	No action	No action taken.	2
120.60	<i>DC voltage external unscaled</i>	<u>DxD modules only</u> : Defines the unscaled external DC voltage measurement received from the DDCS interface. For example when parameter 162.51 Data set 10 data 1 selection is set to External DC meas signal . Use this as the DC voltage measurement source by setting the parameter 195.40 DC voltage source to External measurement signal .	0.00
	0.00...65535.00	Unscaled external DC voltage measurement.	
120.61	<i>External DC voltage scale</i>	<u>DxD modules only</u> : Defines the scaling coefficient for the external DC voltage measurement.	0.10
	-100.00...100.00	Scaling coefficient for the external DC voltage measurement.	

94 Parameters

No.	Name/Value	Description	Def/FbEq16
121 Start/stop mode		Start and stop modes; emergency stop mode and signal source selection.	
121.04	Emergency stop mode	Selects the way the diode supply unit is stopped when an emergency stop command is received. The source of the emergency stop signal is selected with parameter 121.05 Emergency stop source .	<i>Stop and warning</i>
	Stop and warning	Stop the diode supply unit and show emergency stop warning.	0
	Warning	Show emergency stop warning but do not stop the diode supply unit.	1
	Fault	Stop the diode supply unit and create an emergency stop fault.	2
121.05	Emergency stop source	Selects the source of the emergency stop signal. 0 = Emergency stop active 1 = Normal operation Note: This parameter cannot be changed while the supply unit is running. If a cabinet-installed multidrive, ACS880-307, has an emergency stop option (+Q951/+Q952/+Q963/+Q964), this parameter has been set to DIIL at the factory.	<i>Inactive (true)</i>
	Active (false)	0.	0
	Inactive (true)	1.	1
	DIIL	DIIL input (<i>110.02 DI delayed status</i> , bit 15).	2
	DI1	Digital input DI1 (<i>110.02 DI delayed status</i> , bit 0).	3
	DI2	Digital input DI2 (<i>110.02 DI delayed status</i> , bit 1).	4
	DI3	Digital input DI3 (<i>110.02 DI delayed status</i> , bit 2).	5
	DI4	Digital input DI4 (<i>110.02 DI delayed status</i> , bit 3).	6
	DI5	Digital input DI5 (<i>110.02 DI delayed status</i> , bit 4).	7
	DI6	Digital input DI6 (<i>110.02 DI delayed status</i> , bit 5).	8
	DIO1	Digital input/output DIO1 (<i>111.02 DIO delayed status</i> , bit 0).	11
	DIO2	Digital input/output DIO2 (<i>111.02 DIO delayed status</i> , bit 1).	12
	<i>Other [bit]</i>	Source selection (see <i>Terms and abbreviations</i> on page 41).	-
131 Fault functions		Settings that define the behavior of the supply unit upon fault situations.	
131.01	External event 1 source	Defines the source of external event 1. See also parameter 131.02 External event 1 type .	<i>Inactive (true)</i>
	Active (false)	0	0
	Inactive (true)	1	1
	DIIL	Digital input DIIL (as indicated by <i>110.02 DI delayed status</i> , bit 15).	2
	DI1	Digital input DI1 (as indicated by <i>110.02 DI delayed status</i> , bit 0). Note: DI1 is reserved for temperature fault in the control program. Do not select it for any other use.	3
	DI2	Digital input DI2 (as indicated by <i>110.02 DI delayed status</i> , bit 1).	4
	DI3	Digital input DI3 (as indicated by <i>110.02 DI delayed status</i> , bit 2). Note: DI3 is reserved for main breaker/contactors fault in the control program. Do not select it for any other use.	5

No.	Name/Value	Description	Def/FbEq16
	DI4	Digital input DI4 (as indicated by 110.02 DI delayed status , bit 3). Note: DI4 is reserved for auxiliary circuit breaker fault in the control program. Do not select it for any other use.	6
	DI5	Digital input DI5 (as indicated by 110.02 DI delayed status , bit 4).	7
	DI6	Digital input DI6 (as indicated by 110.02 DI delayed status bit 5).	8
	DIO1	Digital input/output DIO1 (as indicated by 111.02 DIO delayed status , bit 0).	11
	DIO2	Digital input/output DIO2 (as indicated by 111.02 DIO delayed status , bit 1).	12
	<i>Other [bit]</i>	Source selection (see Terms and abbreviations on page 41).	-
131.02	External event 1 type	Selects the type of external event 1.	<i>Fault</i>
	Fault	The external event generates a fault.	0
	Warning	The external event generates a warning.	1
	Warning/Fault	If the diode supply unit is running, the external event generates a fault. Otherwise, the event generates a warning.	3
131.03	External event 2 source	Defines the source of external event 2. See also parameter 131.04 External event 2 type . For the selections, see parameter 131.01 External event 1 source .	<i>Inactive (true)</i>
131.04	External event 2 type	Selects the type of external event 2.	<i>Fault</i>
	Fault	The external event generates a fault.	0
	Warning	The external event generates a warning.	1
	Warning/Fault	If the diode supply unit is running, the external event generates a fault. Otherwise, the event generates a warning.	3
131.05	External event 3 source	Defines the source of external event 3. See also parameter 131.06 External event 3 type . For the selections, see parameter 131.01 External event 1 source .	<i>Inactive (true)</i>
131.06	External event 3 type	Selects the type of external event 3.	<i>Fault</i>
	Fault	The external event generates a fault.	0
	Warning	The external event generates a warning.	1
	Warning/Fault	If the diode supply unit is running, the external event generates a fault. Otherwise, the event generates a warning.	3
131.07	External event 4 source	Defines the source of external event 4. See also parameter 131.08 External event 4 type . For the selections, see parameter 131.01 External event 1 source .	<i>Inactive (true)</i>
131.08	External event 4 type	Selects the type of external event 4.	<i>Fault</i>
	Fault	The external event generates a fault.	0
	Warning	The external event generates a warning.	1
	Warning/Fault	If the diode supply unit is running, the external event generates a fault. Otherwise, the event generates a warning.	3
131.09	External event 5 source	Defines the source of external event 5. See also parameter 131.10 External event 5 type . For the selections, see parameter 131.01 External event 1 source .	<i>Inactive (true)</i>

No.	Name/Value	Description	Def/FbEq16
131.10	<i>External event 5 type</i>	Selects the type of external event 5.	<i>Fault</i>
	Fault	The external event generates a fault.	0
	Warning	The external event generates a warning.	1
	Warning/Fault	If the diode supply unit is running, the external event generates a fault. Otherwise, the event generates a warning.	3
131.11	<i>Fault reset selection</i>	Selects the source of an external fault reset signal. The signal resets the supply unit after a fault trip if the cause of the fault no longer exists. 0 -> 1 = Reset Note: A fault reset from the fieldbus interface is always observed regardless of this parameter.	<i>DI6</i>
	Off	0	0
	On	1	1
	DI1	Digital input DI1 (as indicated by <i>110.02 DI delayed status</i> , bit 0). Note: DI1 is reserved for temperature fault in the control program. Do not select it for any other use.	2
	DI2	Digital input DI2 (as indicated by <i>110.02 DI delayed status</i> , bit 1).	3
	DI3	Digital input DI3 (as indicated by <i>110.02 DI delayed status</i> , bit 2). Note: DI3 is reserved for main breaker/contactors fault in the control program. Do not select it for any other use.	4
	DI4	Digital input DI4 (as indicated by <i>110.02 DI delayed status</i> , bit 3). Note: DI4 is reserved for auxiliary circuit breaker fault in the control program. Do not select it for any other use.	5
	DI5	Digital input DI5 (as indicated by <i>110.02 DI delayed status</i> , bit 4).	6
	DI6	Digital input DI6 (as indicated by <i>110.02 DI delayed status</i> , bit 5).	7
	DIO1	Digital input/output DIO1 (as indicated by <i>111.02 DIO delayed status</i> , bit 0).	10
	DIO2	Digital input/output DIO2 (as indicated by <i>111.02 DIO delayed status</i> , bit 1).	11
	<i>Other [bit]</i>	Source selection (see <i>Terms and abbreviations</i> on page 41).	-

No.	Name/Value	Description	Def/FbEq16																						
131.12	<i>Autoreset selection</i>	<p>Selects faults that are automatically reset. The parameter is a 16-bit word with each bit corresponding to a fault type. Whenever a bit is set to 1, the corresponding fault is automatically reset.</p> <p>Note: The autoreset function is available in external control only.</p> <p> WARNING! The supply unit starts automatically after the autoreset if Start, Run enable and Start enable signals are on and the control program detects no fault. Before you activate the function, make sure that no dangerous situations can occur. The function resets the supply unit automatically and continues operation after a fault. If you select an external source for the start command and it is on, the supply unit will start immediately after fault reset.</p> <p>The bits of the binary number correspond to the following faults:</p>	0000h																						
<table border="1"> <thead> <tr> <th>Bit</th> <th>Fault</th> </tr> </thead> <tbody> <tr> <td>0</td> <td>Overcurrent (<i>2E00 Overcurrent</i>)</td> </tr> <tr> <td>1</td> <td>Overvoltage (<i>3E04 DC link overvoltage</i>)</td> </tr> <tr> <td>2</td> <td>Undervoltage (<i>3E05 DC link undervoltage</i>)</td> </tr> <tr> <td>3...9</td> <td>Reserved</td> </tr> <tr> <td>10</td> <td>User fault (selected by parameter <i>131.13 User selectable fault</i>)</td> </tr> <tr> <td>11</td> <td>External fault 1 (from source selected by parameter <i>131.01 External event 1 source</i>)</td> </tr> <tr> <td>12</td> <td>External fault 2 (from source selected by parameter <i>131.03 External event 2 source</i>)</td> </tr> <tr> <td>13</td> <td>External fault 3 (from source selected by parameter <i>131.05 External event 3 source</i>)</td> </tr> <tr> <td>14</td> <td>External fault 4 (from source selected by parameter <i>131.07 External event 4 source</i>)</td> </tr> <tr> <td>15</td> <td>External fault 5 (from source selected by parameter <i>131.09 External event 5 source</i>)</td> </tr> </tbody> </table>				Bit	Fault	0	Overcurrent (<i>2E00 Overcurrent</i>)	1	Overvoltage (<i>3E04 DC link overvoltage</i>)	2	Undervoltage (<i>3E05 DC link undervoltage</i>)	3...9	Reserved	10	User fault (selected by parameter <i>131.13 User selectable fault</i>)	11	External fault 1 (from source selected by parameter <i>131.01 External event 1 source</i>)	12	External fault 2 (from source selected by parameter <i>131.03 External event 2 source</i>)	13	External fault 3 (from source selected by parameter <i>131.05 External event 3 source</i>)	14	External fault 4 (from source selected by parameter <i>131.07 External event 4 source</i>)	15	External fault 5 (from source selected by parameter <i>131.09 External event 5 source</i>)
Bit	Fault																								
0	Overcurrent (<i>2E00 Overcurrent</i>)																								
1	Overvoltage (<i>3E04 DC link overvoltage</i>)																								
2	Undervoltage (<i>3E05 DC link undervoltage</i>)																								
3...9	Reserved																								
10	User fault (selected by parameter <i>131.13 User selectable fault</i>)																								
11	External fault 1 (from source selected by parameter <i>131.01 External event 1 source</i>)																								
12	External fault 2 (from source selected by parameter <i>131.03 External event 2 source</i>)																								
13	External fault 3 (from source selected by parameter <i>131.05 External event 3 source</i>)																								
14	External fault 4 (from source selected by parameter <i>131.07 External event 4 source</i>)																								
15	External fault 5 (from source selected by parameter <i>131.09 External event 5 source</i>)																								
	0000h...FFFFh	Automatic reset configuration word.	1 = 1																						
131.13	<i>User selectable fault</i>	<p>Defines the fault that can be automatically reset using parameter <i>131.12 Autoreset selection</i>, bit 10.</p> <p>The faults are listed in chapter <i>Fault tracing</i>.</p>	0000h																						
	0000h...FFFFh	Fault code. See chapter <i>Fault tracing</i> .	-																						
131.14	<i>Number of trials</i>	Defines the number of automatic fault resets the supply unit performs within the time defined by parameter <i>131.15 Total trials time</i> .	0																						
	0...5	Number of automatic resets.	-																						
131.15	<i>Total trials time</i>	Defines the time for the automatic reset function. See parameter <i>131.14 Number of trials</i> .	30																						
	1.0 ... 600.0 s	Time for automatic resets.	10 = 1 s																						
131.16	<i>Delay time</i>	Defines the time that the supply unit will wait after a fault before attempting an automatic reset. See parameter <i>131.12 Autoreset selection</i> .	0.0 s																						
	0.0 ... 120.0 s	Autoreset delay.	10 = 1 s																						
131.28	<i>Ext earth leakage signal source</i>	<p>Defines the source of earth leakage fault indication. Signal value is decoded as follows:</p> <p>0 = Earth leakage fault 1 = No earth leakage fault.</p>	<i>Inactive (true)</i>																						
	Active (false)	0. Earth leakage fault	0																						
	Inactive (true)	1. No earth leakage fault	1																						
	DIIL	Digital input DIIL (as indicated by <i>110.02 DI delayed status</i> , bit 15).	2																						

No.	Name/Value	Description	Def/FbEq16
	DI1	Digital input DI1 (as indicated by 110.02 DI delayed status , bit 0). Note: DI1 is reserved for temperature fault in the control program. Do not select it for any other use.	3
	DI2	Digital input DI2 (as indicated by 110.02 DI delayed status , bit 1).	4
	DI3	Digital input DI3 (as indicated by 110.02 DI delayed status , bit 2). Note: DI3 is reserved for main breaker/contactator fault in the control program. Do not select it for any other use.	5
	DI4	Digital input DI4 (as indicated by 110.02 DI delayed status , bit 3). Note: DI4 is reserved for auxiliary circuit breaker fault in the control program. Do not select it for any other use.	6
	DI5	Digital input DI5 (as indicated by 110.02 DI delayed status , bit 4).	7
	DI6	Digital input DI6 (as indicated by 110.02 DI delayed status bit 5).	8
	DIO1	Digital input/output DIO1 (as indicated by 111.02 DIO delayed status , bit 0).	11
	DIO2	Digital input/output DIO2 (as indicated by 111.02 DIO delayed status , bit 1).	12
	<i>Other [bit]</i>	Source selection (see Terms and abbreviations on page 41).	-
131.29	Ext earth leakage action	Selects how the diode supply unit reacts when an external earth leakage is detected.	<i>Fault</i>
	Warning	The diode supply unit generates a warning AE87 Ext earth leakage .	0
	Fault	The diode supply unit trips on a fault 2E08 Ext earth leakage .	1
131.32	Aux circuit breaker fault source	Defines the source for fault 5E13 Auxiliary circuit breaker fault . 0 = Fault 1 = No fault	<i>DI4</i>
	Active (false)	Auxiliary circuit breaker fault	0
	Inactive (true)	No auxiliary circuit breaker fault	1
	DIIL	Digital input DIIL (as indicated by 110.02 DI delayed status , bit 15).	2
	DI1	Digital input DI1 (as indicated by 110.02 DI delayed status , bit 0). Note: DI1 is reserved for temperature fault in the control program. Do not select it for any other use.	3
	DI2	Digital input DI2 (as indicated by 110.02 DI delayed status , bit 1).	4
	DI3	Digital input DI3 (as indicated by 110.02 DI delayed status , bit 2). Note: DI3 is reserved for main breaker/contactator fault in the control program. Do not select it for any other use.	5
	DI4	Digital input DI4 (as indicated by 110.02 DI delayed status , bit 3). Note: DI4 is reserved for auxiliary circuit breaker fault in the control program. Do not select it for any other use.	6
	DI5	Digital input DI5 (as indicated by 110.02 DI delayed status , bit 4).	7
	DI6	Digital input DI6 (as indicated by 110.02 DI delayed status bit 5).	8

No.	Name/Value	Description	Def/FbEq16
	DIO1	Digital input/output DIO1 (as indicated by 111.02 DIO delayed status , bit 0).	11
	DIO2	Digital input/output DIO2 (as indicated by 111.02 DIO delayed status , bit 1).	12
	<i>Other [bit]</i>	Source selection (see Terms and abbreviations on page 41).	-
131.33	<i>Cabinet temperature fault source</i>	Activates/inactivates the monitoring for the cabinet thermal switch, and defines the source for the monitored signal. If the monitoring detects an overtemperature, it trips the supply unit to fault 4E06 Cabinet temperature fault . Status of the monitored signal and implication: 1 = Temperature is normal -> no fault 0 = Overtemperature -> fault trip	<i>D11</i>
	Active (false)	Monitoring function is active.	0
	Inactive (true)	Monitoring function is inactive.	1
	DI1L	Monitoring function is active and it reads the status indication through DI1L (110.02 DI delayed status , bit 15).	2
	DI1	Monitoring function is active and it reads the status indication through DI1 (110.02 DI delayed status , bit 0).	3
	DI2	Monitoring function is active and it reads the status indication through DI2 (110.02 DI delayed status , bit 1).	4
	DI3	Monitoring function is active and it reads the status indication through DI3 (110.02 DI delayed status , bit 2).	5
	DI4	Monitoring function is active and it reads the status indication through DI4 (110.02 DI delayed status , bit 3).	6
	DI5	Monitoring function is active and it reads the status indication through DI5 (110.02 DI delayed status , bit 4).	7
	DI6	Monitoring function is active and it reads the status indication through DI6 (110.02 DI delayed status , bit 5).	8
	DIO1	Monitoring function is active and it reads the status indication through DIO1 (111.02 DIO delayed status , bit 0).	11
	DIO2	Monitoring function is active and it reads the status indication through DIO2 (111.02 DIO delayed status , bit 1).	12
	<i>Other [bit]</i>	Source selection (see Terms and abbreviations on page 41).	-
131.34	<i>Cabinet temperature supervision</i>	Selects whether there is a delay in monitoring the parameter 131.33 Cabinet temperature fault source . If this parameter is set to When modulating , the monitoring is started after the modulation has started. Otherwise there is no delay for the monitoring.	<i>When modulating</i>
	Always	There is no delay for the monitoring.	0
	When modulating	Cabinet temperature monitoring is started after the modulation has started.	1
131.35	<i>Main fan fault function</i>	Selects how the supply unit reacts when a main cooling fan fault is detected.	<i>Fault</i>
	Fault	The supply unit trips on fault 5E00 Fan .	0
	Warning	The supply unit generates an AE73 Fan warning.	1
	No action	No action taken.	2
131.38	<i>Fuse trip fault source</i>	Activates/inactivates the monitoring for the fuse trip, and defines the source for the monitored signal. If the monitoring detects a fuse trip, the supply unit trips to fault 5E1A Fuse trip . Status of the monitored signal and implication: 1 = No fault 0 = Fault.	<i>Inactive (true)</i>
	Active (false)	Monitoring function is active.	0

No.	Name/Value	Description	Def/FbEq16
	Inactive (true)	Monitoring function is inactive.	1
	DIIL	Monitoring function is active and it reads the status indication through DIIL (<i>110.02 DI delayed status</i> , bit 15).	2
	DI1	Monitoring function is active and it reads the status indication through DI1 (<i>110.02 DI delayed status</i> , bit 0).	3
	DI2	Monitoring function is active and it reads the status indication through DI2 (<i>110.02 DI delayed status</i> , bit 1).	4
	DI3	Monitoring function is active and it reads the status indication through DI3 (<i>110.02 DI delayed status</i> , bit 2).	5
	DI4	Monitoring function is active and it reads the status indication through DI4 (<i>110.02 DI delayed status</i> , bit 3).	6
	DI5	Monitoring function is active and it reads the status indication through DI5 (<i>110.02 DI delayed status</i> , bit 4).	7
	DI6	Monitoring function is active and it reads the status indication through DI6 (<i>110.02 DI delayed status</i> , bit 5).	8
	DIO1	Monitoring function is active and it reads the status indication through DIO1 (<i>111.02 DIO delayed status</i> , bit 0).	11
	DIO2	Monitoring function is active and it reads the status indication through DIO2 (<i>111.02 DIO delayed status</i> , bit 1).	12
	<i>Other</i>	Source selection (see <i>Terms and abbreviations</i> on page 41).	-
131.39	<i>Brake chopper fault source</i>	Activates/inactivates the monitoring for the brake chopper fault, and defines the source for the monitored signal. If the monitoring detects a brake chopper fault, the supply unit trips to fault <i>5E1B Brake chopper</i> . Monitoring is active only when the supply unit is running. Status of the monitored signal and implication: 1 = No fault 0 = Fault.	<i>Inactive (true)</i>
	Active (false)	Monitoring function is active.	0
	Inactive (true)	Monitoring function is inactive.	1
	DIIL	Monitoring function is active and it reads the status indication through DIIL (<i>110.02 DI delayed status</i> , bit 15).	2
	DI1	Monitoring function is active and it reads the status indication through DI1 (<i>110.02 DI delayed status</i> , bit 0).	3
	DI2	Monitoring function is active and it reads the status indication through DI2 (<i>110.02 DI delayed status</i> , bit 1).	4
	DI3	Monitoring function is active and it reads the status indication through DI3 (<i>110.02 DI delayed status</i> , bit 2).	5
	DI4	Monitoring function is active and it reads the status indication through DI4 (<i>110.02 DI delayed status</i> , bit 3).	6
	DI5	Monitoring function is active and it reads the status indication through DI5 (<i>110.02 DI delayed status</i> , bit 4).	7
	DI6	Monitoring function is active and it reads the status indication through DI6 (<i>110.02 DI delayed status</i> , bit 5).	8
	DIO1	Monitoring function is active and it reads the status indication through DIO1 (<i>111.02 DIO delayed status</i> , bit 0).	11
	DIO2	Monitoring function is active and it reads the status indication through DIO2 (<i>111.02 DIO delayed status</i> , bit 1).	12
	<i>Other</i>	Source selection (see <i>Terms and abbreviations</i> on page 41).	-

No.	Name/Value	Description	Def/FbEq16																								
131.40	<i>Disable warning messages</i>	Selects warnings to be suppressed. The parameter is a 16-bit word with each bit corresponding to a warning. Whenever a bit is set to 1, the corresponding warning is suppressed. The bits of this binary number correspond to the following warnings:	0000b																								
<table border="1"> <thead> <tr> <th>Bit</th> <th>Name</th> </tr> </thead> <tbody> <tr> <td>0</td> <td>Reserved.</td> </tr> <tr> <td>1</td> <td>Reserved.</td> </tr> <tr> <td>2</td> <td>Reserved.</td> </tr> <tr> <td>3</td> <td>Reserved.</td> </tr> <tr> <td>4</td> <td>CU (Control unit) battery</td> </tr> <tr> <td>5...15</td> <td>Reserved.</td> </tr> </tbody> </table>				Bit	Name	0	Reserved.	1	Reserved.	2	Reserved.	3	Reserved.	4	CU (Control unit) battery	5...15	Reserved.										
Bit	Name																										
0	Reserved.																										
1	Reserved.																										
2	Reserved.																										
3	Reserved.																										
4	CU (Control unit) battery																										
5...15	Reserved.																										
0000h...FFFFh		Warning suppression word.	1 = 1																								
133 Generic timer & counter		Configuration of maintenance timers/counters. See also section <i>Maintenance timers and counters</i> (page 29).																									
133.01	<i>Counter status</i>	Displays the maintenance timer/counter status word, indicating which maintenance timers/counters have exceeded their limits. This parameter is read-only.	-																								
<table border="1"> <thead> <tr> <th>Bit</th> <th>Name</th> <th>Description</th> </tr> </thead> <tbody> <tr> <td>0</td> <td>Ontime1</td> <td>1 = On-time timer 1 has reached its preset limit.</td> </tr> <tr> <td>1</td> <td>Ontime2</td> <td>1 = On-time timer 2 has reached its preset limit.</td> </tr> <tr> <td>2</td> <td>Edge1</td> <td>1 = Signal edge counter 1 has reached its preset limit.</td> </tr> <tr> <td>3</td> <td>Edge2</td> <td>1 = Signal edge counter 2 has reached its preset limit.</td> </tr> <tr> <td>4</td> <td>Value1</td> <td>1 = Value counter 1 has reached its preset limit.</td> </tr> <tr> <td>5</td> <td>Value2</td> <td>1 = Value counter 2 has reached its preset limit.</td> </tr> <tr> <td>6...15</td> <td>Reserved</td> <td></td> </tr> </tbody> </table>				Bit	Name	Description	0	Ontime1	1 = On-time timer 1 has reached its preset limit.	1	Ontime2	1 = On-time timer 2 has reached its preset limit.	2	Edge1	1 = Signal edge counter 1 has reached its preset limit.	3	Edge2	1 = Signal edge counter 2 has reached its preset limit.	4	Value1	1 = Value counter 1 has reached its preset limit.	5	Value2	1 = Value counter 2 has reached its preset limit.	6...15	Reserved	
Bit	Name	Description																									
0	Ontime1	1 = On-time timer 1 has reached its preset limit.																									
1	Ontime2	1 = On-time timer 2 has reached its preset limit.																									
2	Edge1	1 = Signal edge counter 1 has reached its preset limit.																									
3	Edge2	1 = Signal edge counter 2 has reached its preset limit.																									
4	Value1	1 = Value counter 1 has reached its preset limit.																									
5	Value2	1 = Value counter 2 has reached its preset limit.																									
6...15	Reserved																										
0000h...FFFFh		Maintenance time/counter status word.	1 = 1																								
133.10	<i>On-time 1 act</i>	Reading of on-time timer 1. Can be reset from the Drive composer PC tool, or from the control panel by keeping Reset depressed for over 3 seconds.	-																								
0 ... 4294967295 s		Reading of on-time timer 1.	1 = 1 s																								
133.11	<i>On-time 1 limit</i>	Sets the warning limit for on-time timer 1.	0 s																								
0 ... 4294967295 s		Warning limit for on-time counter 1.	1 = 1 s																								

No.	Name/Value	Description	Def/FbEq16								
133.12	<i>On-time 1 func</i>	Configures on-time timer 1. This timer runs whenever the signal selected by parameter 133.13 On-time 1 src is on. After the limit set by 133.11 On-time 1 limit is reached, the warning specified by 133.14 On-time 1 warn sel is given (if enabled by this parameter), and the timer reset. The current value of the timer is readable from parameter 133.10 On-time 1 act . Bit 0 of 133.01 Counter status indicates that the time has exceeded the limit.	00b								
<table border="1"> <thead> <tr> <th>Bit</th> <th>Function</th> </tr> </thead> <tbody> <tr> <td>0</td> <td>Counter mode 0 = Loop: If warning is enabled by bit 1, it stays active only for 10 seconds 1 = Saturate: If warning is enabled by bit 1, it stays active until reset</td> </tr> <tr> <td>1</td> <td>Warning enable 0 = Disable: No warning is given when the limit is reached 1 = Enable: A warning is given when the limit is reached</td> </tr> <tr> <td>2...15</td> <td>Reserved</td> </tr> </tbody> </table>				Bit	Function	0	Counter mode 0 = Loop: If warning is enabled by bit 1, it stays active only for 10 seconds 1 = Saturate: If warning is enabled by bit 1, it stays active until reset	1	Warning enable 0 = Disable: No warning is given when the limit is reached 1 = Enable: A warning is given when the limit is reached	2...15	Reserved
Bit	Function										
0	Counter mode 0 = Loop: If warning is enabled by bit 1, it stays active only for 10 seconds 1 = Saturate: If warning is enabled by bit 1, it stays active until reset										
1	Warning enable 0 = Disable: No warning is given when the limit is reached 1 = Enable: A warning is given when the limit is reached										
2...15	Reserved										
	0000h...FFFFh	On-time timer 1 configuration word.	1 = 1								
133.13	<i>On-time 1 src</i>	Selects the signal to be monitored by on-time timer 1.	<i>False</i>								
	False	Constant 0.	0								
	True	Constant 1.	1								
	RO1	Bit 0 of 110.21 RO status (page 56).	2								
	<i>Other [bit]</i>	Source selection (see Terms and abbreviations on page 41).	-								
133.14	<i>On-time 1 warn sel</i>	Selects the warning message for on-time timer 1.	<i>On-time 1</i>								
	On-time 1	AE45 On-time 1 .	0								
	Device clean	AE4B Device clean warning .	6								
	Add cool fan	AE4F Additional cooling fan warning .	7								
	Cabinet fan	AE4D Cabinet fan warning .	8								
	DC-capacitor	AE4C DC capacitor warning .	9								
133.20	<i>On-time 2 act</i>	Reading of on-time timer 2. Can be reset from the Drive composer PC tool, or from the control panel by keeping Reset depressed for over 3 seconds.	-								
	0 ... 4294967295 s	Reading of on-time timer 2.	1 = 1 s								
133.21	<i>On-time 2 limit</i>	Sets the warning limit for on-time timer 2.	0 s								
	0 ... 4294967295 s	Warning limit for on-time counter 2.	1 = 1 s								
133.22	<i>On-time 2 func</i>	Configures on-time timer 2. This timer runs whenever the signal selected by parameter 133.23 On-time 2 src is on. After the limit set by 133.21 On-time 2 limit is reached, the warning specified by 133.24 On-time 2 warn sel is given (if enabled by this parameter), and the timer reset. The current value of the timer is readable from parameter 133.20 On-time 2 act . Bit 1 of 133.01 Counter status indicates that the time has exceeded the limit.	00b								
<table border="1"> <thead> <tr> <th>Bit</th> <th>Function</th> </tr> </thead> <tbody> <tr> <td>0</td> <td>Counter mode 0 = Loop: If warning is enabled by bit 1, it stays active only for 10 seconds 1 = Saturate: If warning is enabled by bit 1, it stays active until reset</td> </tr> <tr> <td>1</td> <td>Warning enable 0 = Disable: No warning is given when the limit is reached 1 = Enable: A warning is given when the limit is reached</td> </tr> <tr> <td>2...15</td> <td>Reserved</td> </tr> </tbody> </table>				Bit	Function	0	Counter mode 0 = Loop: If warning is enabled by bit 1, it stays active only for 10 seconds 1 = Saturate: If warning is enabled by bit 1, it stays active until reset	1	Warning enable 0 = Disable: No warning is given when the limit is reached 1 = Enable: A warning is given when the limit is reached	2...15	Reserved
Bit	Function										
0	Counter mode 0 = Loop: If warning is enabled by bit 1, it stays active only for 10 seconds 1 = Saturate: If warning is enabled by bit 1, it stays active until reset										
1	Warning enable 0 = Disable: No warning is given when the limit is reached 1 = Enable: A warning is given when the limit is reached										
2...15	Reserved										
	0000h...FFFFh	On-time timer 2 configuration word.	1 = 1								

No.	Name/Value	Description	Def/FbEq16												
133.23	<i>On-time 2 src</i>	Selects the signal to be monitored by on-time timer 2.	<i>False</i>												
	False	Constant 0.	0												
	True	Constant 1.	1												
	RO1	Bit 0 of 110.21 RO status (page 56).	2												
	<i>Other [bit]</i>	Source selection (see Terms and abbreviations on page 41).	-												
133.24	<i>On-time 2 warn sel</i>	Selects the warning message for on-time timer 2.	<i>On-time 2</i>												
	On-time 2	AE46 On-time 2 .	1												
	Device clean	AE4B Device clean warning .	6												
	Add cool fan	AE4F Additional cooling fan warning .	7												
	Cabinet fan	AE4D Cabinet fan warning .	8												
	DC-capacitor	AE4C DC capacitor warning .	9												
133.30	<i>Edge count 1 act</i>	Reading of signal edge counter 1. Can be reset from the Drive composer PC tool, or from the control panel by keeping Reset depressed for over 3 seconds.	-												
	0...4294967295	Reading of signal edge counter 1.	1 = 1												
133.31	<i>Edge count 1 limit</i>	Sets the warning limit for signal edge counter 1.	0												
	0...4294967295	Warning limit for signal edge counter 1.	1 = 1												
133.32	<i>Edge count 1 func</i>	Configures signal edge counter 1. This counter is incremented every time the signal selected by parameter 133.33 Edge count 1 src switches on or off (or either, depending on the setting of this parameter). A divisor may be applied to the count (see 133.34 Edge count 1 div). After the limit set by 133.31 Edge count 1 limit is reached, the warning specified by 133.35 Edge count 1 warn sel is given (if enabled by this parameter), and the counter reset. The current value of the counter is readable from parameter 133.30 Edge count 1 act . Bit 2 of 133.01 Counter status indicates that the count has exceeded the limit.	0000b												
<table border="1"> <thead> <tr> <th>Bit</th> <th>Function</th> </tr> </thead> <tbody> <tr> <td>0</td> <td>Counter mode 0 = Loop: If warning is enabled by bit 1, it stays active only for 10 seconds 1 = Saturate: If warning is enabled by bit 1, it stays active until reset</td> </tr> <tr> <td>1</td> <td>Warning enable 0 = Disable: No warning is given when the limit is reached 1 = Enable: A warning is given when the limit is reached</td> </tr> <tr> <td>2</td> <td>Count rising edge 0 = Disable: Rising edges are not counted 1 = Enable: Rising edges are counted</td> </tr> <tr> <td>3</td> <td>Count falling edge 0 = Disable: Falling edges are not counted 1 = Enable: Falling edges are counted</td> </tr> <tr> <td>4...15</td> <td>Reserved</td> </tr> </tbody> </table>				Bit	Function	0	Counter mode 0 = Loop: If warning is enabled by bit 1, it stays active only for 10 seconds 1 = Saturate: If warning is enabled by bit 1, it stays active until reset	1	Warning enable 0 = Disable: No warning is given when the limit is reached 1 = Enable: A warning is given when the limit is reached	2	Count rising edge 0 = Disable: Rising edges are not counted 1 = Enable: Rising edges are counted	3	Count falling edge 0 = Disable: Falling edges are not counted 1 = Enable: Falling edges are counted	4...15	Reserved
Bit	Function														
0	Counter mode 0 = Loop: If warning is enabled by bit 1, it stays active only for 10 seconds 1 = Saturate: If warning is enabled by bit 1, it stays active until reset														
1	Warning enable 0 = Disable: No warning is given when the limit is reached 1 = Enable: A warning is given when the limit is reached														
2	Count rising edge 0 = Disable: Rising edges are not counted 1 = Enable: Rising edges are counted														
3	Count falling edge 0 = Disable: Falling edges are not counted 1 = Enable: Falling edges are counted														
4...15	Reserved														
	0000h...FFFFh	Edge counter 1 configuration word.	1 = 1												
133.33	<i>Edge count 1 src</i>	Selects the signal to be monitored by signal edge counter 1.	<i>False</i>												
	False	Constant 0.	0												
	True	Constant 1.	1												
	RO1	Bit 0 of 110.21 RO status (page 56).	2												
	<i>Other [bit]</i>	Source selection (see Terms and abbreviations on page 41).	-												
133.34	<i>Edge count 1 div</i>	Divisor for signal edge counter 1. Determines how many signal edges increment the counter by 1.	1												
	1...4294967295	Divisor for signal edge counter 1.	1= 1												

No.	Name/Value	Description	Def/FbEq16												
133.35	Edge count 1 warn sel	Selects the warning message for signal edge counter 1.	Edge count 1												
	Edge count 1	AE47 Edge counter 1.	2												
	Main contactor	AE43 Main contactor warning.	11												
	Output relay	AE40 Output relay warning.	12												
	Supply unit starts	AE41 Supply unit starts warning.	13												
	Power ups	AE42 Power ups warning.	14												
	DC-charge	AE44 DC charge warning.	15												
133.40	Edge count 2 act	Reading of signal edge counter 2. Can be reset from the Drive composer PC tool, or from the control panel by keeping Reset depressed for over 3 seconds.	-												
	0...4294967295	Reading of signal edge counter 2.	1 = 1												
133.41	Edge count 2 limit	Sets the warning limit for signal edge counter 2.	0												
	0...4294967295	Warning limit for signal edge counter 2.	1 = 1												
133.42	Edge count 2 func	Configures signal edge counter 2. This counter is incremented every time the signal selected by parameter 133.43 Edge count 2 src switches on or off (or either, depending on the setting of this parameter). A divisor may be applied to the count (see 133.44 Edge count 2 div). After the limit set by 133.41 Edge count 2 limit is reached, the warning specified by 133.45 Edge count 2 warn sel is given (if enabled by this parameter), and the counter reset. The current value of the counter is readable from parameter 133.40 Edge count 2 act . Bit 3 of 133.01 Counter status indicates that the count has exceeded the limit.	0000b												
<table border="1"> <thead> <tr> <th>Bit</th> <th>Function</th> </tr> </thead> <tbody> <tr> <td>0</td> <td>Counter mode 0 = Loop: If warning is enabled by bit 1, it stays active only for 10 seconds 1 = Saturate: If warning is enabled by bit 1, it stays active until reset</td> </tr> <tr> <td>1</td> <td>Warning enable 0 = Disable: No warning is given when the limit is reached 1 = Enable: A warning is given when the limit is reached</td> </tr> <tr> <td>2</td> <td>Count rising edge 0 = Disable: Rising edges are not counted 1 = Enable: Rising edges are counted</td> </tr> <tr> <td>3</td> <td>Count falling edge 0 = Disable: Falling edges are not counted 1 = Enable: Falling edges are counted</td> </tr> <tr> <td>4...15</td> <td>Reserved</td> </tr> </tbody> </table>				Bit	Function	0	Counter mode 0 = Loop: If warning is enabled by bit 1, it stays active only for 10 seconds 1 = Saturate: If warning is enabled by bit 1, it stays active until reset	1	Warning enable 0 = Disable: No warning is given when the limit is reached 1 = Enable: A warning is given when the limit is reached	2	Count rising edge 0 = Disable: Rising edges are not counted 1 = Enable: Rising edges are counted	3	Count falling edge 0 = Disable: Falling edges are not counted 1 = Enable: Falling edges are counted	4...15	Reserved
Bit	Function														
0	Counter mode 0 = Loop: If warning is enabled by bit 1, it stays active only for 10 seconds 1 = Saturate: If warning is enabled by bit 1, it stays active until reset														
1	Warning enable 0 = Disable: No warning is given when the limit is reached 1 = Enable: A warning is given when the limit is reached														
2	Count rising edge 0 = Disable: Rising edges are not counted 1 = Enable: Rising edges are counted														
3	Count falling edge 0 = Disable: Falling edges are not counted 1 = Enable: Falling edges are counted														
4...15	Reserved														
	0000h...FFFFh	Edge counter 2 configuration word.	1 = 1												
133.43	Edge count 2 src	Selects the signal to be monitored by signal edge counter 2.	False												
	False	0.	0												
	True	1.	1												
	RO1	Bit 0 of 110.21 RO status (page 56).	2												
	Other [bit]	Source selection (see Terms and abbreviations on page 41).	-												
133.44	Edge count 2 div	Divisor for signal edge counter 2. Determines how many signal edges increment the counter by 1.	1												
	1...4294967295	Divisor for signal edge counter 2.	1 = 1												
133.45	Edge count 2 warn sel	Selects the warning message for signal edge counter 2.	Edge count 2												
	Edge count 2	AE48 Edge counter 2.	3												
	Main contactor	AE43 Main contactor warning.	11												
	Output relay	AE40 Output relay warning.	12												

No.	Name/Value	Description	Def/FbEq16								
	Supply unit starts	AE41 Supply unit starts warning.	13								
	Power ups	AE42 Power ups warning.	14								
	DC-charge	AE44 DC charge warning.	15								
133.50	Value count 1 act	Reading of value counter 1. Can be reset from the Drive composer PC tool, or from the control panel by keeping Reset depressed for over 3 seconds.	-								
	-2147483008 ... 2147483008	Reading of value counter 1.	1 = 1								
133.51	Value count 1 limit	Sets the warning limit for value counter 1.	0								
	-2147483008 ... 2147483008	Warning limit for value counter 1.	1 = 1								
133.52	Value count 1 func	Configures value counter 1. The counter calculates its actual value (133.53) by integrating the monitored value (133.xx) with respect to time. A divisor may be applied to the count (see 133.54 Value count 1 div). When the actual value exceeds the limit set by parameter 133.51 Value count 1 limit , the warning specified by 133.55 Value count 1 warn sel is given (if enabled by this parameter). The signal is sampled at 1-second intervals. Note that the scaled (see the "Def/FbEq16" column at the signal in question) value is used. The current value of the counter is readable from parameter 133.50 Value count 1 act . Bit 4 of 133.01 Counter status indicates that the count has exceeded the limit.	0000b								
		<table border="1"> <thead> <tr> <th>Bit</th> <th>Function</th> </tr> </thead> <tbody> <tr> <td>0</td> <td>Counter mode 0 = Loop: If warning is enabled by bit 1, it stays active only for 10 seconds 1 = Saturate: If warning is enabled by bit 1, it stays active until reset</td> </tr> <tr> <td>1</td> <td>Warning enable 0 = Disable: No warning is given when the limit is reached 1 = Enable: A warning is given when the limit is reached</td> </tr> <tr> <td>2...15</td> <td>Reserved</td> </tr> </tbody> </table>	Bit	Function	0	Counter mode 0 = Loop: If warning is enabled by bit 1, it stays active only for 10 seconds 1 = Saturate: If warning is enabled by bit 1, it stays active until reset	1	Warning enable 0 = Disable: No warning is given when the limit is reached 1 = Enable: A warning is given when the limit is reached	2...15	Reserved	
Bit	Function										
0	Counter mode 0 = Loop: If warning is enabled by bit 1, it stays active only for 10 seconds 1 = Saturate: If warning is enabled by bit 1, it stays active until reset										
1	Warning enable 0 = Disable: No warning is given when the limit is reached 1 = Enable: A warning is given when the limit is reached										
2...15	Reserved										
	0000h...FFFFh	Value counter 1 configuration word.	1 = 1								
133.53	Value count 1 src	Selects the signal to be monitored by value counter 1.	<i>Not selected</i>								
	Not selected	None.	0								
	<i>Other [bit]</i>	Source selection (see Terms and abbreviations on page 41).	-								
133.54	Value count 1 div	Divisor for value counter 1. The value of the monitored signal is divided by this value before integration.	1.000								
	0.001 ... 2147483.000	Divisor for value counter 1.	1 = 1								
133.55	Value count 1 warn sel	Selects the warning message for value counter 1.	<i>Value 1</i>								
	Value 1	AE49 Value counter 1.	4								
133.60	Value count 2 act	Reading of value counter 2. Can be reset from the Drive composer PC tool, or from the control panel by keeping Reset depressed for over 3 seconds.	-								
	-2147483008 ... 2147483008	Reading of value counter 2.	1 = 1								
133.61	Value count 2 limit	Sets the warning limit for value counter 2.	0								
	-2147483008 ... 2147483008	Warning limit for value counter 2.	1 = 1								

No.	Name/Value	Description	Def/FbEq16								
133.62	<i>Value count 2 func</i>	<p>Configures value counter 2. The counter calculates its actual value (133.63) by integrating the monitored value (133.xx) with respect to time. A divisor may be applied to the count (see 133.64 <i>Value count 2 div</i>).</p> <p>When the actual value exceeds the limit set by parameter 133.61 <i>Value count 2 limit</i>, the warning specified by 133.65 <i>Value count 2 warn sel</i> is given (if enabled by this parameter). The signal is sampled at 1-second intervals. Note that the scaled (see the "FbEq" column at the signal in question) value is used.</p> <p>The current value of the counter is readable from parameter 133.60 <i>Value count 2 act</i>. Bit 5 of 133.01 <i>Counter status</i> indicates that the count has exceeded the limit.</p>	0000b								
<table border="1"> <thead> <tr> <th>Bit</th> <th>Function</th> </tr> </thead> <tbody> <tr> <td>0</td> <td> Counter mode 0 = Loop: If warning is enabled by bit 1, it stays active only for 10 seconds 1 = Saturate: If warning is enabled by bit 1, it stays active until reset </td> </tr> <tr> <td>1</td> <td> Warning enable 0 = Disable: No warning is given when the limit is reached 1 = Enable: A warning is given when the limit is reached </td> </tr> <tr> <td>2...15</td> <td>Reserved</td> </tr> </tbody> </table>				Bit	Function	0	Counter mode 0 = Loop: If warning is enabled by bit 1, it stays active only for 10 seconds 1 = Saturate: If warning is enabled by bit 1, it stays active until reset	1	Warning enable 0 = Disable: No warning is given when the limit is reached 1 = Enable: A warning is given when the limit is reached	2...15	Reserved
Bit	Function										
0	Counter mode 0 = Loop: If warning is enabled by bit 1, it stays active only for 10 seconds 1 = Saturate: If warning is enabled by bit 1, it stays active until reset										
1	Warning enable 0 = Disable: No warning is given when the limit is reached 1 = Enable: A warning is given when the limit is reached										
2...15	Reserved										
	0000h...FFFFh	Value counter 2 configuration word.	1 = 1								
133.63	<i>Value count 2 src</i>	Selects the signal to be monitored by value counter 2.	<i>Not selected</i>								
	Not selected	None.	0								
	<i>Other [bit]</i>	Source selection (see <i>Terms and abbreviations</i> on page 41).	-								
133.64	<i>Value count 2 div</i>	Divisor for value counter 2. The value of the monitored signal is divided by this value before integration.	1.000								
	0.001 ... 2147483.000	Divisor for value counter 1.	1 = 1								
133.65	<i>Value count 2 warn sel</i>	Selects the warning message for value counter 2.	<i>Value 2</i>								
	Value 2	<i>AE4A Value counter 2.</i>	5								
136 Load analyzer											
		Peak value and amplitude logger settings. See also section <i>Load analyzer</i> (page 30).									
136.01	<i>PVL signal source</i>	<p>Selects the signal to be monitored by the peak value logger. The signal is filtered using the filtering time specified by parameter 136.02 <i>PVL filter time</i>.</p> <p>The peak value is stored, along with other pre-selected signals at the time, into parameters 136.10...136.15.</p> <p>The peak value logger can be reset using parameter 136.09 <i>Reset loggers</i>. The date and time of the last reset are stored into parameters 136.16 and 136.17 respectively.</p>	DxT modules: <i>Zero</i> , DxT modules: <i>Line current</i>								
	Zero	None (peak value logger disabled).	0								
	DC voltage	DC voltage, 101.01 <i>DC voltage</i>	1								
	Grid voltage	<u>DxT modules only</u> : Grid voltage, 101.09 <i>Grid voltage</i>	2								
	Power	<u>DxT modules only</u> : Power, 101.12 <i>Power</i>	3								
	Line current	<u>DxT modules only</u> : Line current, 101.02 <i>Line current</i>	4								
	Line current %	<u>DxT modules only</u> : Line current %, 101.03 <i>Line current %</i>	5								
	Power %	<u>DxT modules only</u> : Power %, 101.13 <i>Power %</i>	6								
	Converter temperature %	<u>DxT modules only</u> : Converter temperature %, 105.11 <i>Converter temperature %</i>	7								
	Ambient temperature	<u>DxT modules only</u> : 101.70 <i>Ambient temperature percent</i> (page 45).	14								

No.	Name/Value	Description	Def/FbEq16
	<i>Other [bit]</i>	Source selection (see <i>Terms and abbreviations</i> on page 41).	-
136.02	<i>PVL filter time</i>	Peak value logger filtering time. See parameter <i>136.01 PVL signal source</i> .	2.00 s
	0.00 ... 120.00 s	Peak value logger filtering time.	100 = 1 s
136.06	<i>AL2 signal source</i>	Selects the signal to be monitored by amplitude logger 2. The signal is sampled at 200 ms intervals. The results are displayed by parameters <i>136.40...136.49</i> . Each parameter represents an amplitude range, and shows what portion of the samples fall within that range. The signal value corresponding to 100% is defined by parameter <i>136.07 AL2 signal scaling</i> . Amplitude logger 2 can be reset using parameter <i>136.09 Reset loggers</i> . The date and time of the last reset are stored into parameters <i>136.50</i> and <i>136.51</i> respectively. For the selections, see parameter <i>136.01 PVL signal source</i> .	DxD modules: <i>Zero</i> , DxT modules: <i>Ambient temperature</i>
136.07	<i>AL2 signal scaling</i>	Defines the signal value that corresponds to 100% amplitude.	100.00
	0.00 ... 32767.00	Signal value corresponding to 100%.	1 = 1
136.09	<i>Reset loggers</i>	Resets the peak value logger and/or amplitude logger 2. (Amplitude logger 1 cannot be reset.)	<i>Done</i>
	Done	Reset completed or not requested (normal operation).	0
	All	Reset both the peak value logger and amplitude logger 2.	1
	PVL	Reset the peak value logger.	2
	AL2	Reset amplitude logger 2.	3
136.10	<i>PVL peak value</i>	Peak value recorded by the peak value logger.	0.00
	-32768.00 ... 32767.00	Peak value.	1 = 1
136.11	<i>PVL peak date</i>	The date on which the peak value was recorded.	-
	-	Peak occurrence date.	-
136.12	<i>PVL peak time</i>	The time at which the peak value was recorded.	-
	-	Peak occurrence time.	-
136.13	<i>PVL current at peak</i>	Line current at the moment the peak value was recorded.	0.00 A
	-32768.00 ... 32767.00 A	Line current at peak.	1 = 1 A
136.14	<i>PVL DC voltage at peak</i>	Voltage in the intermediate DC circuit at the moment the peak value was recorded.	0.00 V
	0.00 ... 2000.00 V	DC voltage at peak.	10 = 1 V
136.15	<i>PVL power at peak</i>	Power at the moment the peak value was recorded. See parameter <i>101.12 Power</i> .	0.0 kW
	-32768.0... 32767.0 kW	Power at peak.	
136.16	<i>PVL reset date</i>	The date on which the peak value logger was last reset.	-
	-	Last reset date of the peak value logger.	-
136.17	<i>PVL reset time</i>	The time at which the peak value logger was last reset.	-
	-	Last reset time of the peak value logger.	-
136.20	<i>AL1 below 10%</i>	Percentage of samples recorded by amplitude logger 1 that fall between 0 and 10%.	0.00%
	0.00 ... 100.00%	Amplitude logger 1 samples between 0 and 10%.	1 = 1%
136.21	<i>AL1 10 to 20%</i>	Percentage of samples recorded by amplitude logger 1 that fall between 10 and 20%.	0.00%
	0.00 ... 100.00%	Amplitude logger 1 samples between 10 and 20%.	1 = 1%
136.22	<i>AL1 20 to 30%</i>	Percentage of samples recorded by amplitude logger 1 that fall between 20 and 30%.	0.00%
	0.00 ... 100.00%	Amplitude logger 1 samples between 20 and 30%.	1 = 1%

108 Parameters

No.	Name/Value	Description	Def/FbEq16
136.23	<i>AL1 30 to 40%</i>	Percentage of samples recorded by amplitude logger 1 that fall between 30 and 40%.	0.00%
	0.00 ... 100.00%	Amplitude logger 1 samples between 30 and 40%.	1 = 1%
136.24	<i>AL1 40 to 50%</i>	Percentage of samples recorded by amplitude logger 1 that fall between 40 and 50%.	0.00%
	0.00 ... 100.00%	Amplitude logger 1 samples between 40 and 50%.	1 = 1%
136.25	<i>AL1 50 to 60%</i>	Percentage of samples recorded by amplitude logger 1 that fall between 50 and 60%.	0.00%
	0.00 ... 100.00%	Amplitude logger 1 samples between 50 and 60%.	1 = 1%
136.26	<i>AL1 60 to 70%</i>	Percentage of samples recorded by amplitude logger 1 that fall between 60 and 70%.	0.00%
	0.00 ... 100.00%	Amplitude logger 1 samples between 60 and 70%.	1 = 1%
136.27	<i>AL1 70 to 80%</i>	Percentage of samples recorded by amplitude logger 1 that fall between 70 and 80%.	0.00%
	0.00 ... 100.00%	Amplitude logger 1 samples between 70 and 80%.	1 = 1%
136.28	<i>AL1 80 to 90%</i>	Percentage of samples recorded by amplitude logger 1 that fall between 80 and 90%.	0.00%
	0.00 ... 100.00%	Amplitude logger 1 samples between 80 and 90%.	1 = 1%
136.29	<i>AL1 over 90%</i>	Percentage of samples recorded by amplitude logger 1 that exceed 90%.	0.00%
	0.00 ... 100.00%	Amplitude logger 1 samples over 90%.	1 = 1%
136.40	<i>AL2 below 10%</i>	Percentage of samples recorded by amplitude logger 2 that fall between 0 and 10%.	0.00%
	0.00 ... 100.00%	Amplitude logger 2 samples between 0 and 10%.	1 = 1%
136.41	<i>AL2 10 to 20%</i>	Percentage of samples recorded by amplitude logger 2 that fall between 10 and 20%.	0.00%
	0.00 ... 100.00%	Amplitude logger 2 samples between 10 and 20%.	1 = 1%
136.42	<i>AL2 20 to 30%</i>	Percentage of samples recorded by amplitude logger 2 that fall between 20 and 30%.	0.00%
	0.00 ... 100.00%	Amplitude logger 2 samples between 20 and 30%.	1 = 1%
136.43	<i>AL2 30 to 40%</i>	Percentage of samples recorded by amplitude logger 2 that fall between 30 and 40%.	0.00%
	0.00 ... 100.00%	Amplitude logger 2 samples between 30 and 40%.	1 = 1%
136.44	<i>AL2 40 to 50%</i>	Percentage of samples recorded by amplitude logger 2 that fall between 40 and 50%.	0.00%
	0.00 ... 100.00%	Amplitude logger 2 samples between 40 and 50%.	1 = 1%
136.45	<i>AL2 50 to 60%</i>	Percentage of samples recorded by amplitude logger 2 that fall between 50 and 60%.	0.00%
	0.00 ... 100.00%	Amplitude logger 2 samples between 50 and 60%.	1 = 1%
136.46	<i>AL2 60 to 70%</i>	Percentage of samples recorded by amplitude logger 2 that fall between 60 and 70%.	0.00%
	0.00 ... 100.00%	Amplitude logger 2 samples between 60 and 70%.	1 = 1%
136.47	<i>AL2 70 to 80%</i>	Percentage of samples recorded by amplitude logger 2 that fall between 70 and 80%.	0.00%
	0.00 ... 100.00%	Amplitude logger 2 samples between 70 and 80%.	1 = 1%
136.48	<i>AL2 80 to 90%</i>	Percentage of samples recorded by amplitude logger 2 that fall between 80 and 90%.	0.00%
	0.00 ... 100.00%	Amplitude logger 2 samples between 80 and 90%.	1 = 1%
136.49	<i>AL2 over 90%</i>	Percentage of samples recorded by amplitude logger 2 that exceed 90%.	0.00%
	0.00 ... 100.00%	Amplitude logger 2 samples over 90%.	1 = 1%

No.	Name/Value	Description	Def/FbEq16
136.50	<i>AL2 reset date</i>	The date on which amplitude logger 2 was last reset.	-
-	-	Last reset date of amplitude logger 2.	-
136.51	<i>AL2 reset time</i>	The time at which amplitude logger 2 was last reset.	-
-	-	Last reset time of amplitude logger 2.	-
147 Data storage		Parameters that can be written to and read from by using source and target settings of other parameters. Note that there are different storage parameters for different data types. See section <i>Data storage parameters</i> on page 26.	
147.01	<i>Data storage 1 real32</i>	Data storage parameter 1.	0.000
-	-32768.000... 32767.000	32-bit data.	-
147.02	<i>Data storage 2 real32</i>	Data storage parameter 2.	0.000
-	-32768.000... 32767.000	32-bit data.	-
147.03	<i>Data storage 3 real32</i>	Data storage parameter 3.	0.000
-	-32768.000... 32767.000	32-bit data.	-
147.04	<i>Data storage 4 real32</i>	Data storage parameter 4.	0.000
-	-32768.000... 32767.000	32-bit data.	-
147.05	<i>Data storage 5 real32</i>	Data storage parameter 5.	0.000
-	-32768.000... 32767.000	32-bit data.	-
147.06	<i>Data storage 6 real32</i>	Data storage parameter 6.	0.000
-	-32768.000... 32767.000	32-bit data.	-
147.07	<i>Data storage 7 real32</i>	Data storage parameter 7.	0.000
-	-32768.000... 32767.000	32-bit data.	-
147.08	<i>Data storage 8 real32</i>	Data storage parameter 8.	0.000
-	-32768.000... 32767.000	32-bit data.	-
147.11	<i>Data storage 1 int32</i>	Data storage parameter 9.	0
-	-2147483648... 2147483647	32-bit data.	-
147.12	<i>Data storage 2 int32</i>	Data storage parameter 10.	0
-	-2147483648... 2147483647	32-bit data.	-
147.13	<i>Data storage 3 int32</i>	Data storage parameter 11.	0
-	-2147483648... 2147483647	32-bit data.	-
147.14	<i>Data storage 4 int32</i>	Data storage parameter 12.	0
-	-2147483648... 2147483647	32-bit data.	-

110 Parameters

No.	Name/Value	Description	Def/FbEq16
147.15	Data storage 5 int32	Data storage parameter 13.	0
	-2147483648... 2147483647	32-bit data.	-
147.16	Data storage 6 int32	Data storage parameter 14.	0
	-2147483648... 2147483647	32-bit data.	-
147.17	Data storage 7 int32	Data storage parameter 15.	0
	-2147483648... 2147483647	32-bit data.	-
147.18	Data storage 8 int32	Data storage parameter 16.	0
	-2147483648... 2147483647	32-bit data.	-
147.21	Data storage 1 int16	Data storage parameter 17.	0
	-32768...32767	16-bit data.	1 = 1
147.22	Data storage 2 int16	Data storage parameter 18.	0
	-32768...32767	16-bit data.	1 = 1
147.23	Data storage 3 int16	Data storage parameter 19.	0
	-32768...32767	16-bit data.	1 = 1
147.24	Data storage 4 int16	Data storage parameter 20.	0
	-32768...32767	16-bit data.	1 = 1
147.25	Data storage 5 int16	Data storage parameter 21.	0
	-32768...32767	16-bit data.	1 = 1
147.26	Data storage 6 int16	Data storage parameter 22.	0
	-32768...32767	16-bit data.	1 = 1
147.27	Data storage 7 int16	Data storage parameter 23.	0
	-32768...32767	16-bit data.	1 = 1
147.28	Data storage 8 int16	Data storage parameter 24.	0
	-32768...32767	16-bit data.	1 = 1
149 Panel port communication		Communication settings for the control panel port on the supply unit.	
149.01	Node ID number	Defines the node ID of the supply unit. All devices connected to the same panel bus/link must have a dedicated node ID. Note: If you change the setting, new setting takes effect only after parameter 149.06 Refresh settings is switched to <i>Done</i> .	1
	1...32	Node ID.	1 = 1
149.03	Baud rate	Defines the transfer rate of the link. Note: If you change the setting, new setting takes effect only after parameter 149.06 Refresh settings is switched to <i>Done</i> .	<i>230.4 kbps</i>
	38.4 kbps	38.4 kbit/s.	1
	57.6 kbps	57.6 kbit/s.	2
	86.4 kbps	86.4 kbit/s.	3
	115.2 kbps	115.2 kbit/s.	4
	230.4 kbps	230.4 kbit/s.	5
149.04	Communication loss time	Sets a time-out for control panel (or PC tool) communication. If a communication break lasts longer than the time-out, the action specified by parameter 149.05 Communication loss action is taken.	10.0 s
	0.3 ... 3000.0 s	Panel/PC tool communication time-out.	10 = 1 s

No.	Name/Value	Description	Def/FbEq16
149.05	<i>Communication loss action</i>	Selects how the supply unit reacts to a control panel (or PC tool) communication break. Note: If you change the setting, new setting takes effect only after parameter <i>149.06 Refresh settings</i> is switched to <i>Done</i> .	<i>Fault</i>
	No action	Communication break does not cause any actions.	0
	Fault	Supply unit trips on a fault <i>7E01 Panel loss</i> and the unit stops.	1
149.06	<i>Refresh settings</i>	Applies the settings of parameters <i>149.01...149.05</i> . Note: Refreshing may cause a communication break, so reconnecting may be required.	<i>Done</i>
	Done	Refresh done or not requested.	0
	Configure	Refresh parameters <i>149.01...149.05</i> . The value reverts automatically to <i>Done</i> .	1
<i>150 FBA</i>		General settings for fieldbus communication configuration.	
150.01	<i>FBA A enable</i>	Enables/disables communication between the supply unit and fieldbus adapter A, and specifies the slot the adapter is installed into.	<i>Disable</i>
	Disable	Communication between supply unit and fieldbus adapter A disabled.	0
	Option slot 1	Communication between supply unit and fieldbus adapter A enabled. The adapter is in slot 1.	1
	Option slot 2	Communication between supply unit and fieldbus adapter A enabled. The adapter is in slot 2.	2
	Option slot 3	Communication between supply unit and fieldbus adapter A enabled. The adapter is in slot 3.	3
150.02	<i>FBA A comm loss func</i>	Selects how the supply unit reacts upon a fieldbus communication break. The time delay is defined by parameter <i>150.03 FBA A comm loss t out</i> .	<i>No action</i>
	No action	Communication break detection disabled.	0
	Fault	Communication break detection active. Upon a communication break, the diode supply unit trips on a communication fault.	1
	Fault always	The supply unit trips on a communication fault even though no control is expected from the fieldbus.	4
	Warning	The supply unit generates a communication warning even though no control is expected from the fieldbus.	5
150.03	<i>FBA A comm loss t out</i>	Defines the time delay before the action defined by parameter <i>150.02 FBA A comm loss func</i> is taken. Time count starts when the communication link fails to update the message.	0.3 s
	0.3 ... 6553.5 s	Time delay.	10 = 1 s
150.07	<i>FBA A act1 type</i>	Selects the type and scaling of actual value 1 transmitted to the fieldbus network through fieldbus adapter A.	<i>Transparent</i>
	Transparent	No scaling is applied.	1
	General	Generic reference without a specific unit.	2
150.08	<i>FBA A act2 type</i>	Selects the type and scaling of actual value 2 transmitted to the fieldbus network through fieldbus adapter A. For the selections, see parameter <i>150.07 FBA A act1 type</i> .	<i>Transparent</i>
150.10	<i>FBA A act1 transparent source</i>	When parameter <i>150.07 FBA A act1 type</i> is set to <i>Transparent</i> , this parameter selects the source of actual value 1 transmitted to the fieldbus network through fieldbus adapter A.	<i>Not selected</i>
	Not selected	No source selected.	-
	<i>Other [bit]</i>	Source selection (see <i>Terms and abbreviations</i> on page 41).	-

112 Parameters

No.	Name/Value	Description	Def/FbEq16															
150.11	<i>FBA A act2 transparent source</i>	When parameter 150.08 FBA A act2 type is set to <i>Transparent</i> , this parameter selects the source of actual value 2 transmitted to the fieldbus network through fieldbus adapter A.	<i>Not selected</i>															
	Not selected	No source selected.	-															
	<i>Other [bit]</i>	Source selection (see Terms and abbreviations on page 41).	-															
150.12	<i>FBA A debug mode</i>	Enables the display of raw (unmodified) data received from and sent to fieldbus adapter A in parameters 150.13...150.18 . This functionality should only be used for debugging.	<i>Disable</i>															
	Disable	Display of raw data from fieldbus adapter A disabled.	0															
	Fast	Debug mode is enabled. Cyclical data update is as fast as possible which increases the CPU load on the supply unit.	1															
	Normal	Debug mode is enabled but data update cycle is slow enough to enable normal operations.	2															
150.13	<i>FBA A control word</i>	Displays the control word received from fieldbus adapter A. For the commands assigned to each bit, see chapter Fieldbus control through a fieldbus adapter .	-															
	00000000h ... FFFFFFFFh	Control word received from fieldbus adapter A.	1 = 1															
150.16	<i>FBA A status word</i>	Displays the status word sent to fieldbus adapter A. For the commands assigned to each bit, see chapter Fieldbus control through a fieldbus adapter .	-															
	00000000h ... FFFFFFFFh	Status word sent to fieldbus adapter A.	1 = 1															
150.17	<i>FBA A actual value 1</i>	Displays raw actual value ACT1 sent to fieldbus adapter A.	-															
	-2147483648... 2147483647	Raw ACT1 sent to fieldbus adapter A.	1 = 1															
150.18	<i>FBA A actual value 2</i>	Displays raw actual value ACT2 sent to fieldbus adapter A.	-															
	-2147483648... 2147483647	Raw ACT2 sent to fieldbus adapter A.	1 = 1															
150.21	<i>FBA A timelevel sel</i>	<p>Selects the communication speed for the fieldbus adapter A. In general, lower speeds reduce CPU load. The table below shows the read/write intervals for cyclic and acyclic data with each parameter setting.</p> <table border="1" data-bbox="507 1503 1123 1664"> <thead> <tr> <th>Selection</th> <th>Cyclic*</th> <th>Acyclic**</th> </tr> </thead> <tbody> <tr> <td><i>Monitoring</i></td> <td>10 ms</td> <td>10 ms</td> </tr> <tr> <td><i>Normal</i></td> <td>2 ms</td> <td>10 ms</td> </tr> <tr> <td><i>Fast</i></td> <td>500 µs</td> <td>2 ms</td> </tr> <tr> <td><i>Very fast</i></td> <td>250 µs</td> <td>500 µs</td> </tr> </tbody> </table> <p>*Cyclic data consists of fieldbus Control and Status words, Act1 and Act2. **Acyclic data consists of the parameter data mapped to parameter groups 152 FBA A data in and 153 FBA A data out.</p>	Selection	Cyclic*	Acyclic**	<i>Monitoring</i>	10 ms	10 ms	<i>Normal</i>	2 ms	10 ms	<i>Fast</i>	500 µs	2 ms	<i>Very fast</i>	250 µs	500 µs	<i>Normal</i>
Selection	Cyclic*	Acyclic**																
<i>Monitoring</i>	10 ms	10 ms																
<i>Normal</i>	2 ms	10 ms																
<i>Fast</i>	500 µs	2 ms																
<i>Very fast</i>	250 µs	500 µs																
	Normal	Normal speed.	0															
	Fast	Fast speed.	1															
	Very fast	Very fast speed.	2															
	Monitoring	Low speed. Optimized for PC tool communication and monitoring usage.	3															

No.	Name/Value	Description	Def/FbEq16
150.31	<i>FBA B enable</i>	Enables/disables communication between the supply unit and fieldbus adapter B, and specifies the slot the adapter is installed into.	<i>Disable</i>
	Disable	Communication between supply unit and fieldbus adapter B disabled.	0
	Option slot 1	Communication between supply unit and fieldbus adapter B enabled. The adapter is in slot 1.	1
	Option slot 2	Communication between supply unit and fieldbus adapter B enabled. The adapter is in slot 2.	2
	Option slot 3	Communication between supply unit and fieldbus adapter B enabled. The adapter is in slot 3.	3
150.32	<i>FBA B comm loss func</i>	Selects how the supply unit reacts upon a fieldbus communication break. The time delay is defined by parameter 150.33 FBA B comm loss timeout .	<i>No action</i>
	No action	Communication break detection disabled.	0
	Fault	Communication break detection active. Upon a communication break, the diode supply unit trips on a communication fault.	1
	Fault always	The supply unit trips on a communication fault even though no control is expected from the fieldbus.	4
	Warning	The supply unit generates a communication warning even though no control is expected from the fieldbus.	5
150.33	<i>FBA B comm loss timeout</i>	Defines the time delay before the action defined by parameter 150.32 FBA B comm loss func is taken. Time count starts when the communication link fails to update the message.	0.3 s
	0.3 ... 6553.5 s	Time delay.	10 = 1 s
150.37	<i>FBA B act1 type</i>	Selects the type and scaling of actual value 1 transmitted to the fieldbus network through fieldbus adapter B. For the selections, see parameter 150.07 FBA A act1 type .	<i>Transparent</i>
150.38	<i>FBA B act2 type</i>	Selects the type and scaling of actual value 2 transmitted to the fieldbus network through fieldbus adapter B. For the selections, see parameter 150.07 FBA A act1 type .	<i>Transparent</i>
150.40	<i>FBA B act1 transparent source</i>	When parameter 150.37 FBA B act1 type is set to <i>Transparent</i> , this parameter selects the source of actual value 1 transmitted to the fieldbus network through fieldbus adapter B.	<i>Not selected</i>
	Not selected	No source selected.	-
	<i>Other [bit]</i>	Source selection (see Terms and abbreviations on page 41).	-
150.41	<i>FBA B act2 transparent source</i>	When parameter 150.38 FBA B act2 type is set to <i>Transparent</i> , this parameter selects the source of actual value 2 transmitted to the fieldbus network through fieldbus adapter B.	<i>Not selected</i>
	Not selected	No source selected.	-
	<i>Other [bit]</i>	Source selection (see Terms and abbreviations on page 41).	-
150.42	<i>FBA B debug mode</i>	Enables the display of raw (unmodified) data received from and sent to fieldbus adapter B in parameters 150.43...150.48 . This functionality should only be used for debugging.	<i>Disable</i>
	Disable	Display of raw data from fieldbus adapter B disabled.	0
	Fast	Debug mode is enabled. Cyclical data update is as fast as possible which increases the CPU load on the supply unit.	1
	Normal	Debug mode is enabled but data update cycle is slow enough to enable normal operations.	2

No.	Name/Value	Description	Def/FbEq16															
150.43	<i>FBA B control word</i>	Displays the control word received from fieldbus adapter B. For the commands assigned to each bit, see chapter <i>Fieldbus control through a fieldbus adapter</i> .	-															
	00000000h ... FFFFFFFFh	Control word received from fieldbus adapter B.	1 = 1															
150.46	<i>FBA B status word</i>	Displays the status word sent to fieldbus adapter B. For the commands assigned to each bit, see chapter <i>Fieldbus control through a fieldbus adapter</i> .	-															
	00000000h ... FFFFFFFFh	Status word sent to fieldbus adapter B.	1 = 1															
150.47	<i>FBA B actual value 1</i>	Displays raw actual value ACT1 sent to fieldbus adapter B.	-															
	-2147483648 ... 2147483647	Raw ACT1 sent to fieldbus adapter B.	1 = 1															
150.48	<i>FBA B actual value 2</i>	Displays raw actual value ACT2 sent to fieldbus adapter B.	-															
	-2147483648 ... 2147483647	Raw ACT2 sent to fieldbus adapter B.	1 = 1															
150.51	<i>FBA B timelevel sel</i>	<p>Selects the communication speed for the fieldbus adapter B. In general, lower speeds reduce CPU load. The table below shows the read/write intervals for cyclic and acyclic data with each parameter setting.</p> <table border="1" style="margin-left: auto; margin-right: auto;"> <thead> <tr> <th>Selection</th> <th>Cyclic*</th> <th>Acyclic**</th> </tr> </thead> <tbody> <tr> <td><i>Monitoring</i></td> <td>10 ms</td> <td>10 ms</td> </tr> <tr> <td><i>Normal</i></td> <td>2 ms</td> <td>10 ms</td> </tr> <tr> <td><i>Fast</i></td> <td>500 µs</td> <td>2 ms</td> </tr> <tr> <td><i>Very fast</i></td> <td>250 µs</td> <td>500 µs</td> </tr> </tbody> </table> <p>*Cyclic data consists of fieldbus Control and Status words, Act1 and Act2. **Acyclic data consists of the parameter data mapped to parameter groups <i>155 FBA B data in</i> and <i>156 FBA B data out</i>.</p>	Selection	Cyclic*	Acyclic**	<i>Monitoring</i>	10 ms	10 ms	<i>Normal</i>	2 ms	10 ms	<i>Fast</i>	500 µs	2 ms	<i>Very fast</i>	250 µs	500 µs	<i>Normal</i>
Selection	Cyclic*	Acyclic**																
<i>Monitoring</i>	10 ms	10 ms																
<i>Normal</i>	2 ms	10 ms																
<i>Fast</i>	500 µs	2 ms																
<i>Very fast</i>	250 µs	500 µs																
	Normal	Normal speed.	0															
	Fast	Fast speed.	1															
	Very fast	Very fast speed.	2															
	Monitoring	Low speed. Optimized for PC tool communication and monitoring usage.	3															
151 FBA A settings		Fieldbus adapter A configuration.																
151.01	<i>FBA A type</i>	<p>Displays the type of the connected fieldbus adapter module.</p> <p>0 = Module is not found or is not properly connected, or is disabled by parameter <i>150.01 FBA A enable</i>; 1 = FPBA; 32 = FCAN; 37 = FDNA; 101 = FCNA; 128 = FENA-11/21; 132 = PROFINET IO; 135 = FECA; 136 = FEPL; 485 = FSCA.</p> <p>Note: All types of the fieldbus adapter modules are not necessarily supported yet.</p> <p>This parameter is read-only.</p>	-															
151.02	<i>FBA A Par2</i>	Parameters <i>151.02...151.26</i> are adapter module-specific. For more information, see the documentation of the fieldbus adapter module. Note that not all of these parameters are necessarily used.	-															
	0...65535	Fieldbus adapter configuration parameter.	1 = 1															
...															

No.	Name/Value	Description	Def/FbEq16
151.26	<i>FBA A Par26</i>	See parameter <i>151.02 FBA A Par2</i> .	-
	0...65535	Fieldbus adapter configuration parameter.	1 = 1
151.27	<i>FBA A par refresh</i>	Validates any changed fieldbus adapter module configuration settings. After refreshing, the value reverts automatically to <i>Done</i> . Note: This parameter cannot be changed while the diode supply unit is running.	<i>Done</i>
	Done	Refreshing done.	0
	Configure	Refreshing.	1
151.28	<i>FBA A par table ver</i>	Displays the parameter table revision of the fieldbus adapter module mapping file stored in the memory. In format axyz, where a = major revision number; xy = minor revision number; z = correction number.	-
	0000h...FFFFh	Parameter table revision of adapter module.	1 = 1
151.29	<i>FBA A drive type code</i>	Displays the type code of the fieldbus adapter module mapping file stored in the memory.	-
	0...65535	Type code of fieldbus adapter module mapping file.	1 = 1
151.30	<i>FBA A mapping file ver</i>	Displays the fieldbus adapter module mapping file revision stored in the memory of the supply unit in decimal format. Example: 0x107 = revision 1.07.	-
	0...65535	Mapping file revision.	1 = 1
151.31	<i>D2FBA A comm status</i>	Displays the status of the fieldbus adapter module communication.	<i>Idle</i>
	Idle	Adapter is not configured.	0
	Exec.init	Adapter is initializing.	1
	Time out	A time-out has occurred in the communication between the adapter and the supply unit.	2
	Conf.err	Adapter configuration error: the major or minor revision code of the common program revision in the fieldbus adapter module is not the revision required by the module (see parameter <i>151.32 FBA A comm SW ver</i>), or mapping file upload has failed more than three times.	3
	Off-line	Adapter is off-line.	4
	On-line	Adapter is on-line.	5
	Reset	Adapter is performing a hardware reset.	6
151.32	<i>FBA A comm SW ver</i>	Displays the common program revision of the adapter module in format axyz, where a = major revision number, xy = minor revision number, z = correction number. Example: 190A = revision 1.90A.	-
		Common program revision of adapter module.	1 = 1
151.33	<i>FBA A appl SW ver</i>	Displays the application program revision of the adapter module in format axyz, where a = major revision number, xy = minor revision number, z = correction number. Example: 190A = revision 1.90A.	-
		Application program version of adapter module.	1 = 1

No.	Name/Value	Description	Def/FbEq16
152 FBA A data in		Selection of data to be transferred from supply unit to fieldbus controller through fieldbus adapter A. Note: 32-bit values require two consecutive parameters. Whenever a 32-bit value is selected in a data parameter, the next parameter is automatically reserved.	
152.01	FBA A data in1	Parameters 152.01...152.12 select data to be transferred from the supply unit to the fieldbus controller through fieldbus adapter A.	<i>None</i>
	None	None.	0
	CW 16bit	Control word (16 bits)	1
	SW 16bit	Status word (16 bits)	4
	Act1 16bit	Actual value ACT1 (16 bits)	5
	Act2 16bit	Actual value ACT2 (16 bits)	6
	CW 32bit	Control word (32 bits)	11
	SW 32bit	Status word (32 bits)	14
	Act1 32bit	Actual value ACT1 (32 bits)	15
	Act2 32bit	Actual value ACT2 (32 bits)	16
	Other	The value is taken from another parameter.	
...
152.12	FBA A data in12	See parameter 152.01 FBA A data in1 .	<i>None</i>
153 FBA A data out		Selection of data to be transferred from fieldbus controller to the diode supply unit through fieldbus adapter A. Note: 32-bit values require two consecutive parameters. Whenever a 32-bit value is selected in a data parameter, the next parameter is automatically reserved.	
153.01	FBA data out1	Parameters 153.01...153.12 select data to be transferred from the fieldbus controller to the supply unit through fieldbus adapter A.	<i>None</i>
	None	None.	0
	CW 16bit	Control word (16 bits)	1
	CW 32bit	Control word (32 bits)	11
	Other	The value is taken from another parameter.	-
...
153.12	FBA data out12	See parameter 153.01 FBA data out1 .	<i>None</i>
154 FBA B settings		Fieldbus adapter B configuration.	
154.01	FBA B type	Displays the type of the connected fieldbus adapter module. 0 = Module is not found or is not properly connected, or is disabled by parameter 150.31 FBA B enable ; 1 = FPBA; 32 = FCAN; 37 = FDNA; 101 = FCNA; 128 = FENA-11/21; 132 = PROFINET IO; 135 = FECA; 136 = FEPL; 485 = FSCA. Note: All types of the fieldbus adapter modules are not necessarily supported yet. This parameter is read-only.	-
154.02	FBA B Par2	Parameters 154.02...154.26 are adapter module-specific. For more information, see the documentation of the fieldbus adapter module. Note that not all of these parameters are necessarily used.	-
	0...65535	Fieldbus adapter configuration parameter.	1 = 1
...

No.	Name/Value	Description	Def/FbEq16
154.26	<i>FBA B Par26</i>	See parameter <i>154.26 FBA B Par2</i> .	-
	0...65535	Fieldbus adapter configuration parameter.	1 = 1
154.27	<i>FBA B par refresh</i>	Validates any changed fieldbus adapter module configuration settings. After refreshing, the value reverts automatically to <i>Done</i> . Note: This parameter cannot be changed while the diode supply unit is running.	<i>Done</i>
	Done	Refreshing done.	0
	Configure	Refreshing.	1
154.28	<i>FBA B par table ver</i>	Displays the parameter table revision of the fieldbus adapter module mapping file stored in the memory. In format axyz, where a = major revision number; xy = minor revision number; z = correction number.	-
		Parameter table revision of adapter module.	1 = 1
154.29	<i>FBA B drive type code</i>	Displays the type code of the fieldbus adapter module mapping file stored in the memory.	-
	0...65535	Type code of fieldbus adapter module mapping file.	1 = 1
154.30	<i>FBA B mapping file ver</i>	Displays the fieldbus adapter module mapping file revision stored in the memory of the supply unit in decimal format. Example: Integer 263 -> 0x107 = revision 1.07	-
	0...65535	Mapping file revision.	1 = 1
154.32	<i>FBA B comm SW ver</i>	Displays the common program revision of the adapter module in format axyz, where a = major revision number, xy = minor revision number, z = correction number. Example: 190A = revision 1.90A.	-
		Common program revision of adapter module.	1 = 1
154.33	<i>FBA B appl SW ver</i>	Displays the application program revision of the adapter module in format axyz, where a = major revision number, xy = minor revision number, z = correction number or letter. Example: 190A = revision 1.90A.	-
		Application program version of adapter module.	1 = 1
<i>155 FBA B data in</i>		Selection of data to be transferred from the diode supply unit to fieldbus controller through fieldbus adapter B. Note: 32-bit values require two consecutive parameters. Whenever a 32-bit value is selected in a data parameter, the next parameter is automatically reserved.	
155.01	<i>FBA B data in1</i>	Parameters <i>155.01...155.12</i> select data to be transferred from the supply unit to the fieldbus controller through fieldbus adapter B.	<i>None</i>
	None	None.	0
	CW 16bit	Control word (16 bits)	1
	SW 16bit	Status word (16 bits)	4
	Act1 16bit	Actual value ACT1 (16 bits)	5
	Act2 16bit	Actual value ACT2 (16 bits)	6
	CW 32bit	Control word (32 bits)	11
	SW 32bit	Status word (32 bits)	14
	Act1 32bit	Actual value ACT1 (32 bits)	15
	Act2 32bit	Actual value ACT2 (32 bits)	16
	Other	The value is taken from another parameter.	-
...	
155.12	<i>FBA B data in12</i>	See parameter <i>155.01 FBA B data in1</i> .	<i>None</i>

118 Parameters

No.	Name/Value	Description	Def/FbEq16
<i>156 FBA B data out</i>		Selection of data to be transferred from fieldbus controller to the diode supply unit through fieldbus adapter B. Note: 32-bit values require two consecutive parameters. Whenever a 32-bit value is selected in a data parameter, the next parameter is automatically reserved.	
<i>156.01</i>	<i>FBA B data out1</i>	Parameters <i>156.01...156.12</i> select data to be transferred from the fieldbus controller to the supply unit through fieldbus adapter B.	<i>None</i>
	None	None.	0
	CW 16bit	Control word (16 bits)	1
	CW 32bit	Control word (32 bits)	11
	Other	The value is taken from another parameter.	-
...
<i>156.12</i>	<i>FBA B data out12</i>	See parameter <i>156.01 FBA B data out1</i> .	<i>None</i>
<i>160 DDCS communication</i>		DDCS communication configuration.	
<i>160.41</i>	<i>Extension adapter com port</i>	Selects the channel used for connecting an optional FEA-xx extension adapter.	<i>Not in use</i>
	Not in use	None (communication disabled).	0
	Slot 1A	Channel A on FDCO module in slot 1 (with ZCU control unit only).	1
	Slot 2A	Channel A on FDCO module in slot 2 (with ZCU control unit only).	2
	Slot 3A	Channel A on FDCO module in slot 3 (with ZCU control unit only).	3
	Slot 1B	Channel B on FDCO module in slot 1 (with ZCU control unit only).	4
	Slot 2B	Channel B on FDCO module in slot 2 (with ZCU control unit only).	5
	Slot 3B	Channel B on FDCO module in slot 3 (with ZCU control unit only).	6
	RDCO CH 3	Channel 3 on RDCO module (with BCU control unit only).	13
<i>160.51</i>	<i>DDCS controller comm port</i>	Selects the DDCS channel used for connecting an external controller (such as an AC 800M or ACS880 inverter).	<i>No connect</i>
	No connect	None (communication disabled).	0
	Slot 1A	Channel A on FDCO module in slot 1 (with ZCU control unit only).	1
	Slot 2A	Channel A on FDCO module in slot 2 (with ZCU control unit only).	2
	Slot 3A	Channel A on FDCO module in slot 3 (with ZCU control unit only).	3
	Slot 1B	Channel B on FDCO module in slot 1 (with ZCU control unit only).	4
	Slot 2B	Channel B on FDCO module in slot 2 (with ZCU control unit only).	5
	Slot 3B	Channel B on FDCO module in slot 3 (with ZCU control unit only).	6
	XD2D	Connector XD2D.	7
	RDCO CH 0	Channel 0 on RDCO module (with BCU control unit only).	11

No.	Name/Value	Description	Def/FbEq16
160.52	<i>DDCS controller node address</i>	Selects the node address for communication with the external controller. No two nodes on-line may have the same address.	1
	1...254	Node address.	1 = 1
160.55	<i>DDCS controller HW connection</i>	Selects the topology of the fiber optic link.	<i>Star</i>
	Ring	The devices are connected in a ring topology. Forwarding of messages is enabled.	0
	Star	The devices are connected in a star topology (for example, through a branching unit). Forwarding of messages is disabled.	1
160.57	<i>DDCS controller link control</i>	Defines the light intensity of the transmission LED of RDCO module channel CH0. (This parameter is effective only when parameter <i>160.51 DDCS controller comm port</i> is set to <i>RDCO CH 0</i> . FDCO modules have a hardware transmitter current selector.) In general, use higher values with longer fiber optic cables. The maximum setting is applicable to the maximum length of the fiber optic link.	10
	1...15	Light intensity.	1 = 1
160.58	<i>DDCS controller comm loss time</i>	Sets a time-out for communication with the external controller. If a communication break lasts longer than the time-out, the action specified by parameter <i>160.59 DDCS controller comm loss action</i> is taken.	100 ms
	0 ... 60000 ms	Time-out for communication with external controller.	1 = 1
160.59	<i>DDCS controller comm loss action</i>	Selects how the supply unit reacts to a communication break between it and the external controller.	<i>Fault</i>
	No action	No action taken.	0
	Fault	Supply unit trips on <i>7E11 DDCS controller comm loss</i> .	1
	Warning	Supply unit generates an <i>AE6D DDCS controller comm loss</i> warning. This occurs even though no control is expected from the external controller.  WARNING! Make sure that it is safe to continue operation in case of a communication break.	5
160.64	<i>Mailbox dataset selection</i>	Selects dataset pair to be used in mailbox communication.	<i>Dataset 32/33</i>
	Dataset 32/33	Dataset 32 is used for query and dataset 33 for response.	0
	Dataset 24/25	Dataset 24 is used for query and dataset 25 for response	1
<i>161 DDCS transmit</i>		Defines the data sent to the DDCS link.	
161.51	<i>Data set 11 data 1 selection</i>	Selects the location where the value of data set 11 data word 1 is read from.	<i>None</i>
	None	None.	0
	CW 16bit	Virtual address for 16-bit control word.	1
	SW 16bit	Virtual address for 16-bit status word.	4
	<i>Other</i>	Source selection (see <i>Terms and abbreviations</i> on page 41).	-
161.52	<i>Data set 11 data 2 selection</i>	Selects the location where the value of data set 11 data word 2 is read from. For the selections, see parameter <i>161.51 Data set 11 data 1 selection</i> .	<i>None</i>
161.53	<i>Data set 11 data 3 selection</i>	Selects the location where the value of data set 11 data word 3 is read from. For the selections, see parameter <i>161.51 Data set 11 data 1 selection</i> .	<i>None</i>

120 Parameters

No.	Name/Value	Description	Def/FbEq16
161.54	Data set 13 data 1 selection	Selects the location where the value of data set 13 data word 1 is read from. For the selections, see parameter 161.51 Data set 11 data 1 selection .	<i>None</i>
161.55	Data set 13 data 2 selection	Selects the location where the value of data set 13 data word 2 is read from. For the selections, see parameter 161.51 Data set 11 data 1 selection .	<i>None</i>
161.56	Data set 13 data 3 selection	Selects the location where the value of data set 13 data word 3 is read from. For the selections, see parameter 161.51 Data set 11 data 1 selection .	<i>None</i>
161.57	Data set 15 data 1 selection	Selects the location where the value of data set 15 data word 1 is read from. For the selections, see parameter 161.51 Data set 11 data 1 selection .	<i>None</i>
161.58	Data set 15 data 2 selection	Selects the location where the value of data set 15 data word 2 is read from. For the selections, see parameter 161.51 Data set 11 data 1 selection .	<i>None</i>
161.59	Data set 15 data 3 selection	Selects the location where the value of data set 15 data word 3 is read from. For the selections, see parameter 161.51 Data set 11 data 1 selection .	<i>None</i>
161.60	Data set 17 data 1 selection	Selects the location where the value of data set 17 data word 1 is read from. For the selections, see parameter 161.51 Data set 11 data 1 selection .	<i>None</i>
161.61	Data set 17 data 2 selection	Selects the location where the value of data set 17 data word 2 is read from. For the selections, see parameter 161.51 Data set 11 data 1 selection .	<i>None</i>
161.62	Data set 17 data 3 selection	Selects the location where the value of data set 17 data word 3 is read from. For the selections, see parameter 161.51 Data set 11 data 1 selection .	<i>None</i>
161.63	Data set 19 data 1 selection	Selects the location where the value of data set 19 data word 1 is read from. For the selections, see parameter 161.51 Data set 11 data 1 selection .	<i>None</i>
161.64	Data set 19 data 2 selection	Selects the location where the value of data set 19 data word 2 is read from. For the selections, see parameter 161.51 Data set 11 data 1 selection .	<i>None</i>
161.65	Data set 19 data 3 selection	Selects the location where the value of data set 19 data word 3 is read from. For the selections, see parameter 161.51 Data set 11 data 1 selection .	<i>None</i>
161.66	Data set 21 data 1 selection	Selects the location where the value of data set 21 data word 1 is read from. For the selections, see parameter 161.51 Data set 11 data 1 selection .	<i>None</i>

No.	Name/Value	Description	Def/FbEq16
161.67	Data set 21 data 2 selection	Selects the location where the value of data set 21 data word 2 is read from. For the selections, see parameter 161.51 Data set 11 data 1 selection .	None
161.68	Data set 21 data 3 selection	Selects the location where the value of data set 21 data word 3 is read from. For the selections, see parameter 161.51 Data set 11 data 1 selection .	None
161.69	Data set 23 data 1 selection	Selects the location where the value of data set 23 data word 1 is read from. For the selections, see parameter 161.51 Data set 11 data 1 selection .	None
161.70	Data set 23 data 2 selection	Selects the location where the value of data set 23 data word 2 is read from. For the selections, see parameter 161.51 Data set 11 data 1 selection .	None
161.71	Data set 23 data 3 selection	Selects the location where the value of data set 23 data word 3 is read from. For the selections, see parameter 161.51 Data set 11 data 1 selection .	None
161.72	Data set 25 data 1 selection	Selects the location where the value of data set 25 data word 1 is read from. For the selections, see parameter 161.51 Data set 11 data 1 selection .	None
161.73	Data set 25 data 2 selection	Selects the location where the value of data set 25 data word 2 is read from. For the selections, see parameter 161.51 Data set 11 data 1 selection .	None
161.74	Data set 25 data 3 selection	Selects the location where the value of data set 25 data word 3 is read from. For the selections, see parameter 161.51 Data set 11 data 1 selection .	None
161.101	Data set 11 data 1 value	Defines the raw data to be transmitted in data set 11 data word 1.	0
	0...65535	Raw data to be transmitted in data set 11 data word 1.	1 = 1
161.102	Data set 11 data 2 value	Defines the raw data to be transmitted in data set 11 data word 2.	0
	0...65535	Raw data to be transmitted in data set 11 data word 2.	1 = 1
161.103	Data set 11 data 3 value	Defines the raw data to be transmitted in data set 11 data word 3.	0
	0...65535	Raw data to be transmitted in data set 11 data word 3.	1 = 1
161.104	Data set 13 data 1 value	Defines the raw data to be transmitted in data set 13 data word 1.	0
	0...65535	Raw data to be transmitted in data set 13 data word 1.	1 = 1
161.105	Data set 13 data 2 value	Defines the raw data to be transmitted in data set 13 data word 2.	0
	0...65535	Raw data to be transmitted in data set 13 data word 2.	1 = 1
161.106	Data set 13 data 3 value	Defines the raw data to be transmitted in data set 13 data word 3.	0
	0...65535	Raw data to be transmitted in data set 13 data word 3.	1 = 1
161.107	Data set 15 data 1 value	Defines the raw data to be transmitted in data set 15 data word 1.	0
	0...65535	Raw data to be transmitted in data set 15 data word 1.	1 = 1

122 Parameters

No.	Name/Value	Description	Def/FbEq16
161.108	<i>Data set 15 data 2 value</i>	Defines the raw data to be transmitted in data set 15 data word 2.	0
	0...65535	Raw data to be transmitted in data set 15 data word 2.	1 = 1
161.109	<i>Data set 15 data 3 value</i>	Defines the raw data to be transmitted in data set 15 data word 3.	0
	0...65535	Raw data to be transmitted in data set 15 data word 3.	1 = 1
161.110	<i>Data set 17 data 1 value</i>	Defines the raw data to be transmitted in data set 17 data word 1.	0
	0...65535	Raw data to be transmitted in data set 17 data word 1.	1 = 1
161.111	<i>Data set 17 data 2 value</i>	Defines the raw data to be transmitted in data set 17 data word 2.	0
	0...65535	Raw data to be transmitted in data set 17 data word 2.	1 = 1
161.112	<i>Data set 17 data 3 value</i>	Defines the raw data to be transmitted in data set 17 data word 3.	0
	0...65535	Raw data to be transmitted in data set 17 data word 3.	1 = 1
161.113	<i>Data set 19 data 1 value</i>	Defines the raw data to be transmitted in data set 19 data word 1.	0
	0...65535	Raw data to be transmitted in data set 19 data word 1.	1 = 1
161.114	<i>Data set 19 data 2 value</i>	Defines the raw data to be transmitted in data set 19 data word 2.	0
	0...65535	Raw data to be transmitted in data set 19 data word 2.	1 = 1
161.115	<i>Data set 19 data 3 value</i>	Defines the raw data to be transmitted in data set 19 data word 3.	0
	0...65535	Raw data to be transmitted in data set 19 data word 3.	1 = 1
161.116	<i>Data set 21 data 1 value</i>	Defines the raw data to be transmitted in data set 21 data word 1.	0
	0...65535	Raw data to be transmitted in data set 21 data word 1.	1 = 1
161.117	<i>Data set 21 data 2 value</i>	Defines the raw data to be transmitted in data set 21 data word 2.	0
	0...65535	Raw data to be transmitted in data set 21 data word 2.	1 = 1
161.118	<i>Data set 21 data 3 value</i>	Defines the raw data to be transmitted in data set 21 data word 3.	0
	0...65535	Raw data to be transmitted in data set 21 data word 3.	1 = 1
161.119	<i>Data set 23 data 1 value</i>	Defines the raw data to be transmitted in data set 23 data word 1.	0
	0...65535	Raw data to be transmitted in data set 23 data word 1.	1 = 1
161.120	<i>Data set 23 data 2 value</i>	Defines the raw data to be transmitted in data set 23 data word 2.	0
	0...65535	Raw data to be transmitted in data set 23 data word 2.	1 = 1
161.121	<i>Data set 23 data 3 value</i>	Defines the raw data to be transmitted in data set 23 data word 3.	0
	0...65535	Raw data to be transmitted in data set 23 data word 3.	1 = 1
161.122	<i>Data set 25 data 1 value</i>	Defines the raw data to be transmitted in data set 25 data word 1.	0
	0...65535	Raw data to be transmitted in data set 25 data word 1.	1 = 1
161.123	<i>Data set 25 data 2 value</i>	Defines the raw data to be transmitted in data set 25 data word 2.	0
	0...65535	Raw data to be transmitted in data set 25 data word 2.	1 = 1
161.124	<i>Data set 25 data 3 value</i>	Defines the raw data to be transmitted in data set 25 data word 3.	0
	0...65535	Raw data to be transmitted in data set 25 data word 3.	1 = 1

No.	Name/Value	Description	Def/FbEq16
162 DDCS receive		Mapping of data received through the DDCS link.	
162.51	<i>Data set 10 data 1 selection</i>	Selects the location into which the value of data set 10 data word 1 is written.	<i>None</i>
	None	None.	0
	CW 16bit	Virtual address for 16-bit control word.	1
	External DC meas signal	DxD modules only: External DC voltage measurement signal. Value is stored to parameter <i>120.60 DC voltage external unscaled</i> .	30780
	<i>Other</i>	Source selection (see <i>Terms and abbreviations</i> on page 41).	-
162.52	<i>Data set 10 data 2 selection</i>	Selects the location into which the value of data set 10 data word 2 is written. For the selections, see parameter <i>162.51 Data set 10 data 1 selection</i> .	<i>None</i>
162.53	<i>Data set 10 data 3 selection</i>	Selects the location into which the value of data set 10 data word 3 is written. For the selections, see parameter <i>162.51 Data set 10 data 1 selection</i> .	<i>None</i>
162.54	<i>Data set 12 data 1 selection</i>	Selects the location into which the value of data set 12 data word 1 is written. For the selections, see parameter <i>162.51 Data set 10 data 1 selection</i> .	<i>None</i>
	None	None.	0
	CW 16bit	Virtual address for 16-bit control word.	1
	<i>Other</i>	Source selection (see <i>Terms and abbreviations</i> on page 41).	-
162.55	<i>Data set 12 data 2 selection</i>	Selects the location into which the value of data set 12 data word 2 is written. For the selections, see parameter <i>162.54 Data set 12 data 1 selection</i> .	<i>None</i>
162.56	<i>Data set 12 data 3 selection</i>	Selects the location into which the value of data set 12 data word 3 is written. For the selections, see parameter <i>162.54 Data set 12 data 1 selection</i> .	<i>None</i>
162.57	<i>Data set 14 data 1 selection</i>	Selects the location into which the value of data set 14 data word 1 is written. For the selections, see parameter <i>162.54 Data set 12 data 1 selection</i> .	<i>None</i>
162.58	<i>Data set 14 data 2 selection</i>	Selects the location into which the value of data set 14 data word 2 is written. For the selections, see parameter <i>162.54 Data set 12 data 1 selection</i> .	<i>None</i>
162.59	<i>Data set 14 data 3 selection</i>	Selects the location into which the value of data set 14 data word 3 is written. For the selections, see parameter <i>162.54 Data set 12 data 1 selection</i> .	<i>None</i>
162.60	<i>Data set 16 data 1 selection</i>	Selects the location into which the value of data set 16 data word 1 is written. For the selections, see parameter <i>162.54 Data set 12 data 1 selection</i> .	<i>None</i>
162.61	<i>Data set 16 data 2 selection</i>	Selects the location into which the value of data set 16 data word 2 is written. For the selections, see parameter <i>162.54 Data set 12 data 1 selection</i> .	<i>None</i>

124 Parameters

No.	Name/Value	Description	Def/FbEq16
162.62	<i>Data set 16 data 3 selection</i>	Selects the location into which the value of data set 16 data word 3 is written. For the selections, see parameter 162.54 Data set 12 data 1 selection .	<i>None</i>
162.63	<i>Data set 18 data 1 selection</i>	Selects the location into which the value of data set 18 data word 1 is written. For the selections, see parameter 162.54 Data set 12 data 1 selection .	<i>None</i>
162.64	<i>Data set 18 data 2 selection</i>	Selects the location into which the value of data set 18 data word 2 is written. For the selections, see parameter 162.54 Data set 12 data 1 selection .	<i>None</i>
162.65	<i>Data set 18 data 3 selection</i>	Selects the location into which the value of data set 18 data word 3 is written. For the selections, see parameter 162.54 Data set 12 data 1 selection .	<i>None</i>
162.66	<i>Data set 20 data 1 selection</i>	Selects the location into which the value of data set 20 data word 1 is written. For the selections, see parameter 162.54 Data set 12 data 1 selection .	<i>None</i>
162.67	<i>Data set 20 data 2 selection</i>	Selects the location into which the value of data set 20 data word 2 is written. For the selections, see parameter 162.54 Data set 12 data 1 selection .	<i>None</i>
162.68	<i>Data set 20 data 3 selection</i>	Selects the location into which the value of data set 20 data word 3 is written. For the selections, see parameter 162.54 Data set 12 data 1 selection .	<i>None</i>
162.69	<i>Data set 22 data 1 selection</i>	Selects the location into which the value of data set 22 data word 1 is written. For the selections, see parameter 162.54 Data set 12 data 1 selection .	<i>None</i>
162.70	<i>Data set 22 data 2 selection</i>	Selects the location into which the value of data set 22 data word 2 is written. For the selections, see parameter 162.54 Data set 12 data 1 selection .	<i>None</i>
162.71	<i>Data set 22 data 3 selection</i>	Selects the location into which the value of data set 22 data word 3 is written. For the selections, see parameter 162.54 Data set 12 data 1 selection .	<i>None</i>
162.72	<i>Data set 24 data 1 selection</i>	Selects the location into which the value of data set 24 data word 1 is written. For the selections, see parameter 162.54 Data set 12 data 1 selection .	<i>None</i>
162.73	<i>Data set 24 data 2 selection</i>	Selects the location into which the value of data set 24 data word 2 is written. For the selections, see parameter 162.54 Data set 12 data 1 selection .	<i>None</i>
162.74	<i>Data set 24 data 3 selection</i>	Selects the location into which the value of data set 24 data word 3 is written. For the selections, see parameter 162.54 Data set 12 data 1 selection .	<i>None</i>

No.	Name/Value	Description	Def/FbEq16
162.101	<i>Data set 10 data 1 value</i>	Defines the raw data to be received in data set 10 data word 1.	0
	0...65535	Raw data to be received in data set 10 data word 1.	1 = 1
162.102	<i>Data set 10 data 2 value</i>	Defines the raw data to be received in data set 10 data word 2.	0
	0...65535	Raw data to be received in data set 10 data word 2.	1 = 1
162.103	<i>Data set 10 data 3 value</i>	Defines the raw data to be received in data set 10 data word 3.	0
	0...65535	Raw data to be received in data set 10 data word 3.	1 = 1
162.104	<i>Data set 12 data 1 value</i>	Defines the raw data to be received in data set 12 data word 1.	0
	0...65535	Raw data to be received in data set 12 data word 1.	1 = 1
162.105	<i>Data set 12 data 2 value</i>	Defines the raw data to be received in data set 12 data word 2.	0
	0...65535	Raw data to be received in data set 12 data word 2.	1 = 1
162.106	<i>Data set 12 data 3 value</i>	Defines the raw data to be received in data set 12 data word 3.	0
	0...65535	Raw data to be received in data set 12 data word 3.	1 = 1
162.107	<i>Data set 14 data 1 value</i>	Defines the raw data to be received in data set 14 data word 1.	0
	0...65535	Raw data to be received in data set 14 data word 1.	1 = 1
162.108	<i>Data set 14 data 2 value</i>	Defines the raw data to be received in data set 14 data word 2.	0
	0...65535	Raw data to be received in data set 14 data word 2.	1 = 1
162.109	<i>Data set 14 data 3 value</i>	Defines the raw data to be received in data set 14 data word 3.	0
	0...65535	Raw data to be received in data set 14 data word 3.	1 = 1
162.110	<i>Data set 16 data 1 value</i>	Defines the raw data to be received in data set 16 data word 1.	0
	0...65535	Raw data to be received in data set 16 data word 1.	1 = 1
162.111	<i>Data set 16 data 2 value</i>	Defines the raw data to be received in data set 16 data word 2.	0
	0...65535	Raw data to be received in data set 16 data word 2.	1 = 1
162.112	<i>Data set 16 data 3 value</i>	Defines the raw data to be received in data set 16 data word 3.	0
	0...65535	Raw data to be received in data set 16 data word 3.	1 = 1
162.113	<i>Data set 18 data 1 value</i>	Defines the raw data to be received in data set 18 data word 1.	0
	0...65535	Raw data to be received in data set 18 data word 1.	1 = 1
162.114	<i>Data set 18 data 2 value</i>	Defines the raw data to be received in data set 18 data word 2.	0
	0...65535	Raw data to be received in data set 18 data word 2.	1 = 1
162.115	<i>Data set 18 data 3 value</i>	Defines the raw data to be received in data set 18 data word 3.	0
	0...65535	Raw data to be received in data set 18 data word 3.	1 = 1
162.116	<i>Data set 20 data 1 value</i>	Defines the raw data to be received in data set 20 data word 1.	0
	0...65535	Raw data to be received in data set 20 data word 1.	1 = 1
162.117	<i>Data set 20 data 2 value</i>	Defines the raw data to be received in data set 20 data word 2.	0
	0...65535	Raw data to be received in data set 20 data word 2.	1 = 1

126 Parameters

No.	Name/Value	Description	Def/FbEq16
162.118	<i>Data set 20 data 3 value</i>	Defines the raw data to be received in data set 20 data word 3.	0
	0...65535	Raw data to be received in data set 20 data word 3.	1 = 1
162.119	<i>Data set 22 data 1 value</i>	Defines the raw data to be received in data set 22 data word 1.	0
	0...65535	Raw data to be received in data set 22 data word 1.	1 = 1
162.120	<i>Data set 22 data 2 value</i>	Defines the raw data to be received in data set 22 data word 2.	0
	0...65535	Raw data to be received in data set 22 data word 2.	1 = 1
162.121	<i>Data set 22 data 3 value</i>	Defines the raw data to be received in data set 22 data word 3.	0
	0...65535	Raw data to be received in data set 22 data word 3.	1 = 1
162.122	<i>Data set 24 data 1 value</i>	Defines the raw data to be received in data set 24 data word 1.	0
	0...65535	Raw data to be received in data set 24 data word 1.	1 = 1
162.123	<i>Data set 24 data 2 value</i>	Defines the raw data to be received in data set 24 data word 2.	0
	0...65535	Raw data to be received in data set 24 data word 2.	1 = 1
162.124	<i>Data set 24 data 3 value</i>	Defines the raw data to be received in data set 24 data word 3.	0
	0...65535	Raw data to be received in data set 24 data word 3.	1 = 1
<i>190 Additional actual values</i>		Additional actual values of 6-pulse diode-thyristor bridge or modules connected to first winding of 12-pulse diode supply unit.	
190.06	<i>Main voltage U1-V1</i>	<u>DxT modules only:</u> Main voltage U1-V1 [V].	-
	0.00...2000.00 V	Main voltage U1-V1.	1 = 1 V
190.07	<i>Main voltage V1-W1</i>	<u>DxT modules only:</u> Main voltage V1-W1 [V].	-
	0.00...2000.00 V	Main voltage V1-W1.	1 = 1 V
190.08	<i>Main voltage W1-U1</i>	<u>DxT modules only:</u> Main voltage W1-U1 [V].	-
	0.00...2000.00 V	Main voltage W1-U1.	1 = 1 V
190.40	<i>Phase current U1</i>	<u>DxT modules only:</u> Filtered rms value of measured U1 phase current [A].	-
	0.00...30000.00 A	U1 phase current.	1 = 1 A
190.41	<i>Phase current V1</i>	<u>DxT modules only:</u> Filtered rms value of measured V1 phase current [A].	-
	0.00...30000.00 A	V1 phase current.	1 = 1 A
190.42	<i>Phase current W1</i>	<u>DxT modules only:</u> Filtered rms value of measured W1 phase current [A].	-
	0.00...30000.00 A	W1 phase current.	1 = 1 A
190.70	<i>DC current 1</i>	<u>DxT modules only:</u> Filtered value of calculated DC current 1 [A].	-
	0.00...30000.00 A	Calculated DC current 1.	1 = 1 A
190.71	<i>DC current 1 peak</i>	<u>DxT modules only:</u> Maximum DC current peak value during a grid cycle.	-
	0.00...30000.00 A	Maximum DC current peak value.	1 = 1 A
190.72	<i>DC current 1 fast</i>	<u>DxT modules only:</u> Average DC current during 60 degree period (1/6 of grid cycle) [A].	-
	0.00...30000.00 A	Fast DC current 1.	1 = 1 A
190.73	<i>DC voltage 1 fast</i>	<u>DxT modules only:</u> Average DC voltage during 60 degree period (1/6 of grid cycle) [V].	-
	0.00...2000.00 V	Fast DC voltage 1.	1 = 1 V

No.	Name/Value	Description	Def/FbEq16																																							
192.74	<i>Main voltage 2 fast</i>	<u>DxT modules only:</u> Average main voltage during 60 degree period (1/6 of grid cycle) [V].	-																																							
	0.00...2000.00 V	Main grid voltage 2.	1 = 1 V																																							
192.75	<i>LSU status word 2</i>	<u>DxT modules only:</u> LSU status word 2.	-																																							
		<table border="1"> <thead> <tr> <th>Bit</th> <th>Name</th> <th>Description</th> </tr> </thead> <tbody> <tr> <td>0</td> <td>Phase voltage ok</td> <td>At least one main voltage is normal</td> </tr> <tr> <td>1</td> <td>Grid voltage above limit</td> <td>All main voltages are normal</td> </tr> <tr> <td>2</td> <td>DC voltage above limit</td> <td>DC voltage is normal</td> </tr> <tr> <td>3</td> <td>Not in use</td> <td></td> </tr> <tr> <td>4</td> <td>Synchronized to grid</td> <td>Synchronized to grid and ready run</td> </tr> <tr> <td>5</td> <td>Phase order U-V-W</td> <td>Phase order of grid is U-V-W</td> </tr> <tr> <td>6</td> <td>Phase order W-V-U</td> <td>Phase order of grid is W-V-U</td> </tr> <tr> <td>7</td> <td>Not in use</td> <td></td> </tr> <tr> <td>8</td> <td>Modulating</td> <td>0 = LSU is not modulating. 1 = LSU is modulating.</td> </tr> <tr> <td>9</td> <td>Ready for load</td> <td>0 = Not ready for load. 1 = LSU is charged and ready for load.</td> </tr> <tr> <td>10</td> <td>Regenerating</td> <td>0 = Not regenerating. 1 = LSU is regenerating.</td> </tr> <tr> <td>11...15</td> <td>Not in use</td> <td></td> </tr> </tbody> </table>	Bit	Name	Description	0	Phase voltage ok	At least one main voltage is normal	1	Grid voltage above limit	All main voltages are normal	2	DC voltage above limit	DC voltage is normal	3	Not in use		4	Synchronized to grid	Synchronized to grid and ready run	5	Phase order U-V-W	Phase order of grid is U-V-W	6	Phase order W-V-U	Phase order of grid is W-V-U	7	Not in use		8	Modulating	0 = LSU is not modulating. 1 = LSU is modulating.	9	Ready for load	0 = Not ready for load. 1 = LSU is charged and ready for load.	10	Regenerating	0 = Not regenerating. 1 = LSU is regenerating.	11...15	Not in use		
Bit	Name	Description																																								
0	Phase voltage ok	At least one main voltage is normal																																								
1	Grid voltage above limit	All main voltages are normal																																								
2	DC voltage above limit	DC voltage is normal																																								
3	Not in use																																									
4	Synchronized to grid	Synchronized to grid and ready run																																								
5	Phase order U-V-W	Phase order of grid is U-V-W																																								
6	Phase order W-V-U	Phase order of grid is W-V-U																																								
7	Not in use																																									
8	Modulating	0 = LSU is not modulating. 1 = LSU is modulating.																																								
9	Ready for load	0 = Not ready for load. 1 = LSU is charged and ready for load.																																								
10	Regenerating	0 = Not regenerating. 1 = LSU is regenerating.																																								
11...15	Not in use																																									
	0000h...FFFFh	LSU status word 2.	1 = 1																																							
<i>195 HW configuration</i>		Various hardware-related settings.																																								
195.01	<i>Supply voltage</i>	<p><u>DxT modules:</u> Selects the supply voltage range. This parameter is used by the ACS880 to determine the nominal voltage of the supply network.</p> <p><u>DxD modules:</u> Voltage selection activates the DC link voltage monitoring function and defines the appropriate overvoltage and undervoltage limits for it. When the function is active, the control program monitors the measured voltage through analog input AI2. Note: Select the voltage range (and activate the voltage monitoring function) when the supply unit is equipped with the charging circuit and/or the circuit for the DC link voltage measurement. Note: Do not select the voltage range for the units which are not equipped with a charging circuit or the circuit for the DC link voltage measurement. For example, the cabinet-installed diode supply units ACS880-307 (+A003) do not have or need the circuits as standard.</p>	<i>Not given</i>																																							
	Not given	No voltage defined. DC link voltage monitoring function is not active.	0																																							
	208 ... 240 V	208 ... 240 V.	1																																							
	380 ... 415 V	380 ... 415 V.	2																																							
	440 ... 480 V	440 ... 480 V.	3																																							
	500 V	500 V.	4																																							
	525 ... 600 V	525 ... 600 V.	5																																							
	660 ... 690 V	660 ... 690 V.	6																																							
195.04	<i>Control board supply</i>	<u>DxT modules only:</u> Specifies how the control unit of the diode supply unit is powered.	<i>External 24V</i>																																							
	Internal 24V	The control unit is powered from the power unit it is connected to.	0																																							
	External 24V	The control unit is powered from an external power supply.	1																																							

No.	Name/Value	Description	Def/FbEq16																		
	Redundant external 24V	Redundant supervision of 24 V signal. A warning (AE5C External power signal missing) is generated if the power supply is missing.	2																		
195.13	Reduced run mode	<p><u>DxT modules only:</u> Specifies the number of supply modules available.</p> <p>This parameter must be set if reduced run is required. A value other than 0 activates the reduced run function.</p> <p>If the control program cannot detect the number of modules specified by this parameter, a fault (5E0E Reduced run) is generated.</p> <p>See section Reduced run function (page 38).</p> <p>0 = Reduced run disabled 1...8 = Number of modules available</p>	0																		
	0...65535	Number of modules available.	-																		
195.14	Connected modules	<u>DxT modules only:</u> Shows which of the parallel-connected converter modules have been detected by the control program.	-																		
		<table border="1"> <thead> <tr> <th>Bit</th> <th>Name</th> <th>Description</th> </tr> </thead> <tbody> <tr> <td>0</td> <td>Module 1</td> <td>1 = Module 1 has been detected.</td> </tr> <tr> <td>1</td> <td>Module 2</td> <td>1 = Module 2 has been detected.</td> </tr> <tr> <td>...</td> <td>...</td> <td>...</td> </tr> <tr> <td>11</td> <td>Module 12</td> <td>1 = Module 12 has been detected.</td> </tr> <tr> <td>12...15</td> <td>Reserved.</td> <td></td> </tr> </tbody> </table>	Bit	Name	Description	0	Module 1	1 = Module 1 has been detected.	1	Module 2	1 = Module 2 has been detected.	11	Module 12	1 = Module 12 has been detected.	12...15	Reserved.		
Bit	Name	Description																			
0	Module 1	1 = Module 1 has been detected.																			
1	Module 2	1 = Module 2 has been detected.																			
...																			
11	Module 12	1 = Module 12 has been detected.																			
12...15	Reserved.																				
	0000h...FFFFh	Converter modules connected.	1 = 1																		

No.	Name/Value	Description	Def/FbEq16																					
195.20	<i>HW options word 1</i>	<p>Specifies hardware-related options that require differentiated parameter defaults. Activating a bit in this parameter makes the necessary changes in other parameters. In many cases, the differentiated parameters will also be write-protected.</p> <p>This parameter, as well as the changes in other parameters implemented by it, are not affected by a parameter restore.</p> <p> WARNING! After switching any bits in this word, recheck the values of the affected parameters.</p>	-																					
<table border="1"> <thead> <tr> <th>Bit</th> <th>Name</th> <th>Information</th> </tr> </thead> <tbody> <tr> <td>0...10</td> <td>Reserved.</td> <td></td> </tr> <tr> <td>11</td> <td>INU-DSU communication</td> <td> <p>Enables DDCS communication with ACS880 inverter. Selects DDCS controller as the control source, enables the communication and configures required dataset parameters. Sets parameter:</p> <ul style="list-style-type: none"> • 119.11 Ext1/Ext2 sel to <i>EXT1</i>, • 120.01 Ext1 commands to <i>DDCS controller</i>, • 160.51 DDCS controller comm port to <i>RDCO CH 0</i> (with BCU control unit), or <i>Slot 3A</i> (with ZCU control unit), • 160.52 DDCS controller node address to <i>1</i>, • 161.51 Data set 11 data 1 selection to <i>SW 16bit</i>, • 162.51 Data set 10 data 1 selection to <i>CW 16bit</i>. </td> </tr> <tr> <td>12</td> <td>RO2 for LCU control</td> <td><u>DxD modules only:</u> Sets parameter 110.27 RO2 source to <i>Started</i>.</td> </tr> <tr> <td>13</td> <td>DOL fan</td> <td>Direct-on-line cooling fan is used instead of speed-controlled cooling fan. Disables fan feedback monitoring and changes fan control to ON/OFF type.</td> </tr> <tr> <td>14</td> <td>DIO1 for brake chopper feedback</td> <td><u>DxD modules only:</u> Sets parameter 111.05 DIO1 function to <i>Input</i>, and parameter 131.39 Brake chopper fault source to <i>DIO1</i>.</td> </tr> <tr> <td>15</td> <td>ACS880-07CLC Compact drive</td> <td> <p><u>DxD modules only:</u> Sets parameter</p> <ul style="list-style-type: none"> • 110.24 RO1 source to <i>Charging</i>, • 111.09 DIO2 function to <i>Input</i>, • 120.30 External charge enable to <i>Yes</i>, • 131.32 Aux circuit breaker fault source to <i>DI4</i>, • 131.38 Fuse trip fault source to <i>DIO2</i>, • 162.52 Data set 10 data 2 selection to <i>External DC meas signal</i>, • 195.40 DC voltage source to <i>External measurement signal</i>, • 206.01 I/O bus enable to <i>Yes</i>. <p>Diode supply unit receives DC voltage measurement from the inverter unit through DDCS communication.</p> </td> </tr> </tbody> </table>				Bit	Name	Information	0...10	Reserved.		11	INU-DSU communication	<p>Enables DDCS communication with ACS880 inverter. Selects DDCS controller as the control source, enables the communication and configures required dataset parameters. Sets parameter:</p> <ul style="list-style-type: none"> • 119.11 Ext1/Ext2 sel to <i>EXT1</i>, • 120.01 Ext1 commands to <i>DDCS controller</i>, • 160.51 DDCS controller comm port to <i>RDCO CH 0</i> (with BCU control unit), or <i>Slot 3A</i> (with ZCU control unit), • 160.52 DDCS controller node address to <i>1</i>, • 161.51 Data set 11 data 1 selection to <i>SW 16bit</i>, • 162.51 Data set 10 data 1 selection to <i>CW 16bit</i>. 	12	RO2 for LCU control	<u>DxD modules only:</u> Sets parameter 110.27 RO2 source to <i>Started</i> .	13	DOL fan	Direct-on-line cooling fan is used instead of speed-controlled cooling fan. Disables fan feedback monitoring and changes fan control to ON/OFF type.	14	DIO1 for brake chopper feedback	<u>DxD modules only:</u> Sets parameter 111.05 DIO1 function to <i>Input</i> , and parameter 131.39 Brake chopper fault source to <i>DIO1</i> .	15	ACS880-07CLC Compact drive	<p><u>DxD modules only:</u> Sets parameter</p> <ul style="list-style-type: none"> • 110.24 RO1 source to <i>Charging</i>, • 111.09 DIO2 function to <i>Input</i>, • 120.30 External charge enable to <i>Yes</i>, • 131.32 Aux circuit breaker fault source to <i>DI4</i>, • 131.38 Fuse trip fault source to <i>DIO2</i>, • 162.52 Data set 10 data 2 selection to <i>External DC meas signal</i>, • 195.40 DC voltage source to <i>External measurement signal</i>, • 206.01 I/O bus enable to <i>Yes</i>. <p>Diode supply unit receives DC voltage measurement from the inverter unit through DDCS communication.</p>
Bit	Name	Information																						
0...10	Reserved.																							
11	INU-DSU communication	<p>Enables DDCS communication with ACS880 inverter. Selects DDCS controller as the control source, enables the communication and configures required dataset parameters. Sets parameter:</p> <ul style="list-style-type: none"> • 119.11 Ext1/Ext2 sel to <i>EXT1</i>, • 120.01 Ext1 commands to <i>DDCS controller</i>, • 160.51 DDCS controller comm port to <i>RDCO CH 0</i> (with BCU control unit), or <i>Slot 3A</i> (with ZCU control unit), • 160.52 DDCS controller node address to <i>1</i>, • 161.51 Data set 11 data 1 selection to <i>SW 16bit</i>, • 162.51 Data set 10 data 1 selection to <i>CW 16bit</i>. 																						
12	RO2 for LCU control	<u>DxD modules only:</u> Sets parameter 110.27 RO2 source to <i>Started</i> .																						
13	DOL fan	Direct-on-line cooling fan is used instead of speed-controlled cooling fan. Disables fan feedback monitoring and changes fan control to ON/OFF type.																						
14	DIO1 for brake chopper feedback	<u>DxD modules only:</u> Sets parameter 111.05 DIO1 function to <i>Input</i> , and parameter 131.39 Brake chopper fault source to <i>DIO1</i> .																						
15	ACS880-07CLC Compact drive	<p><u>DxD modules only:</u> Sets parameter</p> <ul style="list-style-type: none"> • 110.24 RO1 source to <i>Charging</i>, • 111.09 DIO2 function to <i>Input</i>, • 120.30 External charge enable to <i>Yes</i>, • 131.32 Aux circuit breaker fault source to <i>DI4</i>, • 131.38 Fuse trip fault source to <i>DIO2</i>, • 162.52 Data set 10 data 2 selection to <i>External DC meas signal</i>, • 195.40 DC voltage source to <i>External measurement signal</i>, • 206.01 I/O bus enable to <i>Yes</i>. <p>Diode supply unit receives DC voltage measurement from the inverter unit through DDCS communication.</p>																						
	0000h...FFFFh	Hardware options configuration word.	1 = 1																					
195.30	<i>Parallel type list filter</i>	<u>DxD modules only:</u> Filters the list of drive/supply unit types listed by parameter 195.31 Parallel connection rating id .	<i>All types</i>																					
	All types	All types listed.	0																					
	-3 (380-415V)	-3 (380...415 V) types listed.	1																					
	-5 (380-500V)	-5 (380...500 V) types listed.	2																					
	-7 (525-690V)	-7 (525...690 V) types listed.	3																					

No.	Name/Value	Description	Def/FbEq16
195.31	<i>Parallel connection rating id</i>	<u>DxT modules only</u> : Defines the drive/supply unit type if it consists of parallel-connected modules. If the drive/supply unit consists of a single module, leave the value at <i>Not selected</i> .	<i>Not selected</i>
	Not selected	The drive/supply unit does not consist of parallel-connected modules, or type not selected.	0
	[Drive/supply unit type]	Drive/supply unit type consisting of parallel-connected modules.	-
195.40	<i>DC voltage source</i>	<u>DxD modules only</u> : Selects the DC voltage source.	<i>A12 scaled value</i>
	A11 scaled value	DC voltage source is A11.	1
	A12 scaled value	DC voltage source is A12.	2
	External measurement signal	DC voltage measurement is received from the inverter unit via fibre optic link. Measurement signal source is parameter <i>120.60 DC voltage external unscaled</i> , and it is multiplied with a scaling coefficient determined by parameter <i>120.61 External DC voltage scale</i> . Note: To use this selection, the supply voltage range must be selected with parameter <i>195.01 Supply voltage</i> .	3
	None	Not selected.	4
<i>196 System</i>		Language selection; pass code; parameter save and restore; control unit reboot; user lock.	
196.01	<i>Language</i>	Selects the language of the parameter interface and other displayed information.	<i>Not selected</i>
	Not selected	No language selected.	0
	English	English.	1033
196.02	<i>Pass code</i>	Pass codes can be entered into this parameter to activate further access levels (see parameter <i>196.03 Access levels active</i>) or to configure the user lock. Entering "358" toggles the parameter lock, which prevents the changing of all other parameters through the control panel or the Drive composer PC tool. Entering the user pass code (by default, "10000000") enables parameters <i>196.100...196.102</i> , which can be used to define a new user pass code and to select the actions that are to be prevented. Entering an invalid pass code will close the user lock if open, ie. hide parameters <i>196.100...196.102</i> . After entering the code, check that the parameters are in fact hidden. Note: You must change the default user pass code to maintain a high level of cybersecurity. <u>Store the code in a safe place – the protection cannot be disabled even by ABB if the code is lost.</u> See also section <i>User lock</i> (page 40).	0
	0...99999999	Pass code.	1 = 1

No.	Name/Value	Description	Def/FbEq16																				
196.03	<i>Access levels active</i>	Shows which access levels have been activated by pass codes entered into parameter <i>196.02 Pass code</i> . <table border="1"> <thead> <tr> <th>Bit</th> <th>Name</th> </tr> </thead> <tbody> <tr> <td>0</td> <td>End user</td> </tr> <tr> <td>1</td> <td>Service</td> </tr> <tr> <td>2</td> <td>Advanced programmer</td> </tr> <tr> <td>3...10</td> <td>Reserved.</td> </tr> <tr> <td>11</td> <td>OEM access level 1</td> </tr> <tr> <td>12</td> <td>OEM access level 2</td> </tr> <tr> <td>13</td> <td>OEM access level 3</td> </tr> <tr> <td>14</td> <td>Parameter lock</td> </tr> <tr> <td>15</td> <td>Reserved.</td> </tr> </tbody> </table>	Bit	Name	0	End user	1	Service	2	Advanced programmer	3...10	Reserved.	11	OEM access level 1	12	OEM access level 2	13	OEM access level 3	14	Parameter lock	15	Reserved.	0000b
Bit	Name																						
0	End user																						
1	Service																						
2	Advanced programmer																						
3...10	Reserved.																						
11	OEM access level 1																						
12	OEM access level 2																						
13	OEM access level 3																						
14	Parameter lock																						
15	Reserved.																						
	0000h...FFFFh	Active access levels.	-																				
196.06	<i>Parameter restore</i>	Restores the original settings of the control program, ie. parameter default values. Note: This parameter cannot be changed while the diode supply unit is running.	<i>Done</i>																				
	Done	Restoring is completed.	0																				
	Restore defs	All parameter values are restored to default values, except fieldbus adapter and drive-to-drive link data.	8																				
	Clear all	All parameter values are restored to default values, including fieldbus adapter configuration data. PC tool communication is interrupted during the restoring. The supply unit CPU is re-booted after the restoring is completed.	62																				
196.07	<i>Parameter save manually</i>	Saves the valid parameter values to permanent memory. Note: A new parameter value is saved automatically when changed from the PC tool or panel but not when altered through a fieldbus adapter connection.	<i>Done</i>																				
	Done	Save completed.	0																				
	Save	Save in progress.	1																				
196.08	<i>Control board boot</i>	Changing the value of this parameter to 1 reboots the control unit. The value reverts to 0 automatically.	0																				
	0...1	1 = Reboot control unit.	1 = 1																				
196.20	<i>Time sync primary source</i>	Defines the 1 st priority external source for synchronization of the unit's time and date.	<i>DDCS Controller</i>																				
	Internal	No external source selected.	0																				
	DDCS Controller	External controller.	1																				
	Fieldbus A or B	Fieldbus interface A or B.	2																				
	Fieldbus A	Fieldbus interface A.	3																				
	Fieldbus B	Fieldbus interface B.	4																				
	Panel link	Control panel, or Drive composer PC tool connected to the control panel.	8																				
	Ethernet tool link	Drive composer PC tool through an FENA-xx module.	9																				
196.24	<i>Full days since 1st Jan 1980</i>	Number of full days passed since beginning of the year 1980. This parameter, together with <i>196.25 Time in minutes within 24 h</i> and <i>196.26 Time in ms within one minute</i> makes it possible to set the date and time in the drive via the parameter interface from a fieldbus or application program. This may be necessary if the fieldbus protocol does not support time synchronization.	-																				
	1...59999	Days since beginning of 1980.	1 = 1																				

No.	Name/Value	Description	Def/FbEq16																																																			
196.25	<i>Time in minutes within 24 h</i>	Number of full minutes passed since midnight. For example, the value 860 corresponds to 2:20 pm. See parameter 196.24 Full days since 1st Jan 1980 .	0 min																																																			
	1...1439	Minutes since midnight.	1 = 1																																																			
196.26	<i>Time in ms within one minute</i>	Number of milliseconds passed since last minute. See parameter 196.24 Full days since 1st Jan 1980 .	0 ms																																																			
	0...59999	Number of milliseconds since last minute.	1 = 1																																																			
196.29	<i>Time sync source status</i>	Time source status word. This parameter is read-only.	-																																																			
<table border="1"> <thead> <tr> <th>Bit</th> <th>Name</th> <th>Description</th> </tr> </thead> <tbody> <tr> <td>0</td> <td>Time tick received</td> <td>1 = 1st priority tick received: Tick has been received from 1st priority source.</td> </tr> <tr> <td>1</td> <td>Aux Time tick received</td> <td>1 = 2nd priority tick received: Tick has been received from 2nd priority source.</td> </tr> <tr> <td>2</td> <td>Tick interval is too long</td> <td>1 = Yes: Tick interval too long (accuracy compromised).</td> </tr> <tr> <td>3</td> <td>DDCS controller</td> <td>1 = Tick received: Tick has been received from an external controller.</td> </tr> <tr> <td>4</td> <td>Master/Follower</td> <td>1 = Tick received: Tick has been received through the master/follower link.</td> </tr> <tr> <td>5</td> <td>Reserved.</td> <td></td> </tr> <tr> <td>6</td> <td>D2D</td> <td>1 = Tick received: Tick has been received through the drive-to-drive link.</td> </tr> <tr> <td>7</td> <td>FbusA</td> <td>1 = Tick received: Tick has been received through fieldbus interface A.</td> </tr> <tr> <td>8</td> <td>FbusB</td> <td>1 = Tick received: Tick has been received through fieldbus interface B.</td> </tr> <tr> <td>9</td> <td>EFB</td> <td>1 = Tick received: Tick has been received through the embedded fieldbus interface.</td> </tr> <tr> <td>10</td> <td>Ethernet</td> <td>1 = Tick received: Tick has been received through the Ethernet port on type BCU control unit.</td> </tr> <tr> <td>11</td> <td>Panel link</td> <td>1 = Tick received: Tick has been received from the control panel, or Drive composer PC tool connected to the control panel.</td> </tr> <tr> <td>12</td> <td>Ethernet tool link</td> <td>1 = Tick received: Tick has been received from Drive composer PC tool through an FENA-xx module.</td> </tr> <tr> <td>13</td> <td>Parameter setting</td> <td>1 = Tick received: Tick has been set by parameters 196.24...196.26.</td> </tr> <tr> <td>14</td> <td>RTC</td> <td>1 = RTC time in use: Time and date have been read from the real-time clock.</td> </tr> <tr> <td>15</td> <td>Drive On-Time</td> <td>1 = Drive on-time in use: Time and date are displaying drive on-time.</td> </tr> </tbody> </table>				Bit	Name	Description	0	Time tick received	1 = 1st priority tick received: Tick has been received from 1st priority source.	1	Aux Time tick received	1 = 2nd priority tick received: Tick has been received from 2nd priority source.	2	Tick interval is too long	1 = Yes: Tick interval too long (accuracy compromised).	3	DDCS controller	1 = Tick received: Tick has been received from an external controller.	4	Master/Follower	1 = Tick received: Tick has been received through the master/follower link.	5	Reserved.		6	D2D	1 = Tick received: Tick has been received through the drive-to-drive link.	7	FbusA	1 = Tick received: Tick has been received through fieldbus interface A.	8	FbusB	1 = Tick received: Tick has been received through fieldbus interface B.	9	EFB	1 = Tick received: Tick has been received through the embedded fieldbus interface.	10	Ethernet	1 = Tick received: Tick has been received through the Ethernet port on type BCU control unit.	11	Panel link	1 = Tick received: Tick has been received from the control panel, or Drive composer PC tool connected to the control panel.	12	Ethernet tool link	1 = Tick received: Tick has been received from Drive composer PC tool through an FENA-xx module.	13	Parameter setting	1 = Tick received: Tick has been set by parameters 196.24...196.26 .	14	RTC	1 = RTC time in use: Time and date have been read from the real-time clock.	15	Drive On-Time	1 = Drive on-time in use: Time and date are displaying drive on-time.
Bit	Name	Description																																																				
0	Time tick received	1 = 1st priority tick received: Tick has been received from 1st priority source.																																																				
1	Aux Time tick received	1 = 2nd priority tick received: Tick has been received from 2nd priority source.																																																				
2	Tick interval is too long	1 = Yes: Tick interval too long (accuracy compromised).																																																				
3	DDCS controller	1 = Tick received: Tick has been received from an external controller.																																																				
4	Master/Follower	1 = Tick received: Tick has been received through the master/follower link.																																																				
5	Reserved.																																																					
6	D2D	1 = Tick received: Tick has been received through the drive-to-drive link.																																																				
7	FbusA	1 = Tick received: Tick has been received through fieldbus interface A.																																																				
8	FbusB	1 = Tick received: Tick has been received through fieldbus interface B.																																																				
9	EFB	1 = Tick received: Tick has been received through the embedded fieldbus interface.																																																				
10	Ethernet	1 = Tick received: Tick has been received through the Ethernet port on type BCU control unit.																																																				
11	Panel link	1 = Tick received: Tick has been received from the control panel, or Drive composer PC tool connected to the control panel.																																																				
12	Ethernet tool link	1 = Tick received: Tick has been received from Drive composer PC tool through an FENA-xx module.																																																				
13	Parameter setting	1 = Tick received: Tick has been set by parameters 196.24...196.26 .																																																				
14	RTC	1 = RTC time in use: Time and date have been read from the real-time clock.																																																				
15	Drive On-Time	1 = Drive on-time in use: Time and date are displaying drive on-time.																																																				
0000h...FFFFh		Time source status word 1.	1 = 1																																																			

134 Parameters

No.	Name/Value	Description	Def/FbEq16																	
196.61	<i>User data logger status word</i>	Provides status information on the user data logger (see page 161).	0000b																	
	<table border="1"> <thead> <tr> <th>Bit</th> <th>Name</th> <th>Description</th> </tr> </thead> <tbody> <tr> <td>0</td> <td>Running</td> <td>1 = The user data logger is running. The bit is cleared after the post-trigger time has passed.</td> </tr> <tr> <td>1</td> <td>Triggered</td> <td>1 = The user data logger has been triggered. The bit is cleared when the logger is restarted.</td> </tr> <tr> <td>2</td> <td>Data available</td> <td>1 = The user data logger contains data that can be read. Note that the bit is not cleared because the data is saved to the memory unit.</td> </tr> <tr> <td>3</td> <td>Configured</td> <td>1 = The user data logger has been configured. Note that the bit is not cleared because the configuration data is saved to the memory unit.</td> </tr> <tr> <td>4...15</td> <td>Reserved</td> <td></td> </tr> </tbody> </table>	Bit	Name	Description	0	Running	1 = The user data logger is running. The bit is cleared after the post-trigger time has passed.	1	Triggered	1 = The user data logger has been triggered. The bit is cleared when the logger is restarted.	2	Data available	1 = The user data logger contains data that can be read. Note that the bit is not cleared because the data is saved to the memory unit.	3	Configured	1 = The user data logger has been configured. Note that the bit is not cleared because the configuration data is saved to the memory unit.	4...15	Reserved		
Bit	Name	Description																		
0	Running	1 = The user data logger is running. The bit is cleared after the post-trigger time has passed.																		
1	Triggered	1 = The user data logger has been triggered. The bit is cleared when the logger is restarted.																		
2	Data available	1 = The user data logger contains data that can be read. Note that the bit is not cleared because the data is saved to the memory unit.																		
3	Configured	1 = The user data logger has been configured. Note that the bit is not cleared because the configuration data is saved to the memory unit.																		
4...15	Reserved																			
	0000b...1111b	User data logger status word.	1 = 1																	
196.63	<i>User data logger trigger</i>	Triggers, or selects a source that triggers, the user data logger.	<i>Off</i>																	
	Off	0.	0																	
	On	1.	1																	
	<i>Other</i>	Source selection (see <i>Terms and abbreviations</i> on page 41).	-																	
196.64	<i>User data logger start</i>	Starts, or selects a source that starts, the user data logger.	<i>Off</i>																	
	Off	0.	0																	
	On	1.	1																	
	<i>Other</i>	Source selection (see <i>Terms and abbreviations</i> on page 41).	-																	
196.65	<i>Factory data logger time level</i>	Selects the sampling interval for the factory data logger (see page 160).	<i>500us</i>																	
	500us	500 microseconds.	500																	
	2ms	2 milliseconds.	2000																	
	10ms	10 milliseconds.	10000																	
196.100	<i>Change user pass code</i>	<i>(Visible when user lock is open)</i> To change the current user pass code, enter a new code into this parameter as well as <i>196.101 Confirm user pass code</i> . A warning will be active until the new pass code is confirmed. To cancel changing the pass code, close the user lock without confirming. To close the lock, enter an invalid pass code in parameter <i>196.02 Pass code</i> , activate parameter <i>196.08 Control board boot</i> , or cycle the power. See also section <i>User lock</i> (page 40).	10000000																	
	10000000... 99999999	New user pass code.	-																	
196.101	<i>Confirm user pass code</i>	<i>(Visible when user lock is open)</i> Confirms the new user pass code entered in <i>196.100 Change user pass code</i> .																		
	10000000... 99999999	Confirmation of new user pass code.	-																	

No.	Name/Value	Description	Def/FbEq16																														
196.102	<i>User lock functionality</i>	<p>(Visible when user lock is open)</p> <p>Selects the actions or functionalities to be prevented by the user lock. Note that the changes made take effect only when the user lock is closed. See parameter 196.02 Pass code.</p> <p>Note: We recommend you select all the actions and functionalities unless otherwise required by the application.</p>	0000h																														
		<table border="1"> <thead> <tr> <th>Bit</th> <th>Name</th> <th>Information</th> </tr> </thead> <tbody> <tr> <td>0</td> <td>Disable ABB access levels</td> <td>1 = ABB access levels (service, advanced programmer, etc.; see 196.03) disabled</td> </tr> <tr> <td>1</td> <td>Freeze parameter lock state</td> <td>1 = Changing the parameter lock state prevented, ie. pass code 358 has no effect</td> </tr> <tr> <td>2</td> <td>Disable file download</td> <td>1 = Loading of files to drive prevented. This applies to <ul style="list-style-type: none"> firmware upgrades safety functions module configuration parameter restore loading an adaptive program loading and debugging an application program changing home view of control panel editing drive texts editing the favorite parameters list on control panel configuration settings made through control panel such as time/date formats and enabling/disabling clock display. </td> </tr> <tr> <td>3</td> <td>Disable FB write to hidden</td> <td>1 = Access to parameters on disabled access levels from fieldbus prevented.</td> </tr> <tr> <td>4...10</td> <td>Reserved</td> <td></td> </tr> <tr> <td>11</td> <td>Disable OEM access level 1</td> <td>1 = OEM access level 1 disabled</td> </tr> <tr> <td>12</td> <td>Disable OEM access level 2</td> <td>1 = OEM access level 2 disabled</td> </tr> <tr> <td>13</td> <td>Disable OEM access level 3</td> <td>1 = OEM access level 3 disabled</td> </tr> <tr> <td>14...15</td> <td>Reserved</td> <td></td> </tr> </tbody> </table>	Bit	Name	Information	0	Disable ABB access levels	1 = ABB access levels (service, advanced programmer, etc.; see 196.03) disabled	1	Freeze parameter lock state	1 = Changing the parameter lock state prevented, ie. pass code 358 has no effect	2	Disable file download	1 = Loading of files to drive prevented. This applies to <ul style="list-style-type: none"> firmware upgrades safety functions module configuration parameter restore loading an adaptive program loading and debugging an application program changing home view of control panel editing drive texts editing the favorite parameters list on control panel configuration settings made through control panel such as time/date formats and enabling/disabling clock display. 	3	Disable FB write to hidden	1 = Access to parameters on disabled access levels from fieldbus prevented.	4...10	Reserved		11	Disable OEM access level 1	1 = OEM access level 1 disabled	12	Disable OEM access level 2	1 = OEM access level 2 disabled	13	Disable OEM access level 3	1 = OEM access level 3 disabled	14...15	Reserved		
Bit	Name	Information																															
0	Disable ABB access levels	1 = ABB access levels (service, advanced programmer, etc.; see 196.03) disabled																															
1	Freeze parameter lock state	1 = Changing the parameter lock state prevented, ie. pass code 358 has no effect																															
2	Disable file download	1 = Loading of files to drive prevented. This applies to <ul style="list-style-type: none"> firmware upgrades safety functions module configuration parameter restore loading an adaptive program loading and debugging an application program changing home view of control panel editing drive texts editing the favorite parameters list on control panel configuration settings made through control panel such as time/date formats and enabling/disabling clock display. 																															
3	Disable FB write to hidden	1 = Access to parameters on disabled access levels from fieldbus prevented.																															
4...10	Reserved																																
11	Disable OEM access level 1	1 = OEM access level 1 disabled																															
12	Disable OEM access level 2	1 = OEM access level 2 disabled																															
13	Disable OEM access level 3	1 = OEM access level 3 disabled																															
14...15	Reserved																																
	0000h...FFFFh	Selection of actions to be prevented by user lock.	-																														
206 I/O bus configuration		Basic configuration of the distributed I/O bus.																															
<u>DxD modules only:</u> This parameter group contains parameters related to basic configuration of the distributed I/O bus. For details on the parameters in this group, see <i>ACS880 distributed I/O bus supplement</i> (3AXD50000126880 [English]).																																	
207 I/O bus service		Distributed I/O bus service.																															
<u>DxD modules only:</u> This parameter group contains parameters related to distributed I/O bus service. For details on the parameters in this group, see <i>ACS880 distributed I/O bus supplement</i> (3AXD50000126880 [English]).																																	
208 I/O bus diagnostics		Diagnostic counters of the distributed I/O bus.																															
<u>DxD modules only:</u> This parameter group contains parameters related to diagnostic counters of the distributed I/O bus. For details on the parameters in this group, see <i>ACS880 distributed I/O bus supplement</i> (3AXD50000126880 [English]).																																	
209 I/O bus fan identification		Fan identification run on the distributed I/O bus.																															
<u>DxD modules only:</u> This parameter group contains parameters related to fan identification run on the distributed I/O bus. For details on the parameters in this group, see <i>ACS880 distributed I/O bus supplement</i> (3AXD50000126880 [English]).																																	

6

Additional parameter data

What this chapter contains

This chapter lists the parameters with some additional data. For parameter descriptions, see chapter [Parameters](#) (page 41).

Terms and abbreviations

Term	Definition
Actual signal	Signal measured or calculated by the supply unit. Usually can only be monitored but not adjusted; some counter-type signals can however be reset by entering the value 0.
Analog src	Parameter can be set to the value of another parameter by choosing Other, and selecting the source parameter from a list. In addition to the Other selection, the parameter may offer other pre-selected settings.
Binary src	Value of the parameter can be taken from a specific bit in another parameter value (Other). Sometimes the value can be fixed to 0 (False) or 1 (True). In addition to the Other, False and True selections, the parameter may offer other pre-selected settings.
Data	Data parameter.
FbEq32	32-bit fieldbus equivalent: Scaling between the value shown on the panel and the integer used in fieldbus communication when a 32-bit value is selected for transmission to an external system. Corresponding 16-bit scalings are listed in chapter Parameters (page 41).
List	Selection list.
No.	Parameter number.
PB	Packed boolean.

Real	$\underbrace{\hspace{1.5cm}}_{\text{16-bit value}} \underbrace{\hspace{1.5cm}}_{\text{16-bit value (31 bits + sign)}}$ = integer value = fractional value
Type	Data type. See Analog src , Binary src , List , PB , Real .

Fieldbus addresses

Refer to the *User's manual* of the fieldbus adapter.

Parameter groups 101...107

No.	Name	Type	Range	Unit	FbEq32
101 Actual values					
101.01	DC voltage	<i>Real</i>	0.00 ... 2000.00	V	100 = 1 V
101.02	Line current	<i>Real</i>	0.00...30000.00	A	100 = 1 A
101.03	Line current %	<i>Real</i>	0.0...1000.0	%	10 = 1%
101.08	Frequency	<i>Real</i>	0.00...100.00	Hz	100 = 1 Hz
101.09	Grid voltage	<i>Real</i>	0.00...2000.00	V	100 = 1 V
101.12	Power	<i>Real</i>	-30000.00...30000.00	kW	100 = 1 kW
101.13	Power %	<i>Real</i>	-1000.0...1000.0	%	10 = 1%
101.22	kWh supply	<i>Real</i>	-1000...1000	kWh	1 = 1 kWh
101.23	MWh supply	<i>Real</i>	-1000...1000	MWh	1 = 1 MWh
101.24	GWh supply	<i>Real</i>	-32768...32767	GWh	1 = 1 GWh
101.31	Ambient temperature	<i>Real</i>	-30000.0...30000.0	°C	10 = 1°C
101.61	Nominal supply voltage	<i>Real</i>	0...2000	V	1 = 1 V
101.62	Nominal DC voltage	<i>Real</i>	0...2000	V	1 = 1 V
101.63	Nominal current	<i>Real</i>	0...30000	A	1 = 1 A
101.64	Nominal power	<i>Real</i>	0...30000	kW	1 = 1 kW
101.70	Ambient temperature percent	<i>Real</i>	-200.00...200.00	%	100 = 1%
104 Warnings and faults					
104.01	Tripping fault	<i>Data</i>	0000h...FFFFh	-	1 = 1
104.02	Active fault 2	<i>Data</i>	0000h...FFFFh	-	1 = 1
104.03	Active fault 3	<i>Data</i>	0000h...FFFFh	-	1 = 1
104.04	Active fault 4	<i>Data</i>	0000h...FFFFh	-	1 = 1
104.05	Active fault 5	<i>Data</i>	0000h...FFFFh	-	1 = 1
104.06	Active warning 1	<i>Data</i>	0000h...FFFFh	-	1 = 1
104.07	Active warning 2	<i>Data</i>	0000h...FFFFh	-	1 = 1
104.08	Active warning 3	<i>Data</i>	0000h...FFFFh	-	1 = 1
104.09	Active warning 4	<i>Data</i>	0000h...FFFFh	-	1 = 1
104.10	Active warning 5	<i>Data</i>	0000h...FFFFh	-	1 = 1
104.11	Latest fault	<i>Data</i>	0000h...FFFFh	-	1 = 1
104.12	2nd latest fault	<i>Data</i>	0000h...FFFFh	-	1 = 1
104.13	3rd latest fault	<i>Data</i>	0000h...FFFFh	-	1 = 1
104.14	4th latest fault	<i>Data</i>	0000h...FFFFh	-	1 = 1
104.15	5th latest fault	<i>Data</i>	0000h...FFFFh	-	1 = 1
104.16	Latest warning	<i>Data</i>	0000h...FFFFh	-	1 = 1
104.17	2nd latest warning	<i>Data</i>	0000h...FFFFh	-	1 = 1
104.18	3rd latest warning	<i>Data</i>	0000h...FFFFh	-	1 = 1
104.19	4th latest warning	<i>Data</i>	0000h...FFFFh	-	1 = 1
104.20	5th latest warning	<i>Data</i>	0000h...FFFFh	-	1 = 1
105 Diagnostics					
105.01	On-time counter	<i>Real</i>	0...65535	d	1 = 1 d
105.02	Run-time counter	<i>Real</i>	0...65535	d	1 = 1 d
105.04	Fan on-time counter	<i>Real</i>	0...65535	d	1 = 1 d
105.11	Converter temperature %	<i>Real</i>	-40.0...160.0	%	10 = 1%
105.21	MCB closing time counter	<i>Real</i>	0...4294967295	-	1 = 1
106 Control and status words					
106.01	Main control word	<i>PB</i>	0000h...FFFFh	-	1 = 1

140 Additional parameter data

No.	Name	Type	Range	Unit	FbEq32
106.03	FBA A transparent control word	<i>PB</i>	00000000h...FFFFFFFFh	-	1 = 1
106.04	FBA B transparent control word	<i>PB</i>	00000000h...FFFFFFFFh	-	1 = 1
106.11	Main status word	<i>PB</i>	0000h...FFFFh	-	1 = 1
106.16	Drive status word 1	<i>PB</i>	0000h...FFFFh	-	1 = 1
106.17	Drive status word 2	<i>PB</i>	0000h...FFFFh	-	1 = 1
106.18	Start inhibit status word	<i>PB</i>	0000h...FFFFh	-	1 = 1
106.25	Drive inhibit status word 2	<i>PB</i>	0000h...FFFFh	-	1 = 1
106.30	MSW bit 11 sel	<i>Binary src</i>	-	-	1 = 1
106.31	MSW bit 12 sel	<i>Binary src</i>	-	-	1 = 1
106.32	MSW bit 13 sel	<i>Binary src</i>	-	-	1 = 1
106.33	MSW bit 15 sel	<i>Binary src</i>	-	-	1 = 1
106.50	User status word 1	<i>PB</i>	-	-	1 = 1
106.60	User status word 1 bit 0 sel	<i>PB</i>	-	-	1 = 1
106.61	User status word 1 bit 1 sel	<i>PB</i>	-	-	1 = 1
106.62	User status word 1 bit 2 sel	<i>PB</i>	-	-	1 = 1
106.63	User status word 1 bit 3 sel	<i>PB</i>	-	-	1 = 1
106.64	User status word 1 bit 4 sel	<i>PB</i>	-	-	1 = 1
106.65	User status word 1 bit 5 sel	<i>PB</i>	-	-	1 = 1
106.66	User status word 1 bit 6 sel	<i>PB</i>	-	-	1 = 1
106.67	User status word 1 bit 7 sel	<i>PB</i>	-	-	1 = 1
106.68	User status word 1 bit 8 sel	<i>PB</i>	-	-	1 = 1
106.69	User status word 1 bit 9 sel	<i>PB</i>	-	-	1 = 1
106.70	User status word 1 bit 10 sel	<i>PB</i>	-	-	1 = 1
106.71	User status word 1 bit 11 sel	<i>PB</i>	-	-	1 = 1
106.72	User status word 1 bit 12 sel	<i>PB</i>	-	-	1 = 1
106.73	User status word 1 bit 13 sel	<i>PB</i>	-	-	1 = 1
106.74	User status word 1 bit 14 sel	<i>PB</i>	-	-	1 = 1
106.75	User status word 1 bit 15 sel	<i>PB</i>	-	-	1 = 1
107 System info					
107.03	Drive rating id	<i>List</i>	0...999	-	1 = 1
107.04	Firmware name	<i>List</i>	-	-	1 = 1
107.05	Firmware version	<i>Data</i>	-	-	1 = 1
107.06	Loading package name	<i>List</i>	-	-	1 = 1
107.07	Loading package version	<i>Data</i>	-	-	1 = 1
107.08	Bootloader version	<i>Data</i>	-	-	1 = 1
107.11	Cpu usage	<i>Real</i>	0...100	%	1 = 1%
107.13	PU logic version number	<i>Data</i>	-	-	1 = 1

Parameter groups 110...209

No.	Name	Type	Range	Unit	FbEq32
110 Standard DI, RO					
110.01	DI status	<i>PB</i>	0000h...FFFFh	-	1 = 1
110.02	DI delayed status	<i>PB</i>	0000h...FFFFh	-	1 = 1
110.03	DI force selection	<i>PB</i>	0000h...FFFFh	-	1 = 1
110.04	DI force data	<i>PB</i>	0000h...FFFFh	-	1 = 1
110.05	DI1 ON delay	<i>Real</i>	0.0 ... 3000.0	s	10 = 1 s
110.06	DI1 OFF delay	<i>Real</i>	0.0 ... 3000.0	s	10 = 1 s
110.07	DI2 ON delay	<i>Real</i>	0.0 ... 3000.0	s	10 = 1 s
110.08	DI2 OFF delay	<i>Real</i>	0.0 ... 3000.0	s	10 = 1 s
110.09	DI3 ON delay	<i>Real</i>	0.0 ... 3000.0	s	10 = 1 s
110.10	DI3 OFF delay	<i>Real</i>	0.0 ... 3000.0	s	10 = 1 s
110.11	DI4 ON delay	<i>Real</i>	0.0 ... 3000.0	s	10 = 1 s
110.12	DI4 OFF delay	<i>Real</i>	0.0 ... 3000.0	s	10 = 1 s
110.13	DI5 ON delay	<i>Real</i>	0.0 ... 3000.0	s	10 = 1 s
110.14	DI5 OFF delay	<i>Real</i>	0.0 ... 3000.0	s	10 = 1 s
110.15	DI6 ON delay	<i>Real</i>	0.0 ... 3000.0	s	10 = 1 s
110.16	DI6 OFF delay	<i>Real</i>	0.0 ... 3000.0	s	10 = 1 s
110.21	RO status	<i>PB</i>	0000h...FFFFh	-	1 = 1
110.24	RO1 source	<i>Binary src</i>	-	-	1 = 1
110.25	RO1 ON delay	<i>Real</i>	0.0 ... 3000.0	s	10 = 1 s
110.26	RO1 OFF delay	<i>Real</i>	0.0 ... 3000.0	s	10 = 1 s
110.27	RO2 source	<i>Binary src</i>	-	-	1 = 1
110.28	RO2 ON delay	<i>Real</i>	0.0 ... 3000.0	s	10 = 1 s
110.29	RO2 OFF delay	<i>Real</i>	0.0 ... 3000.0	s	10 = 1 s
110.30	RO3 source	<i>Binary src</i>	-	-	
110.31	RO3 ON delay	<i>Real</i>	0.0 ... 3000.0	s	10 = 1 s
110.32	RO3 OFF delay	<i>Real</i>	0.0 ... 3000.0	s	10 = 1 s
110.51	DI filter time	<i>Real</i>	0.3 ... 100.0	ms	10 = 1 ms
110.99	RO/DIO control word	<i>PB</i>	0000h...FFFFh	-	1 = 1
111 Standard DIO, FI, FO					
111.01	DIO status	<i>PB</i>	0000h...FFFFh	-	1 = 1
111.02	DIO delayed status	<i>PB</i>	0000h...FFFFh	-	1 = 1
111.05	DIO1 function	<i>List</i>	0...2	-	1 = 1
111.06	DIO1 output source	<i>Binary src</i>	-	-	1 = 1
111.07	DIO1 ON delay	<i>Real</i>	0.0 ... 3000.0	s	10 = 1 s
111.08	DIO1 OFF delay	<i>Real</i>	0.0 ... 3000.0	s	10 = 1 s
111.09	DIO2 function	<i>List</i>	0...2	-	1 = 1
111.10	DIO2 output source	<i>Binary src</i>	-	-	1 = 1
111.11	DIO2 ON delay	<i>Real</i>	0.0 ... 3000.0	s	10 = 1 s
111.12	DIO2 OFF delay	<i>Real</i>	0.0 ... 3000.0	s	10 = 1 s
111.38	Freq in 1 actual value	<i>Real</i>	0...16000	Hz	1 = 1 Hz
111.39	Freq in 1 scaled	<i>Real</i>	-32768.000 ... 32767.000	-	1000 = 1
111.42	Freq in 1 min	<i>Real</i>	0...16000	Hz	1 = 1 Hz
111.43	Freq in 1 max	<i>Real</i>	0...16000	Hz	1 = 1 Hz
111.44	Freq in 1 at scaled min	<i>Real</i>	-32768.000 ... 32767.000	-	1000 = 1
111.45	Freq in 1 at scaled max	<i>Real</i>	-32768.000 ... 32767.000	-	1000 = 1
111.81	DIO filter time	<i>Real</i>	0.3 ... 100.0	ms	10 = 1 ms

142 Additional parameter data

No.	Name	Type	Range	Unit	FbEq32
112 Standard AI					
112.03	AI supervision function	List	0...2	-	1 = 1
112.04	AI supervision selection	PB	0000h...FFFFh	-	1 = 1
112.11	AI1 actual value	Real	-22.000 ... 22.000 mA or -11.000 ... 11.000 V	mA or V	1000 = 1 mA
112.12	AI1 scaled value	Real	-32768.000 ... 32767.000	-	1000 = 1
112.15	AI1 unit selection	List	2...10	-	1 = 1
112.16	AI1 filter time	Real	0.000 ... 30.000	s	1000 = 1 s
112.17	AI1 min	Real	-22.000 ... 22.000 mA or -11.000 ... 11.000 V	mA or V	1000 = 1 V
112.18	AI1 max	Real	-22.000 ... 22.000 mA or -11.000 ... 11.000 V	mA or V	1000 = 1 V
112.19	AI1 scaled at AI1 min	Real	-32768.000 ... 32767.000	-	1000 = 1
112.20	AI1 scaled at AI1 max	Real	-32768.000 ... 32767.000	-	1000 = 1
112.21	AI2 actual value	Real	-22.000 ... 22.000 mA or -11.000 ... 11.000 V	mA or V	1000 = 1 mA
112.22	AI2 scaled value	Real	-32768.000 ... 32767.000	-	1000 = 1
112.25	AI2 unit selection	List	2...10	-	1 = 1
112.26	AI2 filter time	Real	0.000 ... 30.000	s	1000 = 1s
112.27	AI2 min	Real	-22.000 ... 22.000 mA or -11.000 ... 11.000 V	mA or V	1000 = 1 mA
112.28	AI2 max	Real	-22.000 ... 22.000 mA or -11.000 ... 11.000 V	mA or V	1000 = 1 mA
112.29	AI2 scaled at AI2 min	Real	-32768.000 ... 32767.000	-	1000 = 1
112.30	AI2 scaled at AI2 max	Real	-32768.000 ... 32767.000	-	1000 = 1
113 Standard AO					
113.11	AO1 actual value	Real	0.000 ... 22.000	mA	1000 = 1 mA
113.12	AO1 source	Analog src	-	-	1 = 1
113.16	AO1 filter time	Real	0.000 ... 30.000	s	1000 = 1 s
113.17	AO1 source min	Real	-32768.0 ... 32767.0	-	10 = 1
113.18	AO1 source max	Real	-32768.0 ... 32767.0	-	10 = 1
113.19	AO1 out at AO1 src min	Real	0.000 ... 22.000	mA	1000 = 1 mA
113.20	AO1 out at AO1 src max	Real	0.000 ... 22.000	mA	1000 = 1 mA
113.21	AO2 actual value	Real	0.000 ... 22.000	mA	1000 = 1 mA
113.22	AO2 source	Analog src	-	-	1 = 1
113.26	AO2 filter time	Real	0.000 ... 30.000	s	1000 = 1 s
113.27	AO2 source min	Real	-32768.0 ... 32767.0	-	10 = 1
113.28	AO2 source max	Real	-32768.0 ... 32767.0	-	10 = 1
113.29	AO2 out at AO2 src min	Real	0.000 ... 22.000	mA	1000 = 1 mA
113.30	AO2 out at AO2 src max	Real	0.000 ... 22.000	mA	1000 = 1 mA
113.91	AO1 data storage	Real	-327.68 ... 327.67	-	100 = 1
113.92	AO2 data storage	Real	-327.68 ... 327.67	-	100 = 1
114 Extension I/O module 1					
114.01	Module 1 type	List	0...4	-	1 = 1
114.02	Module 1 location	Real	1...254	-	1 = 1
114.03	Module 1 status	List	0...25	-	1 = 1
<i>Dlx (114.01 Module 1 type = FDIO-01)</i>					
114.05	DI status	PB	00000000h...FFFFFFFFh	-	1 = 1
114.06	DI delayed status	PB	00000000h...FFFFFFFFh	-	1 = 1
114.08	DI filter time	Real	0.8 ... 100.0	ms	10 = 1 ms

No.	Name	Type	Range	Unit	FbEq32
114.12	DI1 ON delay	<i>Real</i>	0.00 ... 3000.00	s	100 = 1 s
114.13	DI1 OFF delay	<i>Real</i>	0.00 ... 3000.00	s	100 = 1 s
114.17	DI2 ON delay	<i>Real</i>	0.00 ... 3000.00	s	100 = 1 s
114.18	DI2 OFF delay	<i>Real</i>	0.00 ... 3000.00	s	100 = 1 s
114.22	DI3 ON delay	<i>Real</i>	0.00 ... 3000.00	s	100 = 1 s
114.23	DI3 OFF delay	<i>Real</i>	0.00 ... 3000.00	s	100 = 1 s
<i>Common parameters for DIOx (114.01 Module 1 type = FIO-01 or FIO-11)</i>					
114.05	DIO status	<i>PB</i>	00000000h...FFFFFFFFh	-	1 = 1
114.06	DIO delayed status	<i>PB</i>	00000000h...FFFFFFFFh	-	1 = 1
<i>DIO1/DIO2 (114.01 Module 1 type = FIO-01 or FIO-11)</i>					
114.08	DIO filter time	<i>Real</i>	0.8 ... 100.0	ms	10 = 1 ms
114.09	DIO1 configuration	<i>List</i>	0...1	-	1 = 1
114.11	DIO1 output source	<i>Binary src</i>	-	-	1 = 1
114.12	DIO1 ON delay	<i>Real</i>	0.0 ... 3000.0	s	10 = 1 s
114.13	DIO1 OFF delay	<i>Real</i>	0.0 ... 3000.0	s	10 = 1 s
114.14	DIO2 configuration	<i>List</i>	0...1	-	1 = 1
114.16	DIO2 output source	<i>Binary src</i>	-	-	1 = 1
114.17	DIO2 ON delay	<i>Real</i>	0.0 ... 3000.0	s	10 = 1 s
114.18	DIO2 OFF delay	<i>Real</i>	0.0 ... 3000.0	s	10 = 1 s
<i>DIO3/DIO4 (114.01 Module 1 type = FIO-01)</i>					
114.19	DIO3 configuration	<i>List</i>	0...1	-	1 = 1
114.21	DIO3 output source	<i>Binary src</i>	-	-	1 = 1
114.22	DIO3 ON delay	<i>Real</i>	0.0 ... 3000.0	s	10 = 1 s
114.23	DIO3 OFF delay	<i>Real</i>	0.0 ... 3000.0	s	10 = 1 s
114.24	DIO4 configuration	<i>List</i>	0...1	-	1 = 1
114.26	DIO4 output source	<i>Binary src</i>	-	-	1 = 1
114.27	DIO4 ON delay	<i>Real</i>	0.0 ... 3000.0	s	10 = 1 s
114.28	DIO4 OFF delay	<i>Real</i>	0.0 ... 3000.0	s	10 = 1 s
<i>RO1/RO2 (114.01 Module 1 type = FIO-01 or FDIO-01)</i>					
114.31	RO status	<i>PB</i>	0000h...FFFFh	-	1 = 1
114.34	RO1 source	<i>Binary src</i>	-	-	1 = 1
114.35	RO1 ON delay	<i>Real</i>	0.0 ... 3000.0	s	10 = 1 s
114.36	RO1 OFF delay	<i>Real</i>	0.0 ... 3000.0	s	10 = 1 s
114.37	RO2 source	<i>Binary src</i>	-	-	1 = 1
114.38	RO2 ON delay	<i>Real</i>	0.0 ... 3000.0	s	10 = 1 s
114.39	RO2 OFF delay	<i>Real</i>	0.0 ... 3000.0	s	10 = 1 s
<i>Common parameters for AIx (114.01 Module 1 type = FIO-11 or FAIO-01)</i>					
114.19	AI supervision function	<i>List</i>	0...2	-	1 = 1
114.20	AI supervision selection	<i>PB</i>	0000h...FFFFh	-	1 = 1
114.22	AI force sel	<i>PB</i>	00000000h...FFFFFFFFh	-	1 = 1
<i>AI1/AI2 (114.01 Module 1 type = FIO-11 or FAIO-01)</i>					
114.26	AI1 actual value	<i>Real</i>	-22.000 ... 22.000	mA or V	1000 = 1 unit
114.27	AI1 scaled value	<i>Real</i>	-32768.000 ... 32767.000	-	1000 = 1
114.28	AI1 force data	<i>Real</i>	-22.000 ... 22.000	mA or V	1000 = 1 unit
114.29	AI1 HW switch pos	<i>List</i>	-	-	1 = 1
114.30	AI1 unit selection	<i>List</i>	-	-	1 = 1
114.31	AI1 filter gain	<i>List</i>	0...7	-	1 = 1
114.32	AI1 filter time	<i>Real</i>	0.000 ... 30.000	s	1000 = 1 s

144 Additional parameter data

No.	Name	Type	Range	Unit	FbEq32
114.33	AI1 min	<i>Real</i>	-22.000 ... 22.000	mA or V	1000 = 1 mA or V
114.34	AI1 max	<i>Real</i>	-22.000 ... 22.000	mA or V	1000 = 1 mA or V
114.35	AI1 scaled at AI1 min	<i>Real</i>	-32768.000 ... 32767.000	-	1000 = 1
114.36	AI1 scaled at AI1 max	<i>Real</i>	-32768.000 ... 32767.000	-	1000 = 1
114.41	AI2 actual value	<i>Real</i>	-22.000 ... 22.000	mA or V	1000 = 1 unit
114.42	AI2 scaled value	<i>Real</i>	-32768.000 ... 32767.000	-	1000 = 1
114.43	AI2 force data	<i>Real</i>	-22.000 ... 22.000	mA or V	1000 = 1 unit
114.44	AI2 HW switch pos	<i>List</i>	-	-	1 = 1
114.45	AI2 unit selection	<i>List</i>	-	-	1 = 1
114.46	AI2 filter gain	<i>List</i>	0...7	-	1 = 1
114.47	AI2 filter time	<i>Real</i>	0.000 ... 30.000	s	1000 = 1 s
114.48	AI2 min	<i>Real</i>	-22.000 ... 22.000	mA or V	1000 = 1 mA or V
114.49	AI2 max	<i>Real</i>	-22.000 ... 22.000	mA or V	1000 = 1 mA or V
114.50	AI2 scaled at AI2 min	<i>Real</i>	-32768.000 ... 32767.000	-	1000 = 1
114.51	AI2 scaled at AI2 max	<i>Real</i>	-32768.000 ... 32767.000	-	1000 = 1
<i>AI3 (114.01 Module 1 type = FIO-11)</i>					
114.56	AI3 actual value	<i>Real</i>	-22.000 ... 22.000	mA or V	1000 = 1 unit
114.57	AI3 scaled value	<i>Real</i>	-32768.000 ... 32767.000	-	1000 = 1
114.58	AI3 force data	<i>Real</i>	-22.000 ... 22.000	mA or V	1000 = 1 unit
114.59	AI3 HW switch pos	<i>List</i>	-	-	1 = 1
114.60	AI3 unit selection	<i>List</i>	-	-	1 = 1
114.61	AI3 filter gain	<i>List</i>	0...7	-	1 = 1
114.62	AI3 filter time	<i>Real</i>	0.000 ... 30.000	s	1000 = 1 s
114.63	AI3 min	<i>Real</i>	-22.000 ... 22.000	mA or V	1000 = 1 mA or V
114.64	AI3 max	<i>Real</i>	-22.000 ... 22.000	mA or V	1000 = 1 mA or V
114.65	AI3 scaled at AI3 min	<i>Real</i>	-32768.000 ... 32767.000	-	1000 = 1
114.66	AI3 scaled at AI3 max	<i>Real</i>	-32768.000 ... 32767.000	-	1000 = 1
<i>Common parameters for AOx (114.01 Module 1 type = FIO-11 or FAIO-01)</i>					
114.71	AO force selection	<i>PB</i>	00000000h...FFFFFFFFh	-	1 = 1
<i>AO1 (114.01 Module 1 type = FIO-11 or FAIO-01)</i>					
114.76	AO1 actual value	<i>Real</i>	0.000 ... 22.000	mA	1000 = 1 mA
114.77	AO1 source	<i>Analog src</i>	-	-	1 = 1
114.78	AO1 force data	<i>Real</i>	0.000 ... 22.000	mA	1000 = 1 mA
114.79	AO1 filter time	<i>Real</i>	0.000 ... 30.000	s	1000 = 1 s
114.80	AO1 source min	<i>Real</i>	-32768.0 ... 32767.0	-	10 = 1
114.81	AO1 source max	<i>Real</i>	-32768.0 ... 32767.0	-	10 = 1
114.82	AO1 out at AO1 src min	<i>Real</i>	0.000 ... 22.000	mA	1000 = 1 mA
114.83	AO1 out at AO1 src max	<i>Real</i>	0.000 ... 22.000	mA	1000 = 1 mA
<i>AO2 (114.01 Module 1 type = FAIO-01)</i>					
114.86	AO2 actual value	<i>Real</i>	0.000 ... 22.000	mA	1000 = 1 mA
114.87	AO2 source	<i>Analog src</i>	-	-	1 = 1
114.88	AO2 force data	<i>Real</i>	0.000 ... 22.000	mA	1000 = 1 mA
114.89	AO2 filter time	<i>Real</i>	0.000 ... 30.000	s	1000 = 1 s
114.90	AO2 source min	<i>Real</i>	-32768.0 ... 32767.0	-	10 = 1

No.	Name	Type	Range	Unit	FbEq32
114.91	AO2 source max	<i>Real</i>	-32768.0 ... 32767.0	-	10 = 1
114.92	AO2 out at AO2 src min	<i>Real</i>	0.000 ... 22.000	mA	1000 = 1 mA
114.93	AO2 out at AO2 src max	<i>Real</i>	0.000 ... 22.000	mA	1000 = 1 mA
115 Extension I/O module 2					
115.01	Module 2 type	<i>List</i>	0...4	-	1 = 1
115.02	Module 2 location	<i>Real</i>	1...254	-	1 = 1
115.03	Module 2 status	<i>List</i>	0...25	-	1 = 1
<i>Dlx (115.01 Module 2 type = FDIO-01)</i>					
115.05	DI status	<i>PB</i>	00000000h...FFFFFFFFh	-	1 = 1
115.06	DI delayed status	<i>PB</i>	00000000h...FFFFFFFFh	-	1 = 1
115.08	DI filter time	<i>Real</i>	0.8 ... 100.0	ms	10 = 1 ms
115.12	DI1 ON delay	<i>Real</i>	0.00 ... 3000.00	s	100 = 1 s
115.13	DI1 OFF delay	<i>Real</i>	0.00 ... 3000.00	s	100 = 1 s
115.17	DI2 ON delay	<i>Real</i>	0.00 ... 3000.00	s	100 = 1 s
115.18	DI2 OFF delay	<i>Real</i>	0.00 ... 3000.00	s	100 = 1 s
115.22	DI3 ON delay	<i>Real</i>	0.00 ... 3000.00	s	100 = 1 s
115.23	DI3 OFF delay	<i>Real</i>	0.00 ... 3000.00	s	100 = 1 s
<i>Common parameters for DIOx (115.01 Module 2 type = FIO-01 or FIO-11)</i>					
115.05	DIO status	<i>PB</i>	00000000h...FFFFFFFFh	-	1 = 1
115.06	DIO delayed status	<i>PB</i>	00000000h...FFFFFFFFh	-	1 = 1
<i>DIO1/DIO2 (115.01 Module 2 type = FIO-01 or FIO-11)</i>					
115.08	DIO filter time	<i>Real</i>	0.8 ... 100.0	ms	10 = 1 ms
115.09	DIO1 configuration	<i>List</i>	0...1	-	1 = 1
115.11	DIO1 output source	<i>Binary src</i>	-	-	1 = 1
115.12	DIO1 ON delay	<i>Real</i>	0.0 ... 3000.0	s	10 = 1 s
115.13	DIO1 OFF delay	<i>Real</i>	0.0 ... 3000.0	s	10 = 1 s
115.14	DIO2 configuration	<i>List</i>	0...1	-	1 = 1
115.16	DIO2 output source	<i>Binary src</i>	-	-	1 = 1
115.17	DIO2 ON delay	<i>Real</i>	0.0 ... 3000.0	s	10 = 1 s
115.18	DIO2 OFF delay	<i>Real</i>	0.0 ... 3000.0	s	10 = 1 s
<i>DIO3/DIO4 (115.01 Module 2 type = FIO-01)</i>					
115.19	DIO3 configuration	<i>List</i>	0...1	-	1 = 1
115.21	DIO3 output source	<i>Binary src</i>	-	-	1 = 1
115.22	DIO3 ON delay	<i>Real</i>	0.0 ... 3000.0	s	10 = 1 s
115.23	DIO3 OFF delay	<i>Real</i>	0.0 ... 3000.0	s	10 = 1 s
115.24	DIO4 configuration	<i>List</i>	0...1	-	1 = 1
115.26	DIO4 output source	<i>Binary src</i>	-	-	1 = 1
115.27	DIO4 ON delay	<i>Real</i>	0.0 ... 3000.0	s	10 = 1 s
115.28	DIO4 OFF delay	<i>Real</i>	0.0 ... 3000.0	s	10 = 1 s
<i>RO1/RO2 (115.01 Module 2 type = FIO-01 or FDIO-01)</i>					
115.31	RO status	<i>PB</i>	0000h...FFFFh	-	1 = 1
115.34	RO1 source	<i>Binary src</i>	-	-	1 = 1
115.35	RO1 ON delay	<i>Real</i>	0.0 ... 3000.0	s	10 = 1 s
115.36	RO1 OFF delay	<i>Real</i>	0.0 ... 3000.0	s	10 = 1 s
115.37	RO2 source	<i>Binary src</i>	-	-	1 = 1
115.38	RO2 ON delay	<i>Real</i>	0.0 ... 3000.0	s	10 = 1 s
115.39	RO2 OFF delay	<i>Real</i>	0.0 ... 3000.0	s	10 = 1 s
<i>Common parameters for AIx (115.01 Module 2 type = FIO-11 or FAIO-01)</i>					
115.19	AI supervision function	<i>List</i>	0...2	-	1 = 1

No.	Name	Type	Range	Unit	FbEq32
115.20	AI supervision selection	<i>PB</i>	0000h...FFFFh	-	1 = 1
115.22	AI force sel	<i>PB</i>	00000000h...FFFFFFFFh	-	1 = 1
<i>AI1/AI2 (115.01 Module 2 type = FIO-11 or FAIO-01)</i>					
115.26	AI1 actual value	<i>Real</i>	-22.000 ... 22.000	mA or V	1000 = 1 unit
115.27	AI1 scaled value	<i>Real</i>	-32768.000 ... 32767.000	-	1000 = 1
115.28	AI1 force data	<i>Real</i>	-22.000 ... 22.000	mA or V	1000 = 1 unit
115.29	AI1 HW switch pos	<i>List</i>	-	-	1 = 1
115.30	AI1 unit selection	<i>List</i>	-	-	1 = 1
115.31	AI1 filter gain	<i>List</i>	0...7	-	1 = 1
115.32	AI1 filter time	<i>Real</i>	0.000 ... 30.000	s	1000 = 1 s
115.33	AI1 min	<i>Real</i>	-22.000 ... 22.000	mA or V	1000 = 1 mA or V
115.34	AI1 max	<i>Real</i>	-22.000 ... 22.000	mA or V	1000 = 1 mA or V
115.35	AI1 scaled at AI1 min	<i>Real</i>	-32768.000 ... 32767.000	-	1000 = 1
115.36	AI1 scaled at AI1 max	<i>Real</i>	-32768.000 ... 32767.000	-	1000 = 1
115.41	AI2 actual value	<i>Real</i>	-22.000 ... 22.000	mA or V	1000 = 1 unit
115.42	AI2 scaled value	<i>Real</i>	-32768.000 ... 32767.000	-	1000 = 1
115.43	AI2 force data	<i>Real</i>	-22.000 ... 22.000	mA or V	1000 = 1 unit
115.44	AI2 HW switch pos	<i>List</i>	-	-	1 = 1
115.45	AI2 unit selection	<i>List</i>	-	-	1 = 1
115.46	AI2 filter gain	<i>List</i>	0...7	-	1 = 1
115.47	AI2 filter time	<i>Real</i>	0.000 ... 30.000	s	1000 = 1 s
115.48	AI2 min	<i>Real</i>	-22.000 ... 22.000	mA or V	1000 = 1 mA or V
115.49	AI2 max	<i>Real</i>	-22.000 ... 22.000	mA or V	1000 = 1 mA or V
115.50	AI2 scaled at AI2 min	<i>Real</i>	-32768.000 ... 32767.000	-	1000 = 1
115.51	AI2 scaled at AI2 max	<i>Real</i>	-32768.000 ... 32767.000	-	1000 = 1
<i>AI3 (115.01 Module 2 type = FIO-11)</i>					
115.56	AI3 actual value	<i>Real</i>	-22.000 ... 22.000	mA or V	1000 = 1 unit
115.57	AI3 scaled value	<i>Real</i>	-32768.000 ... 32767.000	-	1000 = 1
115.58	AI3 force data	<i>Real</i>	-22.000 ... 22.000	mA or V	1000 = 1 unit
115.59	AI3 HW switch pos	<i>List</i>	-	-	1 = 1
115.60	AI3 unit selection	<i>List</i>	-	-	1 = 1
115.61	AI3 filter gain	<i>List</i>	0...7	-	1 = 1
115.62	AI3 filter time	<i>Real</i>	0.000 ... 30.000	s	1000 = 1 s
115.63	AI3 min	<i>Real</i>	-22.000 ... 22.000	mA or V	1000 = 1 mA or V
115.64	AI3 max	<i>Real</i>	-22.000 ... 22.000	mA or V	1000 = 1 mA or V
115.65	AI3 scaled at AI3 min	<i>Real</i>	-32768.000 ... 32767.000	-	1000 = 1
115.66	AI3 scaled at AI3 max	<i>Real</i>	-32768.000 ... 32767.000	-	1000 = 1
<i>Common parameters for AOx (115.01 Module 2 type = FIO-11 or FAIO-01)</i>					
115.71	AO force selection	<i>PB</i>	00000000h...FFFFFFFFh	-	1 = 1
<i>AO1 (115.01 Module 2 type = FIO-11 or FAIO-01)</i>					
115.76	AO1 actual value	<i>Real</i>	0.000 ... 22.000	mA	1000 = 1 mA
115.77	AO1 source	<i>Analog src</i>	-	-	1 = 1
115.78	AO1 force data	<i>Real</i>	0.000 ... 22.000	mA	1000 = 1 mA
115.79	AO1 filter time	<i>Real</i>	0.000 ... 30.000	s	1000 = 1 s

No.	Name	Type	Range	Unit	FbEq32
115.80	AO1 source min	<i>Real</i>	-32768.0 ... 32767.0	-	10 = 1
115.81	AO1 source max	<i>Real</i>	-32768.0 ... 32767.0	-	10 = 1
115.82	AO1 out at AO1 src min	<i>Real</i>	0.000 ... 22.000	mA	1000 = 1 mA
115.83	AO1 out at AO1 src max	<i>Real</i>	0.000 ... 22.000	mA	1000 = 1 mA
<i>AO2 (115.01 Module 2 type = FAIO-01)</i>					
115.86	AO2 actual value	<i>Real</i>	0.000 ... 22.000	mA	1000 = 1 mA
115.87	AO2 source	<i>Analog src</i>	-	-	1 = 1
115.88	AO2 force data	<i>Real</i>	0.000 ... 22.000	mA	1000 = 1 mA
115.89	AO2 filter time	<i>Real</i>	0.000 ... 30.000	s	1000 = 1 s
115.90	AO2 source min	<i>Real</i>	-32768.0 ... 32767.0	-	10 = 1
115.91	AO2 source max	<i>Real</i>	-32768.0 ... 32767.0	-	10 = 1
115.92	AO2 out at AO2 src min	<i>Real</i>	0.000 ... 22.000	mA	1000 = 1 mA
115.93	AO2 out at AO2 src max	<i>Real</i>	0.000 ... 22.000	mA	1000 = 1 mA
116 Extension I/O module 3					
116.01	Module 3 type	<i>List</i>	0...4	-	1 = 1
116.02	Module 3 location	<i>Real</i>	1...254	-	1 = 1
116.03	Module 3 status	<i>List</i>	0...25	-	1 = 1
<i>Dlx (116.01 Module 3 type = FDIO-01)</i>					
116.05	DI status	<i>PB</i>	00000000h...FFFFFFFFh	-	1 = 1
116.06	DI delayed status	<i>PB</i>	00000000h...FFFFFFFFh	-	1 = 1
116.08	DI filter time	<i>Real</i>	0.8 ... 100.0	ms	10 = 1 ms
116.12	DI1 ON delay	<i>Real</i>	0.00 ... 3000.00	s	100 = 1 s
116.13	DI1 OFF delay	<i>Real</i>	0.00 ... 3000.00	s	100 = 1 s
116.17	DI2 ON delay	<i>Real</i>	0.00 ... 3000.00	s	100 = 1 s
116.18	DI2 OFF delay	<i>Real</i>	0.00 ... 3000.00	s	100 = 1 s
116.22	DI3 ON delay	<i>Real</i>	0.00 ... 3000.00	s	100 = 1 s
116.23	DI3 OFF delay	<i>Real</i>	0.00 ... 3000.00	s	100 = 1 s
<i>Common parameters for DIOx (116.01 Module 3 type = FIO-01 or FIO-11)</i>					
116.05	DIO status	<i>PB</i>	00000000h...FFFFFFFFh	-	1 = 1
116.06	DIO delayed status	<i>PB</i>	00000000h...FFFFFFFFh	-	1 = 1
<i>DIO1/DIO2 (116.01 Module 3 type = FIO-01 or FIO-11)</i>					
116.08	DIO filter time	<i>Real</i>	0.8 ... 100.0	ms	10 = 1 ms
116.09	DIO1 configuration	<i>List</i>	0...1	-	1 = 1
116.11	DIO1 output source	<i>Binary src</i>	-	-	1 = 1
116.12	DIO1 ON delay	<i>Real</i>	0.0 ... 3000.0	s	10 = 1 s
116.13	DIO1 OFF delay	<i>Real</i>	0.0 ... 3000.0	s	10 = 1 s
116.14	DIO2 configuration	<i>List</i>	0...1	-	1 = 1
116.16	DIO2 output source	<i>Binary src</i>	-	-	1 = 1
116.17	DIO2 ON delay	<i>Real</i>	0.0 ... 3000.0	s	10 = 1 s
116.18	DIO2 OFF delay	<i>Real</i>	0.0 ... 3000.0	s	10 = 1 s
<i>DIO3/DIO4 (116.01 Module 3 type = FIO-01)</i>					
116.19	DIO3 configuration	<i>List</i>	0...1	-	1 = 1
116.21	DIO3 output source	<i>Binary src</i>	-	-	1 = 1
116.22	DIO3 ON delay	<i>Real</i>	0.0 ... 3000.0	s	10 = 1 s
116.23	DIO3 OFF delay	<i>Real</i>	0.0 ... 3000.0	s	10 = 1 s
116.24	DIO4 configuration	<i>List</i>	0...1	-	1 = 1
116.26	DIO4 output source	<i>Binary src</i>	-	-	1 = 1
116.27	DIO4 ON delay	<i>Real</i>	0.0 ... 3000.0	s	10 = 1 s
116.28	DIO4 OFF delay	<i>Real</i>	0.0 ... 3000.0	s	10 = 1 s

148 Additional parameter data

No.	Name	Type	Range	Unit	FbEq32
<i>RO1/RO2 (116.01 Module 3 type = FIO-01 or FDIO-01)</i>					
116.31	RO status	<i>PB</i>	0000h...FFFFh	-	1 = 1
116.34	RO1 source	<i>Binary src</i>	-	-	1 = 1
116.35	RO1 ON delay	<i>Real</i>	0.0 ... 3000.0	s	10 = 1 s
116.36	RO1 OFF delay	<i>Real</i>	0.0 ... 3000.0	s	10 = 1 s
116.37	RO2 source	<i>Binary src</i>	-	-	1 = 1
116.38	RO2 ON delay	<i>Real</i>	0.0 ... 3000.0	s	10 = 1 s
116.39	RO2 OFF delay	<i>Real</i>	0.0 ... 3000.0	s	10 = 1 s
<i>Common parameters for Alx (116.01 Module 3 type = FIO-11 or FAIO-01)</i>					
116.19	AI supervision function	<i>List</i>	0...2	-	1 = 1
116.20	AI supervision selection	<i>PB</i>	0000h...FFFFh	-	1 = 1
116.22	AI force sel	<i>PB</i>	00000000h...FFFFFFFh	-	1 = 1
<i>AI1/AI2 (116.01 Module 3 type = FIO-11 or FAIO-01)</i>					
116.26	AI1 actual value	<i>Real</i>	-22.000 ... 22.000	mA or V	1000 = 1 unit
116.27	AI1 scaled value	<i>Real</i>	-32768.000 ... 32767.000	-	1000 = 1
116.28	AI1 force data	<i>Real</i>	-22.000 ... 22.000	mA or V	1000 = 1 unit
116.29	AI1 HW switch pos	<i>List</i>	-	-	1 = 1
116.30	AI1 unit selection	<i>List</i>	-	-	1 = 1
116.31	AI1 filter gain	<i>List</i>	0...7	-	1 = 1
116.32	AI1 filter time	<i>Real</i>	0.000 ... 30.000	s	1000 = 1 s
116.33	AI1 min	<i>Real</i>	-22.000 ... 22.000	mA or V	1000 = 1 mA or V
116.34	AI1 max	<i>Real</i>	-22.000 ... 22.000	mA or V	1000 = 1 mA or V
116.35	AI1 scaled at AI1 min	<i>Real</i>	-32768.000 ... 32767.000	-	1000 = 1
116.36	AI1 scaled at AI1 max	<i>Real</i>	-32768.000 ... 32767.000	-	1000 = 1
116.41	AI2 actual value	<i>Real</i>	-22.000 ... 22.000	mA or V	1000 = 1 unit
116.42	AI2 scaled value	<i>Real</i>	-32768.000 ... 32767.000	-	1000 = 1
116.43	AI2 force data	<i>Real</i>	-22.000 ... 22.000	mA or V	1000 = 1 unit
116.44	AI2 HW switch pos	<i>List</i>	-	-	1 = 1
116.45	AI2 unit selection	<i>List</i>	-	-	1 = 1
116.46	AI2 filter gain	<i>List</i>	0...7	-	1 = 1
116.47	AI2 filter time	<i>Real</i>	0.000 ... 30.000	s	1000 = 1 s
116.48	AI2 min	<i>Real</i>	-22.000 ... 22.000	mA or V	1000 = 1 mA or V
116.49	AI2 max	<i>Real</i>	-22.000 ... 22.000	mA or V	1000 = 1 mA or V
116.50	AI2 scaled at AI2 min	<i>Real</i>	-32768.000 ... 32767.000	-	1000 = 1
116.51	AI2 scaled at AI2 max	<i>Real</i>	-32768.000 ... 32767.000	-	1000 = 1
<i>AI3 (116.01 Module 3 type = FIO-11)</i>					
116.56	AI3 actual value	<i>Real</i>	-22.000 ... 22.000	mA or V	1000 = 1 unit
116.57	AI3 scaled value	<i>Real</i>	-32768.000 ... 32767.000	-	1000 = 1
116.58	AI3 force data	<i>Real</i>	-22.000 ... 22.000	mA or V	1000 = 1 unit
116.59	AI3 HW switch pos	<i>List</i>	-	-	1 = 1
116.60	AI3 unit selection	<i>List</i>	-	-	1 = 1
116.61	AI3 filter gain	<i>List</i>	0...7	-	1 = 1
116.62	AI3 filter time	<i>Real</i>	0.000 ... 30.000	s	1000 = 1 s
116.63	AI3 min	<i>Real</i>	-22.000 ... 22.000	mA or V	1000 = 1 mA or V

No.	Name	Type	Range	Unit	FbEq32
116.64	AI3 max	<i>Real</i>	-22.000 ... 22.000	mA or V	1000 = 1 mA or V
116.65	AI3 scaled at AI3 min	<i>Real</i>	-32768.000 ... 32767.000	-	1000 = 1
116.66	AI3 scaled at AI3 max	<i>Real</i>	-32768.000 ... 32767.000	-	1000 = 1
<i>Common parameters for AOx (116.01 Module 3 type = FIO-11 or FAIO-01)</i>					
116.71	AO force selection	<i>PB</i>	00000000h...FFFFFFFFh	-	1 = 1
<i>AO1 (116.01 Module 3 type = FIO-11 or FAIO-01)</i>					
116.76	AO1 actual value	<i>Real</i>	0.000 ... 22.000	mA	1000 = 1 mA
116.77	AO1 source	<i>Analog src</i>	-	-	1 = 1
116.78	AO1 force data	<i>Real</i>	0.000 ... 22.000	mA	1000 = 1 mA
116.79	AO1 filter time	<i>Real</i>	0.000 ... 30.000	s	1000 = 1 s
116.80	AO1 source min	<i>Real</i>	-32768.0 ... 32767.0	-	10 = 1
116.81	AO1 source max	<i>Real</i>	-32768.0 ... 32767.0	-	10 = 1
116.82	AO1 out at AO1 src min	<i>Real</i>	0.000 ... 22.000	mA	1000 = 1 mA
116.83	AO1 out at AO1 src max	<i>Real</i>	0.000 ... 22.000	mA	1000 = 1 mA
<i>AO2 (116.01 Module 3 type = FAIO-01)</i>					
116.86	AO2 actual value	<i>Real</i>	0.000 ... 22.000	mA	1000 = 1 mA
116.87	AO2 source	<i>Analog src</i>	-	-	1 = 1
116.88	AO2 force data	<i>Real</i>	0.000 ... 22.000	mA	1000 = 1 mA
116.89	AO2 filter time	<i>Real</i>	0.000 ... 30.000	s	1000 = 1 s
116.90	AO2 source min	<i>Real</i>	-32768.0 ... 32767.0	-	10 = 1
116.91	AO2 source max	<i>Real</i>	-32768.0 ... 32767.0	-	10 = 1
116.92	AO2 out at AO2 src min	<i>Real</i>	0.000 ... 22.000	mA	1000 = 1 mA
116.93	AO2 out at AO2 src max	<i>Real</i>	0.000 ... 22.000	mA	1000 = 1 mA
119 Operation mode					
119.11	Ext1/Ext2 sel	<i>Binary src</i>	-	-	1 = 1
119.17	Local ctrl disable	<i>List</i>	0...1	-	1 = 1
120 Start/stop					
120.01	Ext1 commands	<i>List</i>	0...16	-	1 = 1
120.02	Ext1 start trigger	<i>List</i>	0...1	-	1 = 1
120.03	Ext1 in1	<i>Binary src</i>	-	-	1 = 1
120.04	Ext1 in2	<i>Binary src</i>	-	-	1 = 1
120.06	Ext2 commands	<i>List</i>	0...16	-	1 = 1
120.07	Ext2 start trigger	<i>List</i>	0...1	-	1 = 1
120.08	Ext2 in1	<i>Binary src</i>	-	-	1 = 1
120.09	Ext2 in2	<i>Binary src</i>	-	-	1 = 1
120.12	Run enable 1	<i>Binary src</i>	-	-	1 = 1
120.19	Enable start signal	<i>Binary src</i>	-	-	1 = 1
120.21	Delay for MCB DI3 supervision	<i>Real</i>	0.00...8.00	s	100 = 1 s
120.23	Max DC charging time	<i>Real</i>	0.00 ... 10.00	s	100 = 1 s
120.25	MCB closing level	<i>Real</i>	20...100	%	1 = 1%
120.26	Maximum dU/dt	<i>Real</i>	0 ... 200	V/s	1 = 1 V/s
120.27	Start delay	<i>Real</i>	0.00 ... 10.00	s	100 = 1 s
120.28	MCB relay timing	<i>Real</i>	-6.00 ... 6.00	s	100 = 1 s
120.30	External charge enable	<i>List</i>	0...1	-	1 = 1
120.50	Charging overload event sel	<i>List</i>	0...2	-	1 = 1
120.60	DC voltage external unscaled	<i>Real</i>	0.00...65535.00	-	100 = 1
120.61	External DC voltage scale	<i>Real</i>	-100.00...100.00	-	100 = 1

No.	Name	Type	Range	Unit	FbEq32
121 Start/stop mode					
121.04	Emergency stop mode	List	0...2	-	1 = 1
121.05	Emergency stop source	Binary src	-	-	1 = 1
131 Fault functions					
131.01	External event 1 source	Binary src	-	-	1 = 1
131.02	External event 1 type	List	0...3	-	1 = 1
131.03	External event 2 source	Binary src	-	-	1 = 1
131.04	External event 2 type	List	0...3	-	1 = 1
131.05	External event 3 source	Binary src	-	-	1 = 1
131.06	External event 3 type	List	0...3	-	1 = 1
131.07	External event 4 source	Binary src	-	-	1 = 1
131.08	External event 4 type	List	0...3	-	1 = 1
131.09	External event 5 source	Binary src	-	-	1 = 1
131.10	External event 5 type	List	0...3	-	1 = 1
131.11	Fault reset selection	Binary src	-	-	1 = 1
131.12	Autoreset selection	PB	0000h...FFFFh	-	1 = 1
131.13	User selectable fault	PB	0000h...FFFFh	-	1 = 1
131.14	Number of trials	Real	0...5	-	1 = 1
131.15	Total trials time	Real	1.0 ... 600.0	s	10 = 1 s
131.16	Delay time	Real	0.0 ... 120.0	s	10 = 1 s
131.28	Ext earth leakage signal source	Binary src	-	-	1 = 1
131.29	Ext earth leakage action	List	0...1	-	1 = 1
131.32	Aux circuit breaker fault source	Binary src	-	-	1 = 1
131.33	Cabinet temperature fault source	Binary src	-	-	1 = 1
131.34	Cabinet temperature supervision	List	0...1	-	1 = 1
131.35	Main fan fault function	List	0...2	-	1 = 1
131.38	Fuse trip fault source	Binary src	-	-	1 = 1
131.39	Brake chopper fault source	Binary src	-	-	1 = 1
131.40	Disable warning messages	PB	0000h...FFFFh	-	1 = 1
133 Generic timer & counter					
133.01	Counter status	PB	0000h...FFFFh	-	1 = 1
133.10	On-time 1 act	Real	0...4294967295	s	1 = 1
133.11	On-time 1 limit	Real	0...4294967295	s	1 = 1
133.12	On-time 1 func	PB	0000h...FFFFh	-	1 = 1
133.13	On-time 1 src	Binary src	-	-	1 = 1
133.14	On-time 1 warn sel	List	-	-	1 = 1
133.20	On-time 2 act	Real	0...4294967295	s	1 = 1
133.21	On-time 2 limit	Real	0...4294967295	s	1 = 1
133.22	On-time 2 func	PB	0000h...FFFFh	-	1 = 1
133.23	On-time 2 src	Binary src	-	-	1 = 1
133.24	On-time 2 warn sel	List	-	-	1 = 1
133.30	Edge count 1 act	Real	0...4294967295	-	1 = 1
133.31	Edge count 1 limit	Real	0...4294967295	-	1 = 1
133.32	Edge count 1 func	PB	0000h...FFFFh	-	1 = 1
133.33	Edge count 1 src	Binary src	-	-	1 = 1

No.	Name	Type	Range	Unit	FbEq32
133.34	Edge count 1 div	<i>Real</i>	1...4294967295	-	1 = 1
133.35	Edge count 1 warn sel	<i>List</i>	-	-	1 = 1
133.40	Edge count 2 act	<i>Real</i>	0...4294967295	-	1 = 1
133.41	Edge count 2 limit	<i>Real</i>	0...4294967295	-	1 = 1
133.42	Edge count 2 func	<i>PB</i>	0000h...FFFFh	-	1 = 1
133.43	Edge count 2 src	<i>Binary src</i>	-	-	1 = 1
133.44	Edge count 2 div	<i>Real</i>	1...4294967295	-	1 = 1
133.45	Edge count 2 warn sel	<i>List</i>	-	-	1 = 1
133.50	Value count 1 act	<i>Real</i>	-2147483008 ... 2147483008	-	1 = 1
133.51	Value count 1 limit	<i>Real</i>	-2147483008 ... 2147483008	-	1 = 1
133.52	Value count 1 func	<i>PB</i>	0000h...FFFFh	-	1 = 1
133.53	Value count 1 src	<i>Analog src</i>	-	-	1 = 1
133.54	Value count 1 div	<i>Real</i>	0.001 ... 2147483.000	-	1000 = 1
133.55	Value count 1 warn sel	<i>List</i>	-	-	1 = 1
133.60	Value count 2 act	<i>Real</i>	-2147483008 ... 2147483008	-	1 = 1
133.61	Value count 2 limit	<i>Real</i>	-2147483008 ... 2147483008	-	1 = 1
133.62	Value count 2 func	<i>PB</i>	0000h...FFFFh	-	1 = 1
133.63	Value count 2 src	<i>Analog src</i>	-	-	1 = 1
133.64	Value count 2 div	<i>Real</i>	0.001 ... 2147483.000	-	1000 = 1
133.65	Value count 2 warn sel	<i>List</i>	-	-	1 = 1
136 Load analyzer					
136.01	PVL signal source	<i>Analog src</i>	-	-	1 = 1
136.02	PVL filter time	<i>Real</i>	0.00 ... 120.00	s	100 = 1 s
136.06	AL2 signal source	<i>Analog src</i>	-	-	1 = 1
136.07	AL2 signal scaling	<i>Real</i>	0.00 ... 32767.00	-	100 = 1
136.09	Reset loggers	<i>List</i>	0...3	-	1 = 1
136.10	PVL peak value	<i>Real</i>	-32768.00 ... 32767.00	-	100 = 1
136.11	PVL peak date	<i>Data</i>	-	-	1 = 1
136.12	PVL peak time	<i>Data</i>	-	-	1 = 1
136.13	PVL current at peak	<i>Real</i>	-32768.00 ... 32767.00	A	100 = 1 A
136.14	PVL DC voltage at peak	<i>Real</i>	0.00 ... 2000.00	V	100 = 1 V
136.15	PVL power at peak	<i>Real</i>	-32768.0...32767.0	kW	10 = 1 kW
136.16	PVL reset date	<i>Data</i>	-	-	1 = 1
136.17	PVL reset time	<i>Data</i>	-	-	1 = 1
136.20	AL1 below 10%	<i>Real</i>	0.00 ... 100.00	%	100 = 1%
136.21	AL1 10 to 20%	<i>Real</i>	0.00 ... 100.00	%	100 = 1%
136.22	AL1 20 to 30%	<i>Real</i>	0.00 ... 100.00	%	100 = 1%
136.23	AL1 30 to 40%	<i>Real</i>	0.00 ... 100.00	%	100 = 1%
136.24	AL1 40 to 50%	<i>Real</i>	0.00 ... 100.00	%	100 = 1%
136.25	AL1 50 to 60%	<i>Real</i>	0.00 ... 100.00	%	100 = 1%
136.26	AL1 60 to 70%	<i>Real</i>	0.00 ... 100.00	%	100 = 1%
136.27	AL1 70 to 80%	<i>Real</i>	0.00 ... 100.00	%	100 = 1%
136.28	AL1 80 to 90%	<i>Real</i>	0.00 ... 100.00	%	100 = 1%
136.29	AL1 over 90%	<i>Real</i>	0.00 ... 100.00	%	100 = 1%
136.40	AL2 below 10%	<i>Real</i>	0.00 ... 100.00	%	100 = 1%
136.41	AL2 10 to 20%	<i>Real</i>	0.00 ... 100.00	%	100 = 1%
136.42	AL2 20 to 30%	<i>Real</i>	0.00 ... 100.00	%	100 = 1%
136.43	AL2 30 to 40%	<i>Real</i>	0.00 ... 100.00	%	100 = 1%
136.44	AL2 40 to 50%	<i>Real</i>	0.00 ... 100.00	%	100 = 1%

152 Additional parameter data

No.	Name	Type	Range	Unit	FbEq32
136.45	AL2 50 to 60%	<i>Real</i>	0.00 ... 100.00	%	100 = 1%
136.46	AL2 60 to 70%	<i>Real</i>	0.00 ... 100.00	%	100 = 1%
136.47	AL2 70 to 80%	<i>Real</i>	0.00 ... 100.00	%	100 = 1%
136.48	AL2 80 to 90%	<i>Real</i>	0.00 ... 100.00	%	100 = 1%
136.49	AL2 over 90%	<i>Real</i>	0.00 ... 100.00	%	100 = 1%
136.50	AL2 reset date	<i>Data</i>	-	-	1 = 1
136.51	AL2 reset time	<i>Data</i>	-	-	1 = 1
147 Data storage					
147.01	Data storage 1 real32	<i>Real</i>	-32768.000...32767.000	-	1000 = 1
147.02	Data storage 2 real32	<i>Real</i>	-32768.000...32767.000	-	1000 = 1
147.03	Data storage 3 real32	<i>Real</i>	-32768.000...32767.000	-	1000 = 1
147.04	Data storage 4 real32	<i>Real</i>	-32768.000...32767.000	-	1000 = 1
147.05	Data storage 5 real32	<i>Real</i>	-32768.000...32767.000	-	1000 = 1
147.06	Data storage 6 real32	<i>Real</i>	-32768.000...32767.000	-	1000 = 1
147.07	Data storage 7 real32	<i>Real</i>	-32768.000...32767.000	-	1000 = 1
147.08	Data storage 8 real32	<i>Real</i>	-32768.000...32767.000	-	1000 = 1
147.11	Data storage 1 int32	<i>Real</i>	-2147483648...2147483647	-	1 = 1
147.12	Data storage 2 int32	<i>Real</i>	-2147483648...2147483647	-	1 = 1
147.13	Data storage 3 int32	<i>Real</i>	-2147483648...2147483647	-	1 = 1
147.14	Data storage 4 int32	<i>Real</i>	-2147483648...2147483647	-	1 = 1
147.15	Data storage 5 int32	<i>Real</i>	-2147483648...2147483647	-	1 = 1
147.16	Data storage 6 int32	<i>Real</i>	-2147483648...2147483647	-	1 = 1
147.17	Data storage 7 int32	<i>Real</i>	-2147483648...2147483647	-	1 = 1
147.18	Data storage 8 int32	<i>Real</i>	-2147483648...2147483647	-	1 = 1
147.21	Data storage 1 int16	<i>Real</i>	-32768...32767	-	1 = 1
147.22	Data storage 2 int16	<i>Real</i>	-32768...32767	-	1 = 1
147.23	Data storage 3 int16	<i>Real</i>	-32768...32767	-	1 = 1
147.24	Data storage 4 int16	<i>Real</i>	-32768...32767	-	1 = 1
147.25	Data storage 5 int16	<i>Real</i>	-32768...32767	-	1 = 1
147.26	Data storage 6 int16	<i>Real</i>	-32768...32767	-	1 = 1
147.27	Data storage 7 int16	<i>Real</i>	-32768...32767	-	1 = 1
147.28	Data storage 8 int16	<i>Real</i>	-32768...32767	-	1 = 1
149 Panel port communication					
149.01	Node ID number	<i>Real</i>	1...32	-	1 = 1
149.03	Baud rate	<i>List</i>	1...5	-	1 = 1
149.04	Communication loss time	<i>Real</i>	0.3 ... 3000.0	s	10 = 1 s
149.05	Communication loss action	<i>List</i>	0...1	-	1 = 1
149.06	Refresh settings	<i>List</i>	0...1	-	1 = 1
150 FBA					
150.01	FBA A enable	<i>List</i>	0...3	-	1 = 1
150.02	FBA A comm loss func	<i>List</i>	0...5	-	1 = 1
150.03	FBA A comm loss t out	<i>Real</i>	0.3 ... 6553.5	s	10 = 1 s
150.07	FBA A act1 type	<i>List</i>	1...2	-	1 = 1
150.08	FBA A act2 type	<i>List</i>	1...2	-	1 = 1
150.10	FBA A act1 transparent source	<i>Analog src</i>	-	-	1 = 1
150.11	FBA A act2 transparent source	<i>Analog src</i>	-	-	1 = 1
150.12	FBA A debug mode	<i>List</i>	0...2	-	1 = 1

No.	Name	Type	Range	Unit	FbEq32
150.13	FBA A control word	<i>Data</i>	00000000h ... FFFFFFFFh	-	1 = 1
150.16	FBA A status word	<i>Data</i>	00000000h ... FFFFFFFFh	-	1 = 1
150.17	FBA A actual value 1	<i>Real</i>	-2147483648 ... 2147483647	-	1 = 1
150.18	FBA A actual value 2	<i>Real</i>	-2147483648 ... 2147483647	-	1 = 1
150.21	FBA A timelevel sel	<i>List</i>	0...3	-	1 = 1
150.31	FBA B enable	<i>List</i>	0...3	-	1 = 1
150.32	FBA B comm loss func	<i>List</i>	0...5	-	1 = 1
150.33	FBA B comm loss timeout	<i>Real</i>	0.3 ... 6553.5	s	10 = 1 s
150.37	FBA B act1 type	<i>List</i>	1...2	-	1 = 1
150.38	FBA B act2 type	<i>List</i>	1...2	-	1 = 1
150.40	FBA B act1 transparent source	<i>Analog src</i>	-	-	1 = 1
150.41	FBA B act2 transparent source	<i>Analog src</i>	-	-	1 = 1
150.42	FBA B debug mode	<i>List</i>	0...2	-	1 = 1
150.43	FBA B control word	<i>Data</i>	00000000h ... FFFFFFFFh	-	1 = 1
150.46	FBA B status word	<i>Data</i>	00000000h ... FFFFFFFFh	-	1 = 1
150.47	FBA B actual value 1	<i>Real</i>	-2147483648 ... 2147483647	-	1 = 1
150.48	FBA B actual value 2	<i>Real</i>	-2147483648 ... 2147483647	-	1 = 1
150.51	FBA B timelevel sel	<i>List</i>	0...3	-	1 = 1
151 FBA A settings					
151.01	FBA A type	<i>List</i>	-	-	1 = 1
151.02	FBA A Par2	<i>Real</i>	0...65535	-	1 = 1
...
151.26	FBA A Par26	<i>Real</i>	0...65535	-	1 = 1
151.27	FBA A par refresh	<i>List</i>	0...1	-	1 = 1
151.28	FBA A par table ver	<i>Data</i>	-	-	1 = 1
151.29	FBA A drive type code	<i>Real</i>	0...65535	-	1 = 1
151.30	FBA A mapping file ver	<i>Real</i>	0...65535	-	1 = 1
151.31	D2FBA A comm status	<i>List</i>	0...6	-	1 = 1
151.32	FBA A comm SW ver	<i>Data</i>	-	-	1 = 1
151.33	FBA A appl SW ver	<i>Data</i>	-	-	1 = 1
152 FBA A data in					
152.01	FBA A data in1	<i>List</i>	-	-	1 = 1
...
152.12	FBA A data in12	<i>List</i>	-	-	1 = 1
153 FBA A data out					
153.01	FBA data out1	<i>List</i>	-	-	1 = 1
...
153.12	FBA data out12	<i>List</i>	-	-	1 = 1
154 FBA B settings					
154.01	FBA B type	<i>List</i>	-	-	1 = 1
154.02	FBA B Par2	<i>Real</i>	0...65535	-	1 = 1
...
154.26	FBA B Par26	<i>Real</i>	0...65535	-	1 = 1
154.27	FBA B par refresh	<i>List</i>	0...1	-	1 = 1
154.28	FBA B par table ver	<i>Data</i>	-	-	1 = 1
154.29	FBA B drive type code	<i>Real</i>	0...65535	-	1 = 1
154.30	FBA B mapping file ver	<i>Real</i>	0...65535	-	1 = 1

154 Additional parameter data

No.	Name	Type	Range	Unit	FbEq32
154.32	FBA B comm SW ver	<i>Data</i>	-	-	1 = 1
154.33	FBA B appl SW ver	<i>Data</i>	-	-	1 = 1
155 FBA B data in					
155.01	FBA B data in1	<i>List</i>	-	-	1 = 1
...	
155.12	FBA B data in12	<i>List</i>	-	-	1 = 1
156 FBA B data out					
156.01	FBA B data out1	<i>List</i>	-	-	1 = 1
...	
156.12	FBA B data out12	<i>List</i>	-	-	1 = 1
160 DDCS communication					
160.41	Extension adapter com port	<i>List</i>	-	-	-
160.51	DDCS controller comm port	<i>List</i>	-	-	-
160.52	DDCS controller node address	<i>Real</i>	1...254	-	-
160.55	DDCS controller HW connection	<i>List</i>	0...1	-	-
160.57	DDCS controller link control	<i>Real</i>	1...15	-	-
160.58	DDCS controller comm loss time	<i>Real</i>	0...60000	ms	-
160.59	DDCS controller comm loss action	<i>List</i>	0...5	-	-
160.64	Mailbox dataset selection	<i>List</i>	0...1	-	-
161 DDCS transmit					
161.51	Data set 11 data 1 selection	<i>List</i>	-	-	-
161.52	Data set 11 data 2 selection	<i>List</i>	-	-	-
161.53	Data set 11 data 3 selection	<i>List</i>	-	-	-
161.54	Data set 13 data 1 selection	<i>List</i>	-	-	-
161.55	Data set 13 data 2 selection	<i>List</i>	-	-	-
161.56	Data set 13 data 3 selection	<i>List</i>	-	-	-
161.57	Data set 15 data 1 selection	<i>List</i>	-	-	-
161.58	Data set 15 data 2 selection	<i>List</i>	-	-	-
161.59	Data set 15 data 3 selection	<i>List</i>	-	-	-
161.60	Data set 17 data 1 selection	<i>List</i>	-	-	-
161.61	Data set 17 data 2 selection	<i>List</i>	-	-	-
161.62	Data set 17 data 3 selection	<i>List</i>	-	-	-
161.63	Data set 19 data 1 selection	<i>List</i>	-	-	-
161.64	Data set 19 data 2 selection	<i>List</i>	-	-	-
161.65	Data set 19 data 3 selection	<i>List</i>	-	-	-
161.66	Data set 21 data 1 selection	<i>List</i>	-	-	-
161.67	Data set 21 data 2 selection	<i>List</i>	-	-	-
161.68	Data set 21 data 3 selection	<i>List</i>	-	-	-
161.69	Data set 23 data 1 selection	<i>List</i>	-	-	-
161.70	Data set 23 data 2 selection	<i>List</i>	-	-	-
161.71	Data set 23 data 3 selection	<i>List</i>	-	-	-
161.72	Data set 25 data 1 selection	<i>List</i>	-	-	-
161.73	Data set 25 data 2 selection	<i>List</i>	-	-	-
161.74	Data set 25 data 3 selection	<i>List</i>	-	-	-
161.101	Data set 11 data 1 value	<i>Real</i>	0...65535	-	-

No.	Name	Type	Range	Unit	FbEq32
161.102	Data set 11 data 2 value	<i>Real</i>	0...65535	-	-
161.103	Data set 11 data 3 value	<i>Real</i>	0...65535	-	-
161.104	Data set 13 data 1 value	<i>Real</i>	0...65535	-	-
161.105	Data set 13 data 2 value	<i>Real</i>	0...65535	-	-
161.106	Data set 13 data 3 value	<i>Real</i>	0...65535	-	-
161.107	Data set 15 data 1 value	<i>Real</i>	0...65535	-	-
161.108	Data set 15 data 2 value	<i>Real</i>	0...65535	-	-
161.109	Data set 15 data 3 value	<i>Real</i>	0...65535	-	-
161.110	Data set 17 data 1 value	<i>Real</i>	0...65535	-	-
161.111	Data set 17 data 2 value	<i>Real</i>	0...65535	-	-
161.112	Data set 17 data 3 value	<i>Real</i>	0...65535	-	-
161.113	Data set 19 data 1 value	<i>Real</i>	0...65535	-	-
161.114	Data set 19 data 2 value	<i>Real</i>	0...65535	-	-
161.115	Data set 19 data 3 value	<i>Real</i>	0...65535	-	-
161.116	Data set 21 data 1 value	<i>Real</i>	0...65535	-	-
161.117	Data set 21 data 2 value	<i>Real</i>	0...65535	-	-
161.118	Data set 21 data 3 value	<i>Real</i>	0...65535	-	-
161.119	Data set 23 data 1 value	<i>Real</i>	0...65535	-	-
161.120	Data set 23 data 2 value	<i>Real</i>	0...65535	-	-
161.121	Data set 23 data 3 value	<i>Real</i>	0...65535	-	-
161.122	Data set 25 data 1 value	<i>Real</i>	0...65535	-	-
161.123	Data set 25 data 2 value	<i>Real</i>	0...65535	-	-
161.124	Data set 25 data 3 value	<i>Real</i>	0...65535	-	-
162 DDCS receive					
162.51	Data set 10 data 1 selection	<i>List</i>	-	-	-
162.52	Data set 10 data 2 selection	<i>List</i>	-	-	-
162.53	Data set 10 data 3 selection	<i>List</i>	-	-	-
162.54	Data set 12 data 1 selection	<i>List</i>	-	-	-
162.55	Data set 12 data 2 selection	<i>List</i>	-	-	-
162.56	Data set 12 data 3 selection	<i>List</i>	-	-	-
162.57	Data set 14 data 1 selection	<i>List</i>	-	-	-
162.58	Data set 14 data 2 selection	<i>List</i>	-	-	-
162.59	Data set 14 data 3 selection	<i>List</i>	-	-	-
162.60	Data set 16 data 1 selection	<i>List</i>	-	-	-
162.61	Data set 16 data 2 selection	<i>List</i>	-	-	-
162.62	Data set 16 data 3 selection	<i>List</i>	-	-	-
162.63	Data set 18 data 1 selection	<i>List</i>	-	-	-
162.64	Data set 18 data 2 selection	<i>List</i>	-	-	-
162.65	Data set 18 data 3 selection	<i>List</i>	-	-	-
162.66	Data set 20 data 1 selection	<i>List</i>	-	-	-
162.67	Data set 20 data 2 selection	<i>List</i>	-	-	-
162.68	Data set 20 data 3 selection	<i>List</i>	-	-	-
162.69	Data set 22 data 1 selection	<i>List</i>	-	-	-
162.70	Data set 22 data 2 selection	<i>List</i>	-	-	-
162.71	Data set 22 data 3 selection	<i>List</i>	-	-	-
162.72	Data set 24 data 1 selection	<i>List</i>	-	-	-
162.73	Data set 24 data 2 selection	<i>List</i>	-	-	-
162.74	Data set 24 data 3 selection	<i>List</i>	-	-	-
162.101	Data set 10 data 1 value	<i>Real</i>	0...65535	-	-

No.	Name	Type	Range	Unit	FbEq32
162.102	Data set 10 data 2 value	<i>Real</i>	0...65535	-	-
162.103	Data set 10 data 3 value	<i>Real</i>	0...65535	-	-
162.104	Data set 12 data 1 value	<i>Real</i>	0...65535	-	-
162.105	Data set 12 data 2 value	<i>Real</i>	0...65535	-	-
162.106	Data set 12 data 3 value	<i>Real</i>	0...65535	-	-
162.107	Data set 14 data 1 value	<i>Real</i>	0...65535	-	-
162.108	Data set 14 data 2 value	<i>Real</i>	0...65535	-	-
162.109	Data set 14 data 3 value	<i>Real</i>	0...65535	-	-
162.110	Data set 16 data 1 value	<i>Real</i>	0...65535	-	-
162.111	Data set 16 data 2 value	<i>Real</i>	0...65535	-	-
162.112	Data set 16 data 3 value	<i>Real</i>	0...65535	-	-
162.113	Data set 18 data 1 value	<i>Real</i>	0...65535	-	-
162.114	Data set 18 data 2 value	<i>Real</i>	0...65535	-	-
162.115	Data set 18 data 3 value	<i>Real</i>	0...65535	-	-
162.116	Data set 20 data 1 value	<i>Real</i>	0...65535	-	-
162.117	Data set 20 data 2 value	<i>Real</i>	0...65535	-	-
162.118	Data set 20 data 3 value	<i>Real</i>	0...65535	-	-
162.119	Data set 22 data 1 value	<i>Real</i>	0...65535	-	-
162.120	Data set 22 data 2 value	<i>Real</i>	0...65535	-	-
162.121	Data set 22 data 3 value	<i>Real</i>	0...65535	-	-
162.122	Data set 24 data 1 value	<i>Real</i>	0...65535	-	-
162.123	Data set 24 data 2 value	<i>Real</i>	0...65535	-	-
162.124	Data set 24 data 3 value	<i>Real</i>	0...65535	-	-
190 Additional actual values					
190.06	Main voltage U1-V1	<i>Real</i>	0.00...2000.00	V	100 = 1 V
190.07	Main voltage V1-W1	<i>Real</i>	0.00...2000.00	V	100 = 1 V
190.08	Main voltage W1-U1	<i>Real</i>	0.00...2000.00	V	100 = 1 V
190.40	Phase current U1	<i>Real</i>	0.00...30000.00	A	100 = 1 A
190.41	Phase current V1	<i>Real</i>	0.00...30000.00	A	100 = 1 A
190.42	Phase current W1	<i>Real</i>	0.00...30000.00	A	100 = 1 A
190.70	DC current 1	<i>Real</i>	0.00...30000.00	A	100 = 1 A
190.71	DC current 1 peak	<i>Real</i>	0.00...30000.00	A	100 = 1 A
190.72	DC current 1 fast	<i>Real</i>	0.00...30000.00	A	100 = 1 A
190.73	DC voltage 1 fast	<i>Real</i>	0.00...2000.00	V	100 = 1 V
190.74	Main voltage 1 fast	<i>Real</i>	0.00...2000.00	V	100 = 1 V
190.75	LSU status word 1	<i>PB</i>	0000h...FFFFh	-	1 = 1
192 Additional actual values 2					
192.06	Main voltage U2-V2	<i>Real</i>	0.00...2000.00	V	100 = 1 V
192.07	Main voltage V2-W2	<i>Real</i>	0.00...2000.00	V	100 = 1 V
192.08	Main voltage W2-U2	<i>Real</i>	0.00...2000.00	V	100 = 1 V
192.40	Phase current U2	<i>Real</i>	0.00...30000.00	A	100 = 1 A
192.41	Phase current V2	<i>Real</i>	0.00...30000.00	A	100 = 1 A
192.42	Phase current W2	<i>Real</i>	0.00...30000.00	A	100 = 1 A
192.70	DC current 2	<i>Real</i>	0.00...30000.00	A	100 = 1 A
192.71	DC current 2 peak	<i>Real</i>	0.00...30000.00	A	100 = 1 A
192.72	DC current 2 fast	<i>Real</i>	0.00...30000.00	A	100 = 1 A
192.73	DC voltage 2 fast	<i>Real</i>	0.00...2000.00	V	100 = 1 V
192.74	Main voltage 2 fast	<i>Real</i>	0.00...2000.00	V	100 = 1 V
192.75	LSU status word 2	<i>PB</i>	0000h...FFFFh	-	1 = 1

No.	Name	Type	Range	Unit	FbEq32
195 HW configuration					
195.01	Supply voltage	List	0...6	-	1 = 1
195.04	Control board supply	List	0...2	-	1 = 1
195.13	Reduced run mode	List	0...65535	-	1 = 1
195.14	Connected modules	PB	0000h...FFFFh	-	1 = 1
195.20	HW options word 1	PB	0000h...FFFFh	-	1 = 1
195.30	Parallel type list filter	List	0...3	-	1 = 1
195.31	Parallel connection rating id	List	-	-	1 = 1
195.40	DC voltage source	List	1...4	-	1 = 1
196 System					
196.01	Language	List	-	-	1 = 1
196.02	Pass code	Data	0...99999999	-	1 = 1
196.03	Access levels active	PB	0000h...FFFFh	-	1 = 1
196.06	Parameter restore	List	-	-	1 = 1
196.07	Parameter save manually	List	0...1	-	1 = 1
196.08	Control board boot	Real	0...1	-	1 = 1
196.20	Time sync primary source	List	0...9	-	1 = 1
196.24	Full days since 1st Jan 1980	Real	1...59999	-	1 = 1
196.25	Time in minutes within 24 h	Real	0...1439	-	1 = 1
196.26	Time in ms within one minute	Real	0...59999	-	1 = 1
196.29	Time sync source status	PB	0000h...FFFFh	-	1 = 1
196.61	User data logger status word	PB	0000h...FFFFh	-	1 = 1
196.63	User data logger trigger	Binary src	-	-	-
196.64	User data logger start	Binary src	-	-	-
196.65	Factory data logger time level	List	-	-	1 = 1
<i>(Parameters 196.100...196.102 only visible when enabled by parameter 196.02)</i>					
196.100	Change user pass code	Data	10000000...99999999	-	1 = 1
196.101	Confirm user pass code	Data	10000000...99999999	-	1 = 1
196.102	User lock functionality	PB	0000h...FFFFh	-	1 = 1
206 I/O bus configuration					
This parameter group contains parameters related to basic configuration of the distributed I/O bus. For details on the parameters in this group, see <i>ACS880 distributed I/O bus supplement</i> (3AXD50000126880 [English]).					
207 I/O bus service					
This parameter group contains parameters related to distributed I/O bus service. For details on the parameters in this group, see <i>ACS880 distributed I/O bus supplement</i> (3AXD50000126880 [English]).					
208 I/O bus diagnostics					
This parameter group contains parameters related to diagnostic counters of the distributed I/O bus. For details on the parameters in this group, see <i>ACS880 distributed I/O bus supplement</i> (3AXD50000126880 [English]).					
209 I/O bus fan identification					
This parameter group contains parameters related to fan identification run on the distributed I/O bus. For details on the parameters in this group, see <i>ACS880 distributed I/O bus supplement</i> (3AXD50000126880 [English]).					

7

Fault tracing

What this chapter contains

The chapter lists the warning and fault messages including possible causes and corrective actions. The causes of most warnings and faults can be identified and corrected using the information in this chapter. If not, an ABB service representative should be contacted.

Warnings and faults are listed below in separate tables. Each table is sorted by warning/fault code.

Safety



WARNING! Only qualified electricians are allowed to service the diode supply unit. Read the safety instructions in *Safety instructions for ACS880 multidrive cabinets and modules* (3AUA0000102301 [English]) for air-cooled modules, and *Safety instructions for ACS880 liquid-cooled multidrive cabinets and modules* (3AXD50000048633 [English]) for liquid-cooled modules before working on the diode supply unit.

Indications

■ Warnings and faults

Warnings and faults indicate an abnormal status. The codes and names of active warnings/faults are displayed on the control panel as well as the Drive composer PC tool. Only the codes of warnings/faults are available over fieldbus.

Warnings do not need to be reset; they stop showing when the cause of the warning ceases. After the cause of the fault has been corrected, the active fault can be reset from the control panel or Drive composer PC tool. The control panel can be in local or remote (external) control mode. When the fault has been removed, the diode supply unit can be restarted. Faults can also be reset from an external source selected by parameter [131.11 Fault reset selection](#).

Warning and fault indications can be directed to a relay output or a digital input/output by selecting [Warning](#), [Fault](#) or [Fault \(-1\)](#) in the source selection parameter. See sections

- [Programmable digital inputs and outputs](#) (page 22)
- [Programmable relay outputs](#) (page 22), and
- [Programmable relay outputs](#) (page 22).

■ Editable messages

For some warnings and faults, the message text can be edited and instructions and contact information added. To edit these messages, choose **Menu - Settings - Edit texts** on the control panel.

Warning/fault history and analysis

■ Event logs

The diode supply unit has two event logs that can be accessed from the main Menu on the control panel. The logs can also be accessed (and reset) using the Drive composer PC tool.

One of the logs contains faults and fault resets. The other log lists warnings and pure events, as well as clearing entries. Both logs contain the 64 most recent events. All indications are stored in the event logs with a time stamp and other information.

Auxiliary codes

Some events generate an auxiliary code that often helps in pinpointing the problem. The auxiliary code is displayed on the control panel together with the message. It is also stored in the event log details. In the Drive composer PC tool, the auxiliary code (if any) is shown in the event listing.

Factory data logger

The diode supply unit has a data logger that samples preselected values at 500-microsecond (default; see parameter [196.65 Factory data logger time level](#)) intervals. By default, approximately 700 samples recorded immediately before and after a fault are saved to the memory unit of the diode supply unit. The fault data of the last five faults is accessible in the event log when viewed in the Drive composer pro PC tool. (The fault data is not accessible through the control panel.)

For DxD modules, the values that are recorded in the factory data log are [106.01 Main control word](#), [106.11 Main status word](#), [110.01 DI status](#), [106.16 Drive status word 1](#) and [101.01 DC voltage](#). For DxT modules, the values that are recorded in the factory data log

are [190.74 Main voltage 1 fast](#), [190.73 DC voltage 1 fast](#), [190.72 DC current 1 fast](#), [106.11 Main status word](#), [190.75 LSU status word 1](#), [106.01 Main control word](#), [110.01 DI status](#). The selection of parameters cannot be changed by the user.

■ Other data loggers

User data logger

A custom data logger can be configured using the Drive composer pro PC tool. This functionality enables the free selection of up to eight parameters to be sampled at selectable intervals. The triggering conditions and the length of the monitoring period can also be defined by the user within the limit of approximately 8000 samples. In addition to the PC tool, the status of the logger is shown by parameter [196.61 User data logger status word](#). The triggering sources can be selected by parameters [196.63 User data logger trigger](#) and [196.64 User data logger start](#)). The configuration, status and collected data is saved to the memory unit for later analysis.

PSL2 data logger

The BCU control unit contains a data logger that collects data from the diode supply modules to help fault tracing and analysis. The data is saved onto the SD memory card attached to the BCU, and can be analyzed by ABB service personnel.

■ Parameters that contain warning/fault information

The codes of active warnings and faults (maximum five each), and five previously occurred warnings and faults are stored in the parameters of group [104 Warnings and faults](#) (page [45](#)).

Warning messages

Code (hex)	Warning	Cause	What to do
AE14	Excess temperature	Supply module heat sink temperature is excessive due to eg. module overload or fan failure. (Control program generates first a warning, then a fault.)	<p>Check module cooling air flow and fan operation.</p> <p>Check ambient temperature. If it exceeds 40 °C (104 °F), ensure that load current does not exceed derated load capacity. See appropriate <i>Hardware manual</i>.</p> <p>Check inside of cabinet and heat sink of the supply module for dust pick-up. Clean whenever necessary.</p> <p>Check the wiring and status of thermal switches inside the supply module(s).</p> <p>Check the auxiliary code (format XXXY YYZZ). "Y YY" specifies through which BCU control unit channel the fault was received. "ZZ" specifies the location (1: U-phase, 2: V-phase, 3: W-phase, 4: INT board, 5: Brake chopper, 6: Air inlet (sensor connected to INT board X10), 7: PCB compartment fan or power supply board, 8: du/dt filter or temperature switch (XT) (sensor connected to INT board X7), 9: Sensor connected to INT board X6, OFA: Ambient temperature).</p>
AE15	Excess temperature difference	High temperature difference between the semiconductors of different phases.	<p>Check the cabling.</p> <p>Check cooling of power module(s).</p> <p>Check the auxiliary code (format XXXY YYZZ). "XXX" indicates the source of difference (0: Single module, difference between phase IGBTs, 1: parallel-connected modules, minimum-maximum difference between all IGBTs of all modules). With parallel-connected modules, "Y YY" specifies through which BCU control unit channel the fault was received. "ZZ" specifies the phase (0: single module, 1: U-phase [parallel connection], 2: W-phase [parallel connection], 3: W-phase [parallel connection]).</p>
AE17	PU communication	Communication errors detected between the control unit and the power unit.	<p>Check the connections between the control unit and the power unit.</p> <p>Check the auxiliary code (format XXXY YYZZ). With parallel-connected modules, "Y YY" specifies the affected BCU control unit channel (0: broadcast). "ZZ" specifies the error source (8: Transmission errors in PSL link [see "XXX"], 9: Transmitter FIFO warning limit hit). "XXX" specifies the transmission error direction and detailed warning code (0: Rx/communication error, 1: Tx/Reed-Solomon symbol error, 2: Tx/no synchronization error, 3: Tx/Reed-Solomon decoder failures, 4: Tx/Manchester coding errors).</p>

Code (hex)	Warning	Cause	What to do
AE19	Measurement circuit temperature	Problem with internal temperature measurement.	Check the auxiliary code (format XXXY YYZZ). “Y YY” specifies through which BCU control unit channel the fault was received (“0 00” with a ZCU control unit). “ZZ” specifies the location (1 : U-phase IGBT, 2 : V-phase IGBT, 3 : W-phase IGBT, 4 : Power unit INT board, 5 : Brake chopper, 6 : Air inlet, 7 : Power supply board, 8 : du/dt filter, Fa : Air in temp).
AE1A	PU board powerfail	Power unit power supply failure.	Contact your local ABB representative.
AE1B	PU communication internal	Communication errors detected between the control unit and the power unit.	Check the connections between the control unit and the power unit.
AE1C	Measurement circuit ADC	Problem with measurement circuit of power unit (analog to digital converter)	Contact your local ABB representative.
AE1D	Measurement circuit DFF	Problem with current or voltage measurement of power unit.	Contact your local ABB representative.
AE1E	PU state feedback	State feedback from output phases does not match control signals.	Contact your local ABB representative.
AE21	Flash erase speed exceeded	The flash memory (in the memory unit) has been erased too frequently, compromising the lifetime of the memory.	Avoid forcing unnecessary parameter saves by parameter 196.07 or cyclic parameter writes (such as user logger triggering through parameters). Check the auxiliary code (format YYYY YZZZ). “X” specifies the source of warning (1 : generic flash erase supervision). “ZZZ” specifies the flash subsector number that generated the warning.
AE24	Voltage category unselected	The supply voltage range has not been defined.	Define supply voltage range (parameter 195.01 Supply voltage).
AE25	FBA A parameter conflict	The diode supply unit does not have a functionality requested by PLC, or requested functionality has not been activated.	Check PLC programming. Check settings of parameter groups 150 FBA and 151 FBA A settings .
AE26	FBA B parameter conflict	The diode supply unit does not have a functionality requested by PLC, or requested functionality has not been activated.	Check PLC programming. Check settings of parameter groups 150 FBA and 154 FBA B settings .
AE27	AI parametrization	The current/voltage jumper setting of an analog input does not correspond to parameter settings.	Check the auxiliary code. The code identifies the analog input whose settings are in conflict. Adjust either the hardware setting (on the control unit) or parameter 112.15 / 112.25 . Note: Control board reboot (either by cycling the power or through parameter 196.08 Control board boot) is required to validate any changes in the hardware settings.

Code (hex)	Warning	Cause	What to do
AE2E	Extension AI parameterization	The hardware current/voltage setting of an analog input (on an I/O extension module) does not correspond to parameter settings.	<p>Check the auxiliary code (format XX00 00YY). "XX" specifies the number of the I/O extension module (01: parameter group 114 Extension I/O module 1, 02: 115 Extension I/O module 2, 03: 116 Extension I/O module 3). "YY" specifies the analog input on the module.</p> <p>For example, in case of I/O extension module 1, analog input AI1 (auxiliary code 0000 0101), the hardware current/voltage setting on the module is shown by parameter 114.29. The corresponding parameter setting is 114.30. Adjust either the hardware setting on the module or the parameter to solve the mismatch.</p> <p>Note: Control board reboot (either by cycling the power or through parameter 196.08 Control board boot) is required to validate any changes in the hardware settings.</p>
AE2F	Extension I/O configuration failure	The I/O extension module types and locations specified by parameters do not match the detected configuration.	<p>Check the auxiliary code. The code indicates which I/O extension module is affected.</p> <p>Check the type and location settings of the modules (parameters 114.01, 114.02, 115.01, 115.02, 116.01 and 116.02).</p> <p>Check that the modules are properly installed.</p>
AE30	FB A communication Programmable warning: 150.02 FBA A comm loss func	Cyclical communication between diode supply unit and fieldbus adapter module A or between PLC and fieldbus adapter module A is lost.	<p>Check status of fieldbus communication. See user documentation of fieldbus interface.</p> <p>Check settings of parameter groups 150 FBA, 151 FBA A settings, 152 FBA A data in and 153 FBA A data out.</p> <p>Check cable connections.</p> <p>Check if communication master is able to communicate.</p>
AE31	FB B communication Programmable warning: 150.32 FBA B comm loss func	Cyclical communication between diode supply unit and fieldbus adapter module B or between PLC and fieldbus adapter module B is lost.	<p>Check status of fieldbus communication. See user documentation of fieldbus interface.</p> <p>Check settings of parameter groups 150 FBA, 154 FBA B settings, 155 FBA B data in and 156 FBA B data out.</p> <p>Check cable connections.</p> <p>Check if communication master is able to communicate.</p>
AE3E	Panel loss Programmable warning: 149.05 Communication loss action	Control panel (or PC tool) has stopped communicating.	<p>Check PC tool or control panel connection.</p> <p>Check control panel connector.</p> <p>Check mounting platform if being used.</p> <p>Disconnect and reconnect the control panel.</p>

Code (hex)	Warning	Cause	What to do
AE40	Output relay warning	Warning generated by an edge counter. Programmable warnings: 133.35 Edge count 1 warn sel 133.45 Edge count 2 warn sel	Check the event log for an auxiliary code. Check the source of the warning corresponding to the code: 2: 133.33 Edge count 1 src 3: 133.43 Edge count 2 src .
AE41	Supply unit starts warning		
AE42	Power ups warning		
AE43	Main contactor warning		
AE44	DC charge warning		
AE45	On-time 1 (Editable message text) Programmable warning: 133.14 On-time 1 warn sel	Warning generated by on-time timer 1.	Check the source of the warning (parameter 133.13 On-time 1 src).
AE46	On-time 2 (Editable message text) Programmable warning: 133.24 On-time 2 warn sel	Warning generated by on-time timer 2.	Check the source of the warning (parameter 133.23 On-time 2 src).
AE47	Edge counter 1 (Editable message text) Programmable warning: 133.35 Edge count 1 warn sel	Warning generated by edge counter 1.	Check the source of the warning (parameter 133.33 Edge count 1 src).
AE48	Edge counter 2 (Editable message text) Programmable warning: 133.45 Edge count 2 warn sel	Warning generated by edge counter 2.	Check the source of the warning (parameter 133.43 Edge count 2 src).
AE49	Value counter 1 (Editable message text) Programmable warning: 133.55 Value count 1 warn sel	Warning generated by value counter 1.	Check the source of the warning (parameter 133.53 Value count 1 src).
AE4A	Value counter 2 (Editable message text) Programmable warning: 133.65 Value count 2 warn sel	Warning generated by value counter 2.	Check the source of the warning (parameter 133.63 Value count 2 src).
AE4B	Device clean warning	Warning generated by an on-time timer. Programmable warnings: 133.14 On-time 1 warn sel 133.24 On-time 2 warn sel	Check the event log for an auxiliary code. Check the source of the warning corresponding to the code: 0: 133.13 On-time 1 src 1: 133.23 On-time 2 src 10: 105.04 Fan on-time counter .
AE4C	DC capacitor warning		
AE4D	Cabinet fan warning		
AE4E	Cooling fan warning		
AE4F	Additional cooling fan warning		
AE51	External warning 1 Programmable warning: 131.01 External event 1 source 131.02 External event 1 type	Fault in external device 1.	Check the external device. Check setting of parameter 131.01 External event 1 source .
AE52	External warning 2 (Editable message text) Programmable warning: 131.03 External event 2 source 131.04 External event 2 type	Fault in external device 2.	Check the external device. Check setting of parameter 131.03 External event 2 source .

Code (hex)	Warning	Cause	What to do
AE53	External warning 3 (Editable message text) Programmable warning: 131.05 External event 3 source 131.06 External event 3 type	Fault in external device 3.	Check the external device. Check setting of parameter 131.05 External event 3 source .
AE54	External warning 4 (Editable message text) Programmable warning: 131.07 External event 4 source 131.08 External event 4 type	Fault in external device 4.	Check the external device. Check setting of parameter 131.07 External event 4 source .
AE55	External warning 5 (Editable message text) Programmable warning: 131.09 External event 5 source 131.10 External event 5 type	Fault in external device 5.	Check the external device. Check setting of parameter 131.09 External event 5 source .
AE57	Autoreset	A fault is about to be autoreset.	Informative warning. See the settings in parameter group 131 Fault functions .
AE58	Emergency stop (off2)	Diode supply unit has received an emergency stop (mode selection off2) command.	Check that it is safe to continue operation. Return emergency stop push button to normal position.
AE59	Emergency stop (off1 or off3)	Diode supply unit has received an emergency stop (mode selection off1 or off3) command.	Restart the diode supply unit. If the emergency stop was unintentional, check the source of the stop signal (for example, 121.05 Emergency stop source , or control word received from an external control system).
AE5A	Enable start signal missing (Editable message text)	No enable start signal received.	Check the setting of (and the source selected by) parameter 120.19 Enable start signal .
AE5B	Run enable missing	No run enable signal is received.	Check setting of parameter 120.12 Run enable 1 . Switch signal on or check wiring of selected source.
AE5C	External power signal missing	195.04 Control board supply is set to External 24V but no voltage is connected to the XPOW connector of the control unit.	Check the external 24 V DC power supply to the control unit, or change the setting of parameter 195.04 Control board supply .
AE5F	Temperature warning	Supply module temperature is excessive due to eg. module overload or fan failure. (Control program generates first a warning, then a fault.)	Check module cooling air flow and fan operation. Check ambient temperature. If it exceeds 40 °C (104 °F), ensure that load current does not exceed derated load capacity. See appropriate <i>Hardware manual</i> . Check inside of cabinet and heatsink of supply module for dust pick-up. Clean whenever necessary. Check the wiring and status of thermal switches inside the cabinet.

Code (hex)	Warning	Cause	What to do
AE60	Control board temperature	Control unit temperature is excessive.	Check the auxiliary code. See actions for each code below.
	(none)	Temperature above warning limit	Check ambient conditions. Check air flow and fan operation. Check heatsink fins for dust pick-up.
	1	Thermistor broken	Contact an ABB service representative for control unit replacement.
AE61	Overvoltage	Short-time overvoltage in grid.	Check grid voltage for possible transient cause. Check the auxiliary code to identify the diode supply unit (15 : single diode supply unit or the first parallel-connected diode supply unit, 16 : the second parallel-connected diode supply unit).
AE62	Undervoltage	Grid voltage is not sufficient due to missing phase in supply connection, blown fuse or rectifier bridge internal fault.	Check supply and fuses. Check that parameter <i>195.01 Supply voltage</i> is set according to the supply voltage in use. Check the auxiliary code to identify the diode supply unit (15 : single diode supply unit or the first parallel-connected diode supply unit, 16 : the second parallel-connected diode supply unit).
AE67	AI supervision Programmable warning: <i>112.03 AI supervision function</i>	An analog signal is outside the limits specified for the analog input.	Check the event log for an auxiliary code (format XYY). "X" specifies the location of the input (0 : AI on control unit; 1 : I/O extension module 1, etc.), "YY" specifies the input and limit (01 : AI1 under minimum, 02 : AI1 over maximum, 03 : AI2 under minimum, 04 : AI2 over maximum). Check signal level at the analog input. Check the wiring connected to the input. Check the minimum and maximum limits of the input in parameter group <i>112 Standard AI, 114 Extension I/O module 1, 115 Extension I/O module 2 or 116 Extension I/O module 3</i> .
AE68	Emergency stop warning	Emergency stop warning is activated.	Check that it is safe to continue operation.
AE69	Synchronization	Synchronization to supply network has failed.	Check possible network asymmetry. Check the auxiliary code to identify the diode supply unit (15 : single diode supply unit or the first parallel-connected diode supply unit, 16 : the second parallel-connected diode supply unit).
AE6A	Current asymmetry	Positive and negative current in one phase are not equal.	One thyristor is not fired. Check thyristors and thyristor interface boards. Check the auxiliary code to identify the winding (15 : 6-pulse diode supply unit or the first winding of 12-pulse diode supply unit, 16 : the second winding of 12-pulse diode supply unit).
AE6B	Input phase lost	Missing phase in supply connection, blown fuse or rectifier bridge internal fault.	Check supply and fuses.

Code (hex)	Warning	Cause	What to do
AE6C	Semiconductor temperature	Diode temperature is excessive due to eg. module overload or fan failure. (Control program generates first a warning, then a fault.)	<p>Check ambient conditions.</p> <p>Check air flow and fan operation.</p> <p>Check heat sink fins for dust pick-up.</p> <p>Check motor power against diode supply unit power.</p> <p>Check the auxiliary code to identify the diode supply unit (15: single diode supply unit or the first parallel-connected diode supply unit, 16: the second parallel-connected diode supply unit).</p>
AE6D	DDCS controller comm loss Programmable warning: 160.59 DDCS controller comm loss action	DDCS (fiber optic) communication between the supply unit and external controller is lost.	<p>Check status of controller. See the user documentation of the controller.</p> <p>Check settings of parameter group 160 DDCS communication.</p> <p>Check cable connections. If necessary, replace cables.</p>
AE73	Fan	Cooling fan stuck or disconnected.	<p>Check the setting of parameter 195.20 HW options word 1, bit 13.</p> <p>Check the auxiliary code to identify the fan. Code 0 denotes main fan 1. Other codes (format XYZ): “X” specifies state code (1: ID run, 2: normal). “Y” specifies the index of the converter unit connected to BCU (0...n or 0...C, always 0 for ZCU control units). “Z” specifies the index of the fan (1: Main fan 1, 2: Main fan 2, 3: Main fan 3, 4: Auxiliary fan 1, 5: Auxiliary fan 2, 6: Auxiliary fan 3, 7: Filter fan 1, 8: Filter fan 2, 9: Filter fan 3).</p> <p>Check fan operation and connection.</p> <p>Replace fan if faulty.</p>
AE74	Current diff 12 pulse	The DC busbar currents of 12-pulse diode supply unit differ too much (27% of nominal by default).	<p>Check the DC fuses of DxT modules.</p> <p>Check that there are no loose connections in DC busbar.</p> <p>Check that the inductances of the windings are equal.</p> <p>Contact your local ABB representative if the limit needs to be changed.</p>
AE75	SD card	Error related to SD card used to store data.	Check the auxiliary code. See actions for each code below.
		1 No SD card	Insert a compatible, writable SD card into the SD CARD slot of the BCU control unit.
		2 SD card write-protected	
		3 SD card unreadable	
AE76	PCB space cooling	Temperature difference between ambient and module PCB space is excessive.	<p>Check the cooling fan inside the PCB space.</p> <p>With parallel-connected modules, check the auxiliary code (format XXXY YYZZ). “Y YY” specifies through which BCU control unit channel the fault was received.</p>

Code (hex)	Warning	Cause	What to do
AE79	Power fail saving	Power fail saving is requested too frequently. Due to the limited saving interval some of the requests do not trigger the saving and power fail data may be lost. This may be caused by DC voltage oscillation.	Check the supply voltage.
AE85	Charging count	There are too many DC link charging attempts.	Two attempts in five minutes is allowed to prevent charging circuit overheating.
AE87	Ext earth leakage	External earth fault triggered by input selected with parameter 131.28 Ext earth leakage signal source .	Check external earth fault source. Usually only one device is allowed in the same network. Check AC fuses. Check for earth leakages. Check supply cabling. Check power modules. Check there are no power factor correction capacitors or surge absorbers in supply cable. If no earth fault can be detected, contact your local ABB representative.
AE88	Parameter map configuration	Too much data in parameter mapping table created in Drive customizer.	See the <i>Drive customizer PC tool user's manual</i> (3AUA0000104167 [English]).
AE89	Mapped parameter value cut	Parameter value saturated eg. by the scaling specified in parameter mapping table (created in Drive customizer).	Check parameter scaling and format in parameter mapping table. See the <i>Drive customizer PC tool user's manual</i> (3AUA0000104167 [English]).
AE8A	User lock is open	The user lock is open, ie. user lock configuration parameters 196.100...196.102 are visible.	Close the user lock by entering an invalid pass code in parameter 196.02 Pass code . See section User lock (page 40).
AE8B	User pass code not confirmed	A new user pass code has been entered in parameter 196.100 but not confirmed in 196.101 .	Confirm the new pass code by entering the same code in 196.101 . To cancel, close the user lock without confirming the new code. See section User lock (page 40).
AE8C	Control unit battery	The battery of the control unit is low.	Replace control unit battery. This warning can be suppressed by using parameter 131.40 .
BE02	MCB maintenance notice	Main circuit breaker has worked too many times and it should be maintained according to the maintenance plan.	Maintain the main circuit breaker.

Fault messages

Code (hex)	Fault	Cause	What to do
2E00	Overcurrent	Too high inverter load or short circuit.	<p>Check supply voltage.</p> <p>Check that there are no power factor correction capacitors or surge absorbers in supply cable.</p> <p>Check motor load and acceleration times.</p> <p>Check power semiconductors (IGBTs) and current transducers.</p> <p>Check the auxiliary code (format XXXY YYZZ). With parallel-connected modules, "Y YY" specifies through which BCU control unit channel the fault was received. "ZZ" indicates the phase that triggered the fault (0: No detailed information available, 1: U-phase, 2: V-phase, 4: W-phase, 3/5/6/7: multiple phases).</p>
2E05	BU current difference	Phase current difference between parallel-connected modules.	<p>Check converter fuses.</p> <p>Check converter(s).</p> <p>Check inverter(s).</p> <p>Power off all boards.</p> <p>If the fault persists, contact your local ABB representative.</p> <p>Check the auxiliary code (format XXXY YYZZ). "XXX" specifies the source of the first error (see "YYY"). "YYY" specifies the module through which BCU control unit channel the fault was received (0: Channel 1, 1: Channel 2, 2: Channel 3, 4: Channel 4, 8: Channel 5, ..., 400: Channel 12, other: combinations of the above). "ZZ" indicates the phase (1: U, 2: V, 3: W).</p>
2E08	Ext earth leakage	External earth fault triggered by input selected with parameter 131.28 Ext earth leakage signal source .	See AE87 Ext earth leakage (page 169).
2E09	DC short circuit	There is a short-circuit in DC busbar.	<p>Check DC busbar.</p> <p>Check the auxiliary code to identify the diode supply unit (15: single diode supply unit or the first parallel-connected diode supply unit, 16: the second parallel-connected diode supply unit).</p>
2E0A	Current asymmetry	Positive and negative current in one phase are not equal.	<p>One thyristor is not fired. Check thyristors and thyristor interface boards. Check the auxiliary code to identify the winding (15: 6-pulse diode supply unit or the first winding of 12-pulse diode supply unit, 16: the second winding of 12-pulse diode supply unit).</p>

Code (hex)	Fault	Cause	What to do
2E0B	Current diff 12 pulse	The DC busbar currents of 12-pulse diode supply unit differ too much (40% of nominal by default).	Check the DC fuses of DxT modules. Check that there are not loose connections in DC busbar. Check that the inductances of the windings are equal. Contact your local ABB representative if the limit needs to be changed.
3E04	DC link overvoltage	Excessive intermediate circuit DC voltage	Check that parameter <i>195.01 Supply voltage</i> is set according to the supply voltage in use. Check the auxiliary code to identify the diode supply unit (15 : single diode supply unit or the first parallel-connected diode supply unit, 16 : the second parallel-connected diode supply unit).
3E05	DC link undervoltage	Intermediate circuit DC voltage is not sufficient due to missing mains phase, blown fuse or rectifier bridge internal fault.	Check the supply and fuses. Check that parameter <i>195.01 Supply voltage</i> is set according to the supply voltage in use.
3E06	BU DC link difference	Difference in DC voltages between parallel-connected diode supply modules.	Check the DC fuses. Check the connection to the DC bus. If the problem persists, contact your local ABB representative. Check the auxiliary code (format XXXY YYZZ). "XXX" specifies the source of the first error (see "YYY"). "YYY" specifies the module through which BCU control unit channel the fault was received (0 : Channel 1, 1 : Channel 2, 2 : Channel 3, 4 : Channel 4, 8 : Channel 5, ..., 400 : Channel 12).
3E07	BU voltage difference	Difference in main voltages between parallel-connected supply modules.	Check cable connections. Check the supply and fuses.
3E08	LSU charging	DC link voltage is not high enough after charging.	Check the supply and fuses. Check the event log for an auxiliary code. The auxiliary code identifies the event (see below). Check external charging tuning parameters <i>120.23... 120.50</i> . Check the connection from the relay output to the charging contactor. Check that the DC voltage measuring circuit is working correctly.
		1 Voltage rise is not acceptable.	Check parameter <i>120.26 Maximum dU/dt</i> .
		2 DC voltage level is not acceptable.	Check supply connection. Check parameter <i>195.01 Supply voltage</i> and parameter <i>120.25 MCB closing level</i> .
		4 Charging time is too high.	Check supply connections, voltage of power supply network and PSL2 link cable.

Code (hex)	Fault	Cause	What to do
		5 After closing the charging contactor, the voltage did not rise above 10% from nominal voltage in 0.2 seconds (can be set in service level).	Check the supply connection, and power unit must be externally powered to measure voltage.
		8 Parameter <i>120.28 MCB relay timing</i> is set too high. The DC voltage drops too low.	Check parameter <i>120.28 MCB relay timing</i> .
3E09	Charging count	There are too many DC link charging attempts.	Two attempts in five minutes is allowed to prevent charging circuit overheating.
3E0A	LSU charging busbar fault	The DC voltage rise in 10 ms is not acceptable during charging. The level is below the value set in parameter <i>120.26 Maximum dU/dt</i> , but DC voltage has not reached the level set in parameter <i>120.25 MCB closing level</i> .	Check the connections of the DC capacitors in the power modules and the parameters <i>120.25 MCB closing level</i> and parameter <i>120.26 Maximum dU/dt</i> .
3E0F	Synchronization	Synchronization to supply network has failed.	Check possible network asymmetry. Check the auxiliary code to identify the diode supply unit (15 : single diode supply unit or the first parallel-connected diode supply unit, 16 : the second parallel-connected diode supply unit). If the fault persists, contact your local ABB representative.
4E03	Excess temperature	Supply module heat sink temperature is excessive due to eg. module overload, fan failure or heatsink sensor. (Control program generates first a warning, then a fault.)	See <i>AE14 Excess temperature</i> (page 162).
4E04	Excess temperature difference	High temperature difference between the semiconductors of different phases. The amount of available temperatures depends on the frame size.	See <i>AE15 Excess temperature difference</i> (page 162).
4E06	Cabinet temperature fault	A measurement device connected to supply unit digital input or DI1 has tripped to a fault. Input is selected with parameter <i>131.33 Cabinet temperature fault source</i> . Excessive temperature of the busbars/fuses due to cabinet fan failure. Excessive temperature of the chokes inside the diode supply module due to a phase loss. Excessive temperature of the heat sink of the diode supply module due to module fan failure. (Control program generates first a warning, then a fault.)	Check parameter <i>131.34 Cabinet temperature supervision</i> . Check cabinet temperature source. Replace the cabinet fan. Check the input fuses and the input connection. Replace the module fan.
4E07	Control board temperature	High control board temperature.	Check proper cooling of the cabinet.

Code (hex)	Fault	Cause	What to do
4E08	Semiconductor temperature	Semiconductor temperature is excessive.	<p>Check ambient conditions.</p> <p>Check air flow and fan operation.</p> <p>Check heat sink fins for dust pick-up.</p> <p>Check motor power against diode supply unit power.</p> <p>Check the auxiliary code to identify the diode supply unit (15: single diode supply unit or the first parallel-connected diode supply unit, 16: the second parallel-connected diode supply unit).</p>
4E0A	PCB space cooling	Temperature difference between ambient and module PCB space is excessive.	See AE76 PCB space cooling (page 168).
5E00	Fan	Cooling fan stuck or disconnected.	See AE73 Fan (page 168).
5E03	XSTO circuit open	Circuit connected to XSTO:IN1 and/or XSTO:IN2 is open.	<p>Check XSTO circuit connections.</p> <p>See sections Default I/O connection diagram for DxD modules (ZCU) on page 31, and Default I/O connection diagram for DxT modules (BCU) on page 33.</p> <p>The auxiliary code contains location information. When converted into a 32-bit binary number, the bits of the code indicate the following:</p> <p>31...28: Number of faulty module (0...11 decimal), 1111: STO_ACT states of the control unit and the modules in conflict, 27: STO_ACT state of modules, 26: STO_ACT state of the control unit, 25: STO1 of the control unit, 24: STO2 of the control unit, 23...12: STO1 of modules 12...1 (bits of non-existing modules set to 1), 11...0: STO2 of modules 12...1 (bits of non-existing modules set to 1).</p> <p>For more information, see appropriate hardware manual.</p>
5E04	PU logic error	Power unit memory has cleared.	<p>Cycle the power to the supply unit. If the control unit is externally powered, also reboot the control unit (using parameter 196.08 Control board boot) or by cycling its power. If the problem persists, contact your local ABB representative.</p>

Code (hex)	Fault	Cause	What to do
5E05	Rating ID mismatch	The hardware of the supply unit does not match the information stored in the memory unit. This may occur eg. after a firmware update or memory unit replacement.	<p>Cycle the power to the supply unit.</p> <p>Check the auxiliary code. The auxiliary code categories are as follows:</p> <p>1 = PU and CU ratings not the same. Rating ID has changed.</p> <p>2 = Parallel connection rating ID has changed.</p> <p>3 = PU types not the same in all power units.</p> <p>4 = Parallel connection rating ID is active in a single power unit setup.</p> <p>5 = It is not possible to implement the selected rating with the current PUs.</p> <p>6 = PU rating ID is 0.</p> <p>7 = Reading PU rating ID or PU type failed on PU connection.</p> <p>8 = PU not supported (illegal rating ID).</p> <p>With parallel connection faults (BCU control unit), the format of the auxiliary code is 0X0Y. "Y" indicates the auxiliary code category, "X" indicates the first faulty PU channel in hexadecimal (1...C). (With a ZCU control unit, "X" can be 1 or 2 but this is irrelevant to the fault.)</p>
5E06	Main contactor fault	Control program does not receive main contactor on (1) acknowledgement through digital input even control program has closed the contactor control circuit with relay output. Main contactor / main breaker is not functioning properly, or there is a loose / bad connection.	<p>Check main contactor / main breaker control circuit wiring.</p> <p>Check the status of other switches connected to contactor control circuit. See the delivery-specific circuit diagrams.</p> <p>Check main contactor operating voltage level (should be 230 V).</p> <p>Check digital input DI3 connections.</p>
5E07	PU communication	The way the control unit is powered does not correspond to parameter setting.	Check setting of 195.04 Control board supply .
		Communication errors detected between the control unit and the power unit.	<p>Check the connection between the control unit and the power unit.</p> <p>Check the auxiliary code (format XXXY YYZZ). With parallel-connected modules, "Y YY" specifies the affected BCU control unit channel (0: broadcast). "ZZ" specifies the error source (1: Transmitter side [link error], 2: Transmitter side [no communication], 3: Receiver side [link error], 4: Receiver side [no communication], 5: Transmitter FIFO error [see "XXX"], 6: Module [xINT board] not found, 7: BAMU board not found). "XXX" specifies the transmitter FIFO error code (1: Internal error [invalid call parameter], 2: Internal error [configuration not supported], 3: Transmission buffer full).</p>
5E08	Power unit lost	Connection between the control unit and the power unit is lost.	Check the connection between the control unit and the power unit.

Code (hex)	Fault	Cause	What to do
5E09	PU communication internal	Internal communication error.	Contact your local ABB representative.
5E0A	Measurement circuit ADC	Measurement circuit fault.	Contact your local ABB representative, quoting the auxiliary code.
5E0B	PU board powerfail	Power unit power supply failure.	Check the auxiliary code (format ZZZY YYXX). “YY Y” specifies the affected module (0...C). “XX” specifies the affected power supply (1: Power supply 1, 2: Power supply 2, 3: both supplies).
5E0C	Measurement circuit DFF	Measurement circuit fault.	Contact your local ABB representative, quoting the auxiliary code.
5E0D	PU communication configuration	Version check cannot find a matching power unit FPGA logic, or number of connected power modules differs from specified.	If the number of connected power modules is correct (parameter 195.31 Parallel connection rating id), update the FPGA logic of the power unit. Cycle the power to the supply unit. If the control unit is externally powered, also reboot the control unit (using parameter 196.08 Control board boot) or by cycling its power. If the problem persists, contact your local ABB representative.
5E0E	Reduced run	Number of supply modules detected does not match the value of parameter 195.13 Reduced run mode , or the value of parameter 195.13 Reduced run mode indicates a configuration that is not possible or available. See section Reduced run function (page 38).	Check that the value of 195.13 Reduced run mode corresponds to the number of supply modules present. Check that the modules present are powered from the DC bus and connected by fiber optic cables to the BCU control unit. If all modules of the supply unit are in fact available (eg. maintenance work has been completed), check that parameter 195.13 is set to 0 (reduced run function disabled).
5E0F	PU state feedback	State feedback from output phases does not match control signals.	Contact your local ABB representative, quoting the auxiliary code.
5E10	Charging feedback	Charging feedback signal missing.	Check the feedback signal coming from the charging system.
5E11	Unknown PU fault	Unidentified power unit logic fault.	Check the logic and firmware compatibility. Contact your local ABB representative.
5E13	Auxiliary circuit breaker fault	Circuit breaker fault triggered by input selected with parameter 131.32 Aux circuit breaker fault source .	By default the feedback is connected to DI4.
5E14	Measurement circuit temperature	Problem with internal temperature measurement.	See AE19 Measurement circuit temperature (page 163).
5E17	Running fault of 12 pulse	The DxT modules connected to other winding of 12-pulse transformer are not started or running.	Check that the other breaker is closed properly. Check the fuses.
5E1A	Fuse trip	Fuse trip signal received.	Check the source of the fault (parameter 131.38 Fuse trip fault source).
5E1B	Brake chopper	Brake chopper fault signal received.	Check the source of the fault (parameter 131.39 Brake chopper fault source).

Code (hex)	Fault	Cause	What to do
6E00	FPGA version incompatible	Firmware and FPGA file version in the power unit are incompatible.	Reboot the control unit (using parameter 196.08 Control board boot) or by cycling power. If the problem persists, contact your local ABB representative.
		Update of power unit logic failed.	Retry.
6E01	FBA A mapping file	Fieldbus adapter A mapping file read error.	Contact your local ABB representative.
6E02	FBA B mapping file	Fieldbus adapter B mapping file read error.	Contact your local ABB representative.
6E03	Task overload	Internal fault. Note: This fault cannot be reset.	Reboot the control unit (using parameter 196.08 Control board boot) or by cycling power. If the problem persists, contact your local ABB representative.
6E04	Stack overflow	Internal fault. Note: This fault cannot be reset.	Reboot the control unit (using parameter 196.08 Control board boot) or by cycling power. If the problem persists, contact your local ABB representative.
6E05	Internal file load	File read error. Note: This fault cannot be reset.	Reboot the control unit (using parameter 196.08 Control board boot) or by cycling power. If the problem persists, contact your local ABB representative.
6E06	Internal record load	Internal record load error.	Contact your local ABB representative.
6E07	Application loading	Application file incompatible or corrupted. Note: This fault cannot be reset.	Contact your local ABB representative.
6E08	Memory unit detached	The memory unit was detached when the control unit was powered.	Switch off the power to the control unit and reinstall the memory unit. In case the memory unit was not actually removed when the fault occurred, check that the memory unit is properly inserted into its connector and its mounting screw is tight. Reboot the control unit (using parameter 196.08 Control board boot) or by cycling power. If the problem persists, contact your local ABB representative.
6E09	Internal SSW fault	Internal fault.	Reboot the control unit (using parameter 196.08 Control board boot) or by cycling power. If the problem persists, contact your local ABB representative.
6E0A	User set fault	Loading of the user parameter set failed because <ul style="list-style-type: none"> • requested set does not exist • set is not compatible with the control program • supply unit was switched off during loading. 	Ensure that a valid user parameter set exists. Reload.
6E0B	Kernel overload	Operating system error. Note: This fault cannot be reset.	Reboot the control unit (using parameter 196.08 Control board boot) or by cycling power. If the problem persists, contact your local ABB representative.
6E0C	Parameter system	Parameter load or save failed.	Try forcing a save using parameter 196.07 Parameter save manually . Retry.

Code (hex)	Fault	Cause	What to do
6E0D	FBA A parameter conflict	The diode supply unit does not have a functionality requested by PLC, or requested functionality has not been activated.	Check PLC programming. Check settings of parameter groups 150 FBA and 151 FBA A settings .
6E0E	FBA B parameter conflict	The diode supply unit does not have a functionality requested by PLC, or requested functionality has not been activated.	Check PLC programming. Check settings of parameter groups 150 FBA and 154 FBA B settings .
6E15	Text data overflow	Internal fault.	Reset the fault. Contact your local ABB representative if the fault persists.
6E16	Text 32-bit table overflow	Internal fault.	Reset the fault. Contact your local ABB representative if the fault persists.
6E17	Text 64-bit table overflow	Internal fault.	Reset the fault. Contact your local ABB representative if the fault persists.
6E18	Text file overflow	Internal fault.	Reset the fault. Contact your local ABB representative if the fault persists.
6E1A	Rating ID fault	Rating ID load error.	Contact your local ABB representative.
6E1B	Backup/Restore Timeout	A control panel or PC tool fails to communicate with the drive during backup or restoring operation.	Check the control panel or PC tool communication, and if it is still in backup/restore state.
6E1C	Emergency stop fault	Diode supply unit has received an emergency stop command.	Check that it is safe to continue operation. Return the emergency stop pushbutton to normal position. Restart the supply unit.
6E1D	Internal SW error	Internal error.	Contact your local ABB representative. Quote the auxiliary code (check the event details in the event log).
6E1F	Licensing fault	Running the control program is prevented either because a restrictive license exists, or because a required license is missing.	Record the auxiliary codes of all active licensing faults and contact your product vendor for further instructions.
6E20	Fault reset	Fault reset has been requested and done.	Informative fault.
7E00	Option module comm loss	Communication between the diode supply unit and an option module is lost.	Check that the option modules are properly seated in their slots. Check that the option modules or slot connectors are not damaged. To pinpoint the problem, try installing the modules into different slots.
7E01	Panel loss Programmable fault: 149.05 Communication loss action	Control panel (or PC tool) has stopped communicating.	Check PC tool or control panel connection. Check control panel connector. Disconnect and reconnect the control panel. Check the auxiliary code. The code specifies the I/O port used as follows: 0: Panel, 1: Fieldbus interface A, 2: Fieldbus interface B, 3: Ethernet, 4: D2D/EFB port).

Code (hex)	Fault	Cause	What to do
7E0B	FBA A communication Programmable fault: 150.02 FBA A comm loss func	Cyclical communication between diode supply unit and fieldbus adapter module A or between PLC and fieldbus adapter module A is lost.	Check status of fieldbus communication. See user documentation of fieldbus interface. Check settings of parameter groups 150 FBA , 151 FBA A settings , 152 FBA A data in and 153 FBA A data out . Check cable connections. Check if communication master is able to communicate.
7E0C	FBA B communication Programmable fault: 150.32 FBA B comm loss func	Cyclical communication between diode supply unit and fieldbus adapter module B or between PLC and fieldbus adapter module B is lost.	Check status of fieldbus communication. See user documentation of fieldbus interface. Check settings of parameter groups 150 FBA , 154 FBA B settings , 155 FBA B data in and 156 FBA B data out . Check cable connections. Check if communication master is able to communicate.
7E10	Ext I/O comm loss	The I/O extension module types specified by parameters do not match the detected configuration.	Check the event log for an auxiliary code (format XXYY YYYY). "XX" specifies the number of the I/O extension module (01: parameter group 114 Extension I/O module 1 , 02: 115 Extension I/O module 2 , 03: 116 Extension I/O module 3). "YY YYYY" indicates the problem (see actions for each code below).
	00 0001	Communication with module failed.	Check that the module is properly seated in its slot. Check that the module and the slot connector is not damaged. Try installing the module into another slot.
	00 0002	Module not found.	Check the type and location settings of the modules (parameters 114.01/114.02 , 115.01/115.02 or 116.01/116.02).
	00 0003	Configuration of module failed.	
	00 0004	Configuration of module failed.	Check that the module is properly seated in its slot. Check that the module and the slot connector is not damaged. Try installing the module into another slot.
7E11	DDCS controller comm loss Programmable fault: 160.59 DDCS controller comm loss action	DDCS (fiber optic) communication between the supply unit and external controller is lost.	Check status of controller. See the user documentation of the controller. Check settings of parameter group 160 DDCS communication . Check cable connections. If necessary, replace cables.
7E13	Incompatible option module	Option module not supported. (For example, type Fxxx-xx-M fieldbus adapter modules are not supported.)	Check the auxiliary code. The code specifies the interface to which the unsupported module is connected: 1 : Fieldbus interface A, 2 : Fieldbus interface B. Replace the module with a supported type.

Code (hex)	Fault	Cause	What to do
8E00	Overvoltage	Grid voltage is above 120% of the parameter <i>195.01 Supply voltage</i> for more than 0.5 seconds.	Check that parameter <i>195.01 Supply voltage</i> is set according to the supply voltage in use. Check the auxiliary code to identify the diode supply unit (15 : single diode supply unit or the first parallel-connected diode supply unit, 16 : the second parallel-connected diode supply unit).
8E06	AI supervision Programmable fault: <i>112.03 AI supervision function</i>	An analog signal is outside the limits specified for the analog input.	Check the event log for an auxiliary code (format XXXX XYZZ). "Y" specifies the location of the input (0 : Control unit, 1 : I/O extension module 1, 2 : I/O extension module 2, 3 : I/O extension module 3). "ZZ" specifies the limit (01 : AI1 under minimum, 02 : AI1 above maximum, 03 : AI2 under minimum, 04 : AI2 above maximum). Check signal level at the analog input. Check the wiring connected to the input. Check the minimum and maximum limits of the input in parameter group <i>112 Standard AI</i> .
9E01	External fault 1 (Editable message text) Programmable fault: <i>131.01 External event 1 source</i> <i>131.02 External event 1 type</i>	Fault in external device 1.	Check the external device. Check setting of parameter <i>131.01 External event 1 source</i> .
9E02	External fault 2 (Editable message text) Programmable fault: <i>131.03 External event 2 source</i> <i>131.04 External event 2 type</i>	Fault in external device 2.	Check the external device. Check setting of parameter <i>131.03 External event 2 source</i> .
9E03	External fault 3 (Editable message text) Programmable fault: <i>131.05 External event 3 source</i> <i>131.06 External event 3 type</i>	Fault in external device 3.	Check the external device. Check setting of parameter <i>131.05 External event 3 source</i> .
9E04	External fault 4 (Editable message text) Programmable fault: <i>131.07 External event 4 source</i> <i>131.08 External event 4 type</i>	Fault in external device 4.	Check the external device. Check setting of parameter <i>131.07 External event 4 source</i> .
9E05	External fault 5 (Editable message text) Programmable fault: <i>131.09 External event 5 source</i> <i>131.10 External event 5 type</i>	Fault in external device 5.	Check the external device. Check setting of parameter <i>131.09 External event 5 source</i> .
FE00	FB A force trip	A fault trip command has been received through fieldbus adapter A.	Check the fault information provided by the PLC.

Code (hex)	Fault	Cause	What to do
FE01	FB B force trip	A fault trip command has been received through fieldbus adapter B.	Check the fault information provided by the PLC.
FE03	Safe torque off 1 loss	Some STO connectors are not connected. Note: In diode supply units the STO connectors do not constitute a true safety function.	Check the auxiliary code. The code contains location information, especially with parallel-connected modules. When converted into a 32-bit binary number, the bits of the code indicate the following: 31...28: Number of faulty module (0...11 decimal). 1111: STO_ACT states of control unit and modules in conflict 27: STO_ACT state of modules 26: STO_ACT state of control unit 25: STO1 of control unit 24: STO2 of control unit 23...12: STO1 of modules 12...1 (Bits of non-existing modules set to 1) 11...0: STO2 of modules 12...1 (Bits of non-existing modules set to 1)
FE04	Safe torque off 2 loss	Some STO connectors are not connected. Note: In diode supply units the STO connectors do not constitute a true safety function.	



8

Fieldbus control through a fieldbus adapter

What this chapter contains

This chapter describes how the supply unit can be controlled by external devices over a communication network (fieldbus) through an optional fieldbus adapter module.

System overview

The user can control the diode supply unit through a fieldbus interface if the unit is equipped with an optional fieldbus adapter (for example, option +K454). Then the supply unit can be connected to an external control system through a serial communication link. The fieldbus adapter can be installed into any free slot on the control unit.

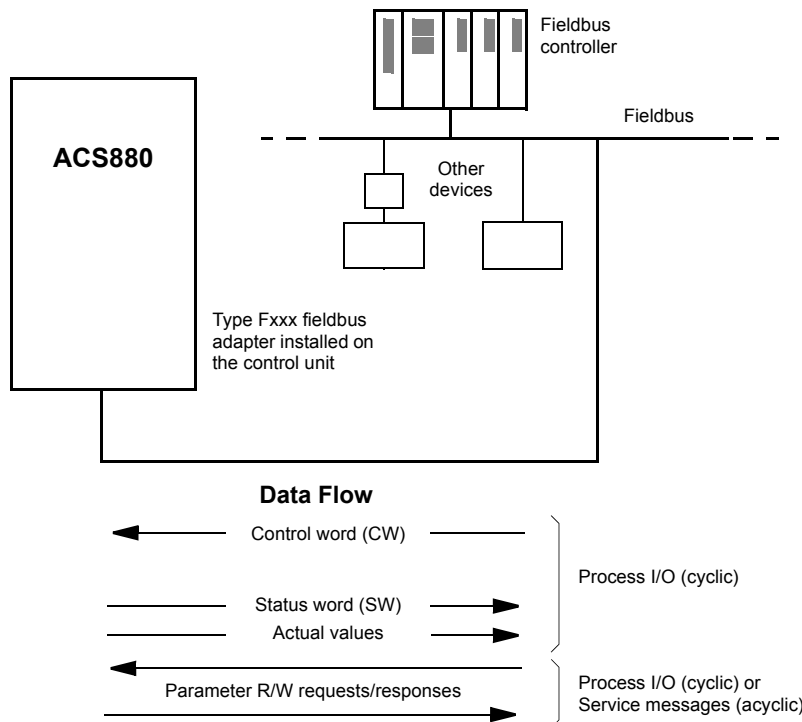

The diode supply unit can be set to receive its control information through the fieldbus interface, or the control can be distributed between the fieldbus interface and other available sources such as digital and analog inputs.

Fieldbus adapters are available for various serial communication systems and protocols, for example

- CANopen (FCAN-01 adapter)
- ControlNet (FCNA-01 adapter)
- DeviceNet (FDNA-01 adapter)
- EtherCAT (FECA-01 adapter)
- EtherNet/IP (FENA-11 or FENA-21 adapter)
- Modbus/RTU (FSCA-01 adapter)
- Modbus/TCP (FENA-11 or FENA-21 adapter)
- POWERLINK (FEPL-02 adapter)
- PROFIBUS DP (FPBA-01 adapter)
- PROFINET IO (FENA-11 or FENA-21 adapter).

Note: The text and examples in this chapter describe the configuration of one fieldbus adapter (FBA A) by parameters [150.01...150.21](#) and parameter groups 151...153. The second adapter (FBA B), if present, is configured in a similar fashion by parameters [150.31...150.51](#) and parameter groups 154...156.

Note: If FENA-xx Ethernet adapter is used for Ethernet tool network and Drive composer PC tool, use the FENA-xx adapter as fieldbus adapter B. Configure the FENA-xx adapter through parameters [150.31](#)...[150.51](#) and parameter groups 154...156. Normally, use the fieldbus adapter module as fieldbus adapter A. See *Ethernet tool network for ACS880 drives application guide* (3AUA0000125635 [English]), and *FENA-01/-11 Ethernet adapter module user's manual* (3AUA0000093568 [English]).

Basics of the fieldbus control interface

The cyclic communication between a fieldbus system and the diode supply unit consists of 16/32-bit input and output data words. The diode supply unit supports at the maximum the use of 12 data words (16 bits) in each direction.

Data transmitted from the diode supply unit to the fieldbus controller is defined by parameters [152.01 FBA A data in1](#) ... [152.12 FBA A data in12](#). The data transmitted from the fieldbus controller to the diode supply unit is defined by parameters [153.01 FBA data out1](#) ... [153.12 FBA data out12](#).

■ Control word and Status word

The Control word is the principal means for controlling the diode supply unit from a fieldbus system. It is sent by the fieldbus master station to the diode supply unit through the adapter module. The diode supply unit switches between its states according to the bit-coded instructions on the Control word, and returns status information to the master in the Status word.

The contents of the Control word and the Status word are detailed on pages [184](#) and [186](#) respectively.

If parameter [150.12 FBA A debug mode](#) is set to *Fast*, the Control word received from the fieldbus is shown by parameter [150.13 FBA A control word](#), and the Status word transmitted to the fieldbus network by [150.16 FBA A status word](#).

■ Actual values

Actual values are 16-bit words containing information on the operation of the diode supply unit.

If parameter [150.12 FBA A debug mode](#) is set to *Fast*, the actual values sent to the fieldbus are displayed by [150.17 FBA A actual value 1](#) and [150.18 FBA A actual value 2](#).

■ Contents of the fieldbus Control word

Bit	Name	Value	Description
0	ON/OFF	1	<p><u>DxD modules:</u> If either ON/OFF (bit 0) or Start (bit 3) is 1:</p> <ol style="list-style-type: none"> 1. Switch on the charging contactor 2. Charge. 3. Switch off the charging contactor, and switch on the main contactor/breaker. Charging is not in use in all units. See section Charging of DxD supply unit on page 35.
			<p><u>DxT modules:</u> If either ON/OFF (bit 0) or Start (bit 3) is 1:</p> <ol style="list-style-type: none"> 1. Close the main contactor/breaker and charge the DC busbar. 2. Ready to operate.
		0	If both ON/OFF (bit 0) or Start (bit 3) is 0: Switch off the charging contactor and the main contactor/breaker.
1	Off2 control	1	Continue operation (OFF2 inactive)
		0	Emergency stop, open main contactor
2	Off3 control	1	Continue operation (OFF3 inactive)
		0	Emergency stop, open main contactor
3	Start	1	<p><u>DxD modules:</u> If either ON/OFF (bit 0) or Start (bit 3) is 1:</p> <ol style="list-style-type: none"> 1. Switch on the charging contactor 2. Charge. 3. Switch off the charging contactor, and switch on the main contactor/breaker. Charging is not in use in all units. See section Charging of DxD supply unit on page 35.
			<p><u>DxT modules:</u> If either ON/OFF (bit 0) or Start (bit 3) is 1:</p> <ol style="list-style-type: none"> 1. Close the main contactor/breaker and charge the DC busbar. 2. Ready to operate.
		0	If both Run (bit 0) or Start (bit 3) is 0: Switch off the charging contactor and the main contactor/breaker.
4	-	1	Not in use.
		0	Not in use.
5	-	1	Not in use.
		0	Not in use.
6	-	1	Not in use.
		0	Not in use.
7	Reset	0=>1	Fault reset if an active fault exists.
		0	- (no reset)
8	-	1	Not in use.
		0	Not in use.
9	-	1	Not in use.
		0	Not in use.
10	Remote cmd	1	Control location: REMOTE (EXT1 or EXT2).
		0	Control location: LOCAL.
11	Ext ctrl loc	1	Select External Control Location EXT2. Effective if control location is parameterized to be selected from fieldbus.
		0	Select External Control Location EXT1. Effective if control location is parameterized to be selected from fieldbus.
12	User bit 0	1	User bit 0 from external control location.
		0	User bit 0 from external control location.

Bit	Name	Value	Description
13	User bit 1	1	User bit 1 from external control location.
		0	User bit 1 from external control location.
14	User bit 2	1	User bit 2 from external control location.
		0	User bit 2 from external control location.
15	User bit 3	1	User bit 3 from external control location.
		0	User bit 3 from external control location.

■ Contents of the fieldbus Status word

Bit	Name	Value	Description
0	Ready to switch ON	1	Ready to switch ON Note: If the supply unit is switched off, the Start enable must be on for Ready to switch ON = 1. If the supply unit is switched on, Ready to switch ON = 1 regardless of the Start enable.
		0	Not ready to switch ON
1	Ready run	1	Ready to operate. Start command is on and main contactor is closed.
		0	Start command is not given or main contactor is open.
2	Ready ref	1	Operation enabled
		0	Operation inhibited
3	Tripped	1	Fault
		0	No fault active
4	-	1	Not in use.
		0	Not in use.
5	-	1	Not in use.
		0	Not in use.
6	-	1	Not in use.
		0	Not in use.
7	Warning	1	A warning is active
		0	No warnings active
8	Operating	1	Thyristors of the DxT module are modulating, during charging or when the supply unit is running. During charging, thyristors are already conducting, but DC voltage has not yet risen to 'Ready ref' level.
		0	Thyristors of the DxT module are not modulating.
9	Remote	1	Control location: REMOTE (EXT1 or EXT2).
		0	Control location: LOCAL.
10	Ready for load	1	Ready for load.
		0	Not ready for load.
11	User bit 0	1	See parameter 106.30 MSW bit 11 sel.
		0	See parameter 106.30 MSW bit 11 sel.
12	User bit 1	1	See parameter 106.31 MSW bit 12 sel.
		0	See parameter 106.31 MSW bit 12 sel.
13	User bit 2	1	See parameter 106.32 MSW bit 13 sel.
		0	See parameter 106.32 MSW bit 13 sel.
14	Charging	1	Charging state is active. See section Charging of DxD supply unit on page 35.
		0	Charging state is not active. See section Charging of DxD supply unit on page 35.
15	User bit 3	1	See parameter 106.33 MSW bit 15 sel.
		0	See parameter 106.33 MSW bit 15 sel.

Setting up the diode supply unit for fieldbus control

Before configuring the diode supply unit for fieldbus control, the adapter module must be mechanically and electrically installed according to the instructions given in the *User's manual* of the appropriate fieldbus adapter module.

Note: To be able to switch the main contactor and the supply unit on and off through the fieldbus, the Run enable command at the digital input DI2 (by default) must be on (1). That is the case when the operating switch [S11] is switched to the on (1) position.

1. Power up the diode supply unit.
 2. Enable the communication between the diode supply unit and the fieldbus adapter module by setting parameter *150.01 FBA A enable* to *Option slot 1*.
 3. With *150.02 FBA A comm loss func*, select how the diode supply unit should react to a fieldbus communication break.
Note: This function monitors both the communication between the fieldbus master and the adapter module and the communication between the adapter module and the diode supply unit.
 4. With *150.03 FBA A comm loss t out*, define the time between communication break detection and the selected action.
 5. Select application-specific values for the rest of the parameters in group *150 FBA*.
 6. Set the fieldbus adapter module configuration parameters in group *151 FBA A settings*. At the minimum, set the required node address and the communication profile. Set profile to transparent 16 mode.
Note: The parameter indexes and names vary as the way the different fieldbus adapters use these parameters.
Example: For the FPBA adapter, set parameter *151.05 Profile* to mode *Trans16*.
 7. Define the process data transferred to and from the diode supply unit in parameter groups *152 FBA A data in* and *153 FBA A data out*.
Note: The adapter module sets the Status word and Control word automatically into parameters *152.01* and *153.01* respectively.
 8. Save the valid parameter values to permanent memory by setting parameter *196.07 Parameter save manually* to *Save*.
 9. Validate the settings made in parameter groups 151, 152 and 153 by setting parameter *151.27 FBA A par refresh* to *Configure*.
 10. Select the fieldbus adapter A as the source of the start and stop commands for external control location EXT1 by setting parameter *120.01 Ext1 commands* to *Fieldbus A*.
 11. Set the relevant control parameters to control the diode supply unit according to the application.
-

Setting up the communication between DSU and inverter unit

Connect the fiber optic cables between the DDCS communication port of the inverter unit (parameter 60.71 INU-LSU communication port) and the DDCS controller port of the DSU (parameter [160.51 DDCS controller comm port](#)). For example, in the DSU, slot 3A is used with the ZCU control unit and, in the inverter unit, channel CH1 of the RDCO connector unit in the BCU-x2 control unit.

In ACS880-07 drives, setting the DSU parameter [195.20 HW options word 1](#) bit 11 to Yes automatically sets the following DSU parameters to their right values:

DSU parameter	Setting
120.01 Ext1 commands	<i>DDCS controller</i>
120.02 Ext1 start trigger	<i>Level</i>
120.12 Run enable 1	<i>DI2</i>
160.58 DDCS controller comm loss time	Set time, eg. 100 ms.
160.51 DDCS controller comm port	Set port to be used. Eg. slot 3A is used with the ZCU control unit, and RDCO CH0 is used with the BCU control unit.
161.51 Data set 11 data 1 selection	<i>SW 16bit</i>
162.51 Data set 10 data 1 selection	<i>CW 16bit</i>

In ACS880-07 drives, setting the INU parameter [95.20 HW options word 1](#) bit 11 to Yes automatically sets the following INU parameters to their right values:

Inverter unit parameter	Setting
60.71 INU-LSU communication port	RDCO CH1
60.81 LSU control	On
61.151 INU-LSU data set 10 data 1 sel	LSU CW
62.151 INU-LSU data set 11 data 1 sel	SW 16bit

In the diode supply unit, data transmitted from the diode supply unit is defined with parameters [161.51 Data set 11 data 1 selection](#)...[161.74 Data set 25 data 3 selection](#). Data is received using parameters [162.51 Data set 10 data 1 selection](#)...[162.74 Data set 24 data 3 selection](#).

In the inverter unit, data transmitted to the diode supply unit is defined with parameters 61.151...61.186. Data is received using parameters 62.151...62.174.

With the settings above, the inverter unit controls the diode supply unit. In other words, the diode supply unit receives the Control word from the inverter unit and transmits the Status word to the inverter unit.

Note: The control program still requires the Run enable command from digital input DI2 (by default) which is normally wired to the DSU door switch.



Drive-to-drive link

This feature is not supported by the current firmware version.

Further information

Product and service inquiries

Address any inquiries about the product to your local ABB representative, quoting the type designation and serial number of the unit in question. A listing of ABB sales, support and service contacts can be found by navigating to www.abb.com/searchchannels.

Product training

For information on ABB product training, navigate to new.abb.com/service/training.

Providing feedback on ABB manuals

Your comments on our manuals are welcome. Navigate to new.abb.com/drives/manuals-feedback-form.

Document library on the Internet

You can find manuals and other product documents in PDF format on the Internet at www.abb.com/drives/documents.

Contact us

www.abb.com/drives

www.abb.com/drivespartners

3AUA0000103295 Rev F (EN) 2017-06-09